

Specification

Open Protocol

Atlas Copco Industrial Technique AB

9836 4415 01
Specification Release 2.20.1

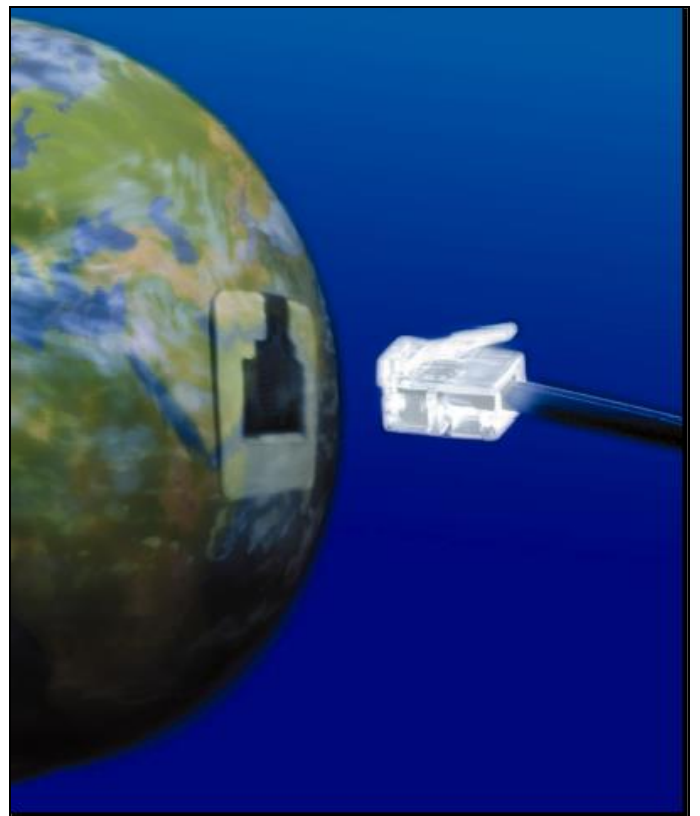

Copyright Atlas Copco Industrial Technique AB

Note! This manual can be altered without further notice.

For further information log in to Atlas Copco www.atlascopco.com

1	Introduction	13
1.1	Revision history	13
1.2	Referenced documents	20
1.3	Protocol and Specification Versioning	21
1.4	Terminology.....	22
2	Using Open Protocol	25
2.1	Communication	25
2.1.1	Transport protocol.....	26
2.1.2	Serial protocol.....	27
2.2	Message structure	30
2.2.2	Header.....	31
2.2.3	New MID numbers use from OP 2.0.....	32
2.2.4	MID with both ASCII and binary data from OP 2.0.....	33
2.2.5	Sequence number functionality from OP spec. 2.0.....	33
2.2.6	Message linking functionality from OP spec 2.0	35
2.3	Static Data Field use	35
2.3.1	Static Data field implementation rules.....	36
2.4	Variable data field use from OP spec 2.0	37
2.4.1	Message End.....	38
3	Implementation guidelines and Communication	39
3.1	Application Startup messages exchange.....	39
3.2	Message acknowledging methods	39
3.2.1	Application Level acknowledging method.....	40
3.2.2	Link Level acknowledging method from OP spec. 2.0	41
3.3	Establishing contact.....	46
3.3.1	Ethernet connection.....	46
3.3.2	Serial connection	47
3.3.3	Serial connection with 3964R	48
3.3.4	Session control connections	49
3.3.5	Retransmission rules	50
3.4	Starting a subscription	51
3.5	Sending a request	52
3.6	Sending a command.....	53
3.7	MES ruled production message sequences	54
3.7.1	General Job/Work order selection rules.....	54
3.7.2	Production Control by Pset selection and tightening.....	56
3.7.3	Production control by Job selection and tightening.....	60
3.8	Message End determination methods	63
3.9	Version 2.0 implementation description.....	63
3.9.1	Startup	63
3.9.2	Link level acknowledging.....	63
3.9.3	Generic Application data request.....	63
3.9.4	Generic Application data subscription.....	64
3.9.5	Data field variable parameter pattern.....	64
4	Message categories.....	66
4.1	Application Request and Request reply messages	66
4.1.1	Generic Request message	66
4.2	Application Command and Command reply messages	66
4.3	Application Subscription Messages	67
4.3.1	Event data Subscribe/ Unsubscribe messages.....	67
4.3.2	Subscribed data messages	67
4.3.3	Subscribed data message acknowledge	67
4.3.4	Generic Subscription/Unsubscription messages.....	67

4.3.5	Subscription/Unsubscription messages handling when sequence numbering and Link level acknowledging is used.....	67
4.4	Programming control	68
4.5	Message list	69
4.6	Implemented Messages from the list	74
5	All messages	75
5.1	Application Link Communication messages	75
5.1.1	MID 9998 Communication acknowledge error	75
5.1.2	MID 9997 Communication acknowledge	75
5.2	Application Communication messages.....	76
5.2.1	MID 0001 Application Communication start	76
5.2.2	MID 0002 Application Communication start acknowledge	77
5.2.3	MID 0003 Application Communication stop	80
5.2.4	MID 0004 Application Communication negative acknowledge	81
5.2.5	MID 0005 Application Communication positive acknowledge	85
5.2.6	MID 0006 Application data message request	86
5.2.7	MID 0008 Application data message subscription	87
5.2.8	MID 0009 Application Data Message unsubscribe	88
5.3	Application Parameter Set Messages.....	89
5.3.1	MID 0010 Parameter set ID upload request	89
5.3.2	MID 0011 Parameter set ID upload reply.....	89
5.3.3	MID 0012 Parameter set data upload request	90
5.3.4	MID 0013 Parameter set data upload reply	90
5.3.5	MID 0014 Parameter set selected subscribe	92
5.3.6	MID 0015 Parameter set selected	93
5.3.7	MID 0016 Parameter set selected acknowledge.....	95
5.3.8	MID 0017 Parameter set selected unsubscribe	95
5.3.9	MID 0018 Select Parameter set.....	95
5.3.10	MID 2504 Select Parameter set, Dynamic Job Included	96
5.3.11	MID 2505 Select Parameter set dynamically.....	96
5.3.12	MID 0019 Set Parameter set batch size.....	97
5.3.13	MID 0020 Reset Parameter set batch counter	98
5.3.14	MID 0021 Lock at batch done subscribe	98
5.3.15	MID 0022 Lock at batch done upload.....	99
5.3.16	MID 0023 Lock at batch done upload Acknowledge.....	99
5.3.17	MID 0024 Lock at batch done unsubscribe	99
5.3.18	MID 0025 Parameter user set download request	99
5.3.19	MID 2500 Tightening Program Message download.....	100
5.3.20	MID 2501 Tightening Program Message Upload.....	111
5.3.21	MID 2506 Tightening Program Delete	112
5.4	Application Mode MIDs.....	113
5.4.1	Functionality.....	113
5.4.2	MID 2600 Mode ID upload request	115
5.4.3	MID 2601 Mode ID upload reply	115
5.4.4	MID 2602 Mode data upload request.....	115
5.4.5	MID 2603 Mode data upload reply.....	116
5.4.6	MID 2604 Mode selected.....	116
5.4.7	MID 2605 Mode selected acknowledge	117
5.4.8	MID 2606 Select Mode	117
5.5	Application Job messages.....	118
5.5.1	MID 0030 Job ID upload request	118
5.5.2	MID 0031 Job ID upload reply	118
5.5.3	MID 0032 Job data upload request.....	119
5.5.4	MID 0033 Job data upload reply	120
5.5.5	MID 0034 Job info subscribe	125
5.5.6	MID 0035 Job info.....	125
5.5.7	MID 0036 Job info acknowledge.....	130
5.5.8	MID 0037 Job info unsubscribe	130
5.5.9	MID 0038 Select Job	130

5.5.10	MID 0039 Job restart.....	131
5.6	Application Tool messages.....	132
5.6.1	MID 0040 Tool data upload request.....	132
5.6.2	MID 0041 Tool data upload reply.....	132
5.6.3	MID 0042 Disable tool.....	136
5.6.4	MID 0043 Enable tool.....	137
5.6.5	MID 0044 Disconnect tool request.....	137
5.6.6	MID 0045 Set calibration value request.....	137
5.6.7	MID 0046 Set primary tool request.....	138
5.6.8	MID 0047 Tool Pairing handling.....	139
5.6.9	MID 0048 Tool Pairing status.....	140
5.6.10	MID 0700 Tightening data download status.....	141
5.6.11	MID 0701 Tool list upload reply.....	141
5.6.12	MID 0702 Tool Data upload reply with generic data.....	142
5.6.13	MID 0703 Set calibration value request with generic data.....	142
5.6.14	MID 0704 Tool Data status reply with generic data.....	144
5.7	Application VIN Messages.....	146
5.7.1	MID 0050 Vehicle ID Number download request.....	146
5.7.2	MID 0051 Vehicle ID Number subscribe.....	146
5.7.3	MID 0052 Vehicle ID Number.....	146
5.7.4	MID 0053 Vehicle ID Number acknowledge.....	148
5.7.5	MID 0054 Vehicle ID Number unsubscribe.....	148
5.8	Application Tightening result messages.....	149
5.8.1	MID 0060 Last tightening result data subscribe.....	149
5.8.2	MID 0061 Last tightening result data.....	149
5.8.3	MID 0062 Last tightening result data acknowledge.....	163
5.8.4	MID 0063 Last tightening result data unsubscribe.....	163
5.8.5	MID 0064 Old tightening result upload request.....	164
5.8.6	MID 0065 Old tightening result upload reply.....	164
5.8.7	MID 0066 Number of offline results.....	175
5.8.8	MID 0067 Tightening Result List Upload.....	176
5.8.9	MID 0900 Trace curve data message.....	177
5.8.10	MID 0901 Traces Plot Parameters Message.....	188
5.8.11	MID 0902 Tightening Result DB Info Upload.....	192
5.9	Application result messages with variables.....	193
5.9.1	MID 1201 Operation result Overall data.....	194
5.9.2	MID 1202 Operation result object data.....	199
5.9.3	MID 1203 Operation result data acknowledge.....	200
5.9.4	Examples.....	201
5.10	Application Alarm messages.....	206
5.10.1	MID 0070 Alarm subscribe.....	206
5.10.2	MID 0071 Alarm.....	206
5.10.3	MID 0072 Alarm acknowledge.....	208
5.10.4	MID 0073 Alarm unsubscribe.....	208
5.10.5	MID 0074 Alarm acknowledged on controller.....	209
5.10.6	MID 0075 Alarm acknowledged on controller acknowledge.....	209
5.10.7	MID 0076 Alarm status.....	209
5.10.8	MID 0077 Alarm status acknowledge.....	211
5.10.9	MID 0078 Acknowledge alarm remotely on controller.....	211
5.10.10	MID 1000 Alarm.....	211
5.10.11	MID 1001 Alarm acknowledge.....	212
5.11	Application Time messages.....	213
5.11.1	MID 0080 Read time upload request.....	213
5.11.2	MID 0081 Read time upload reply.....	213
5.11.3	MID 0082 Set Time.....	213
5.12	Application Multi-spindle status messages.....	213
5.12.1	MID 0090 Multi-spindle status subscribe.....	214
5.12.2	MID 0091 Multi-spindle status.....	214
5.12.3	MID 0092 Multi-spindle status acknowledge.....	215
5.12.4	MID 0093 Multi-spindle status unsubscribe.....	215

5.13	Application Multi-spindle result messages.....	216
5.13.1	MID 0100 Multi-spindle result subscribe.....	216
5.13.2	MID 0101 Multi-spindle result.....	217
5.13.3	MID 0102 Multi-spindle result acknowledge.....	225
5.13.4	MID 0103 Multi spindle result unsubscribe.....	225
5.13.5	MID 0104 Old Multi spindle result request.....	225
5.14	Application PowerMACS result data	226
5.14.1	MID 0105 Last PowerMACS tightening result data subscribe	226
5.14.2	MID 0106 Last PowerMACS tightening result Station data	227
5.14.3	MID 0107 Last Power MACS tightening result Bolt data	233
5.14.4	MID 0108 Last Power MACS tightening result data acknowledge.....	241
5.14.5	MID 0109 Last Power MACS tightening result data unsubscribe	241
5.15	Application User interface messages	242
5.15.1	MID 0110 Display user text on compact.....	242
5.15.2	MID 0111 Display user text on graph	242
5.15.3	MID 0113 Flash green light on tool.....	243
5.16	Application Job messages, advanced	244
5.16.1	MID 0120 Job line control info subscribe.....	244
5.16.2	MID 0121 Job line control started.....	244
5.16.3	MID 0122 Job line control alert 1	244
5.16.4	MID 0123 Job line control alert 2.....	244
5.16.5	MID 0124 Job line control done.....	245
5.16.6	MID 0125 Job line control info acknowledge	245
5.16.7	MID 0126 Job line control info unsubscribe.....	245
5.16.8	MID 0127 Abort Job	245
5.16.9	MID 0128 Job batch increment.....	245
5.16.10	MID 0129 Job batch decrement	246
5.16.11	MID 0130 Job off.....	246
5.16.12	MID 0131 Set Job line control start	246
5.16.13	MID 0132 Set Job line alert 1	247
5.16.14	MID 0133 Set Job line alert 2	247
5.16.15	MID 0140 Execute dynamic Job request.....	247
5.17	Application Multiple identifiers messages.....	257
5.17.1	MID 0150 Identifier download request.....	257
5.17.2	MID 0151 Multiple identifier and result parts subscribe	257
5.17.3	MID 0152 Multiple identifier and result parts	257
5.17.4	MID 0153 Multiple identifiers and result parts acknowledge.....	258
5.17.5	MID 0154 Multiple identifier and result parts unsubscribe	258
5.17.6	MID 0155 Bypass Identifier	259
5.17.7	MID 0156 reset latest Identifier.....	259
5.17.8	MID 0157 reset all Identifiers.....	259
5.17.9	MID 1601 Dynamic identifier message.....	259
5.17.10	MID 1602 Dynamic identifier data acknowledge.....	262
5.17.11	Example of use, MID 1601	262
5.18	Application I/O Interface	264
5.18.1	MID 0200 Set externally controlled relays	264
5.18.2	MID 0210 Status externally monitored inputs subscribe.....	265
5.18.3	MID 0211 Status externally monitored inputs	266
5.18.4	MID 0212 Status externally monitored inputs acknowledge	266
5.18.5	MID 0213 Status externally monitored inputs unsubscribe.....	266
5.18.6	MID 0214 IO device status request	267
5.18.7	MID 0215 IO device status reply	267
5.18.8	MID 0216 Relay function subscribe.....	279
5.18.9	MID 0217 Relay function	280
5.18.10	MID 0218 Relay function acknowledge	280
5.18.11	MID 0219 Relay function unsubscribe	281
5.18.12	MID 0220 Digital input function subscribe	281
5.18.13	MID 0221 Digital input function.....	281
5.18.14	MID 0222 Digital input function acknowledge.....	283
5.18.15	MID 0223 Digital input function unsubscribe	283

5.18.16	MID 0224 Set digital input function.....	284
5.18.17	MID 0225 Reset digital input function.....	284
5.19	Application PLC user data messages	285
5.19.1	MID 0240 User data download.....	286
5.19.2	MID 0241 User data subscribe.....	287
5.19.3	MID 0242 User data	287
5.19.4	MID 0243 User data acknowledge	288
5.19.5	MID 0244 User data unsubscribe	288
5.19.6	MID 0245 User data download with offset.....	288
5.20	Application Selector messages	290
5.20.1	MID 0250 Selector socket info subscribe	290
5.20.2	MID 0251 Selector socket info.....	290
5.20.3	MID 0252 Selector socket info acknowledge.....	290
5.20.4	MID 0253 Selector socket info unsubscribe	291
5.20.5	MID 0254 Selector control green lights	291
5.20.6	MID 0255 Selector control red lights	292
5.20.7	MID 1900 Selector socket info.....	293
5.20.8	MID 1901 Selector socket control.....	295
5.21	Application Tool Location System messages	297
5.21.1	MID 0260 Tool tag ID request	297
5.21.2	MID 0261 Tool tag ID subscribe	297
5.21.3	MID 0262 Tool tag ID	297
5.21.4	MID 0263 Tool tag ID acknowledge	298
5.21.5	MID 0264 Tool tag ID unsubscribe	298
5.21.6	MID 0265 External Tool tag ID and status.....	299
5.22	Application Controller messages.....	300
5.22.1	MID 0270 Controller reboot request	300
5.22.2	MID 2100 Device command.	301
5.23	Statistic messages	303
5.23.1	MID 0300 Histogram upload request	303
5.23.2	MID 0301 Histogram upload reply	303
5.24	Application Automatic/Manual mode messages.....	306
5.24.1	MID 0400 Automatic/Manual mode subscribe	306
5.24.2	MID 0401 Automatic/Manual mode	306
5.24.3	MID 0402 Automatic/Manual mode acknowledge	306
5.24.4	MID 0403 Automatic/Manual mode unsubscribe	307
5.24.5	MID 0410 AutoDisable settings request	307
5.24.6	MID 0411 AutoDisable settings reply	307
5.25	Application Open Protocol Commands Disabled.....	309
5.25.1	MID 0420 Open Protocol commands disabled subscribe.....	309
5.25.2	MID 0421 Open Protocol commands disabled	309
5.25.3	MID 0422 Open Protocol commands disabled acknowledge	310
5.25.4	MID 0423 Open Protocol commands disabled unsubscribe.....	310
5.26	Application MID 8000 to MID 8100 and MID 9000 to 9100	311
5.27	Application Motor tuning.....	311
5.27.1	MID 0500 Motor tuning result data subscribe	311
5.27.2	MID 0501 Motor tuning result data	311
5.27.3	MID 0502 Motor tuning result data acknowledge	311
5.27.4	MID 0503 Motor tuning result data unsubscribe	312
5.27.5	MID 0504 Motor tuning request.....	312
5.28	Application Keep alive message	313
5.28.1	MID 9999 Keep alive message.....	313
6	Unit /Parameter ID/Data Type definitions.....	314
6.1	Data Type definitions.....	314
6.2	Trace Plotting type figures definitions.....	315
6.3	Unit types definitions	315
6.4	Parameter ID numbers	318

- 6.4.1 Tightening error definition 335
- 6.5 Systems Unique Parameter ID number series338
- 7 Appendix.....339**
- 7.1 Message part numbering table339

Figure 1 Open Protocol in the network, example.....	13
Figure 2 Communication structure.....	25
Figure 3 Serial communication protocol	27
Figure 4 Integrator sending serial communication protocol with 3964R handshake	28
Figure 5 Controller sending serial communication protocol with 3964R handshake.....	28
Figure 6 Message example with byte number	30
Figure 7 Message example without byte number	30
Figure 8 Normal communication	42
Figure 9 No Acknowledge received	43
Figure 10 Wrong sequence numbering	44
Figure 11 Transmission broken	45
Figure 12 Ethernet connection example A.....	46
Figure 13 Ethernet connection example B.....	47
Figure 14 Serial connection example	47
Figure 15 Serial connection with 3964R, example.....	48
Figure 16 Starting a subscription	51
Figure 17 Sending a request	52
Figure 18 Send a command	53
Figure 19 Work Order example at parameterized to “Job abortion after all remaining results reported”	56
Figure 20 Production startup Pset selection	58
Figure 21 Running production at Pset selection	59
Figure 22 Production startup at Job selection.....	61
Figure 23 Running production at Job selection.....	62
Figure 24 Histogram example.....	304

Contents

Table 1 Header content	31
Table 2 Message with binary data contents	33
Table 3 Data field content.....	35
Table 4 Variable Data field content.....	37
Table 5 Message end content	38
Table 6 Messages using the variable parameter pattern.....	64
Table 7 Available messages.....	69
Table 8, MID 9998 Rev 1.....	75
Table 9 Error code description.....	75
Table 10, MID 9997 Rev 1.....	76
Table 11 MID 0001 Revision 7	76
Table 12 MID 0001 Additions for revision 8.....	77
Table 13 MID 0002 Revision 1	77
Table 14 MID 0002 Additions for revision 2.....	78
Table 15 MID 0002 Additions for revision 3.....	78
Table 16 MID 0002 Additions for revision 4.....	78
Table 17 MID 0002 Additions for revision 5.....	79
Table 18 MID 0002 Additions for revision 6.....	79
Table 19 MID 0002 Additions for revision 7.....	80
Table 20 MID 0002 Additions for revision 8.....	80
Table 21 MID 0004 Rev 1.....	81
Table 22 MID 0004 Rev 2.....	81
Table 23 Error code description.....	81
Table 24 MID 0005 Rev 1.....	85
Table 25 MID 0006, revision 1.....	86
Table 26 MID 0008, revision 1.....	87
Table 27 MID 0009, revision 1.....	88
Table 28 MID 0011 Rev 1.....	89
Table 29 MID 0011 additions for revision 2	89
Table 30 MID 0011 additions for revision 3	90
Table 31 MID 0011 additions for revision 4	90
Table 32 MID 0012 Rev 1, Rev 2 and Rev 5.....	90
Table 33 MID 0012 Rev 3 and Rev 4	90
Table 34 MID 0013 Revision 1	91
Table 35 MID 0013 additions for revision 2	92
Table 36 MID 0013 Revision 3 and 4	92
Table 37 MID 0013 Revision 5, Continuation of revision 2	92
Table 38 MID 0015 Revision 1	93
Table 39 MID 0015 Revision 2	93
Table 40 MID 0018 Revision 1	95
Table 41 MID 2504 Revision 1	96
Table 42 MID 0019 Revision 1	97
Table 43 MID 0019 Revision 2	97
Table 44 MID 0020 Revision 1	98
Table 45 MID 0022 Revision 1	99
Table 46 Node specification revision 1	103
Table 47 Node specification for revision 2.....	104
Table 48 Node specification for revision 3.....	105
Table 49 Available node types.....	106
Table 50 Example parameters for PF4000.....	106
Table 51 Example parameters for PM4000.....	109
Table 52 MID 2501 Request extra data.....	111
Table 53 MID 2501 Subscription extra data	111
Table 54 Definition of required parameters for MID 2506.....	112
Table 55 MID 2601 Mode ID upload reply, revision 1.....	115
Table 56 MID 2602 Mode data upload request, revision 1	115
Table 57 MID 2603 Mode data upload reply, revision 1	116
Table 58 MID 2604, revision 1.....	116
Table 59 MID 2606 data, revision 1.....	117
Table 60 MID 0031 Revision 1	118
Table 61 MID 0031 Revision 2	118
Table 62 MID 0032 Revision 1	119

Table 63 MID 0032 Revision 2, 3 and 4	119
Table 64 MID 0033 Job data Revision 1	120
Table 65 MID 0033 Job data Revision 2.....	121
Table 66 MID 0033 Job data Revision 3.....	123
Table 67 MID 0033 Job data Revision 4.....	123
Table 68 MID 0033 Job data Revision 5.....	124
Table 69 MID 0035 Job info Revision 1	125
Table 70 MID 0035 Job info Revision 2.....	126
Table 71 MID 0035 Job info Revision 3.....	127
Table 72 MID 0035 Job info Revision 4.....	127
Table 73 MID 0035 Job info Revision 5.....	128
Table 74 MID 0038 Job ID, revision 1	130
Table 75 MID 0038 Job ID, revision 2	130
Table 76 MID 0039 Revision 1	131
Table 77 MID 0039 Revision 2	131
Table 78 MID 0040 Tool data upload request revision 6 -7, no data for revision 0-5.....	132
Table 79 MID 0041 Tool data, revision 1	132
Table 80 MID 0041 Tool data, additions for revision 2	133
Table 81 MID 0041 Tool data, additions for revision 3	133
Table 82 MID 0041 Tool data, additions for revision 4	134
Table 83 MID 0041 Tool data, additions for revision 5	134
Table 84 MID 0041 Tool data, additions for revision 6	134
Table 85 MID 0041 Tool data, additions for revision 7	134
Table 86 MID 0042 Disable tool, additions for revision 2, no data in revision 0-1.....	136
Table 87 MID 0043 Enable tool, additions for revision 2, no data in revision 0-1	137
Table 88 MID 0045 Set calibration value request revision 1.....	138
Table 89 MID 0045 Set calibration value request, additions for revision 2	138
Table 90 MID 0045 Set calibration value request, additions for revision 3	138
Table 91 MID 0046 Primary tool, revision 000-001.....	139
Table 92 MID 0047 Tool Pairing handling, revision 000-001	139
Table 93 MID 0048 Tool Pairing status Revision 000-001.....	140
Table 94 MID 0700 Data	141
Table 95 MID 0701 Tool list upload reply revision 1	141
Table 96 MID 0702 Request extra data.....	142
Table 97 MID 0702 Data	142
Table 98 Examples of tool parameters PIDs that can be included as variable parameter:	142
Table 99 MID 703 Data	143
Table 100 Examples of tool parameter PIDs that can be included as variable parameter:.....	143
Table 101 Examples of tool parameters PIDs that can be included as variable parameter:.....	144
Table 102 MID 0704 Request extra data.....	144
Table 103 MID 0704 Subscription extra data	145
Table 104 MID 0704 Unsubscription extra data.....	145
Table 105 MID 0050 Revision 1	146
Table 106 MID 0052 Identifier data, revision 1	147
Table 107 MID 0052 Identifier data, additions for revision 2.....	147
Table 108 MID 0061 Revision 1	150
Table 109 MID 0061 Revision 2	152
Table 110 MID 0061 Revision 3	157
Table 111 MID 0061 Revision 4	157
Table 112 MID 0061 Revision 5	157
Table 113 MID 0061 Revision 6	158
Table 114 MID 0061 Revision 7	158
Table 115 MID 0061 Revision 8	158
Table 116 MID 0061 Revision 9	159
Table 117 MID 0061 Revision 10	159
Table 118 MID 0061 Revision 11	161
Table 119 MID 0061 Revision 998	162
Table 120 MID 0061 Light, revision 999.....	162
Table 121 MID 0064 Revision 1	164
Table 122 MID 0064 Revision 10	164
Table 123 MID 0065 Revision 1	165
Table 124 MID 0065 Revision 2	166

Contents

Table 125 MID 0065 Revision 3	169
Table 126 MID 0065 Revision 4	169
Table 127 MID 0065 Revision 5	170
Table 128 MID 0065 Revision 6	170
Table 129 MID 0065 Revision 7	171
Table 130 MID 0065 Revision 8	171
Table 131 MID 0065 Revision 9	171
Table 132 MID 0065 Revision 10	172
Table 133 MID 0065 Revision 11	173
Table 134 MID 0065 Revision 998	173
Table 135 MID 0066 Revision 1	175
Table 136 MID 0066 Revision 2	175
Table 137 MID 0067 Request extra data	176
Table 138 MID 0067 Tightening Result List Upload	176
Table 139 MID 900 Data field, revision 1	177
Table 140 MID 900 Data field, revision 2	179
Table 141 MID 900 Data field, revision 3	181
Table 142 MID 900 Request extra data	183
Table 143 Extra data field for subscription MID 900, revision 1	184
Table 144 Extra data field for unsubscription MID 900, revision 1	187
Table 145 MID 901 Request extra data	188
Table 146 MID 901 data field, revision 1	188
Table 147 MID 901 data field, revision 2	189
Table 148 MID 901 data field, revision 3	190
Table 149 MID 0902 Data field, revision 1	192
Table 150 MID 1201 Request extra data	194
Table 151 MID 1201, Subscription "Extra data" field included in MID 0008, rev 001	194
Table 152 MID 1201 Data, revision 1	196
Table 153 MID 1201 Data, revision 2	197
Table 154 MID 1201 Data, revision 3	198
Table 155 MID 1202, revision 1	199
Table 156 MID 1202, revision 2	200
Table 157 MID 0071 Alarm data revision 0-1	206
Table 158 MID 0071 Alarm data revision 2	207
Table 159 MID 0071 Alarm data revision 3	207
Table 160 MID 0074 Alarm acknowledged revision 1	209
Table 161 MID 0074 Alarm acknowledged revision 2	209
Table 162 MID 0076 Alarm status data Rev 1	210
Table 163 MID 0076 Alarm status data Rev 2	210
Table 164 MID 0076 Alarm status data Rev 3	210
Table 165 MID 1000 Alarm data	211
Table 166 MID 1000 Alarm data typical PIDs revision 1	212
Table 167 MID 0081 Revision 1	213
Table 168 MID 0082 Revision 1	213
Table 169 MID 0091 Multi-spindle status data	214
Table 170 MID 0100 Revision 2	216
Table 171 MID 0100 Revision 3, 4, 5 and 6	216
Table 172 MID 0101 Multi-spindle result data, Revision 1, 2 and 3	217
Table 173 MID 0101 Multi-spindle result data, Revision 4	220
Table 174 MID 0101 Multi-spindle result data, Revision 5	222
Table 175 MID 0101 Multi-spindle result data, Revision 6	222
Table 176 MID 0104 Revision 1 to 6	225
Table 177 MID 0105 Revision 2, 3 and 4	227
Table 178 MID 0106 Last tightening result Station data, revision 1,2 and 3	227
Table 179 MID 0106 Last tightening result Station data, revision 4	230
Table 180 MID 0107 Last tightening result Bolt data, revision 1, 2 and 3	234
Table 181 MID 0107 Last tightening result Bolt data, revision 4	237
Table 182 MID 0108 Revision 1-4	241
Table 183 MID 0110 Revision 1	242
Table 184 MID 0110 Graphic text display	243
Table 185 MID 0129 Revision 2	246
Table 186 MID 0130 Revision 1	246

Table 187 MID 0140 Dynamic Job data revision 1	248
Table 188 MID 0140 Dynamic Job data revision 2	249
Table 189 MID 0140 Dynamic Job data revision 3	250
Table 190 MID 0140 Dynamic Job data revision 4	253
Table 191 MID 0140 Dynamic Job data revision 999	256
Table 192 MID 0150 Revision 1	257
Table 193 MID 0152 Multiple identifier and result parts data, Revision 1	258
Table 194 MID 1601 Subscription extra data	260
Table 195 MID 1601 Data field, revision 1	261
Table 196 MID 1601 Suggested PIDs to support	261
Table 197 MID 0200 Relay status revision 1	264
Table 198 MID 0211 Digital input status revision 1	266
Table 199 MID 0214 Revision 1 and 2	267
Table 200 MID 0215 Revision 1	268
Table 201 MID 0215 Revision 2	268
Table 202 MID 0215 Relay number	269
Table 203 MID 0215 DigIn number	275
Table 204 MID 0216 Revision 1	279
Table 205 MID 0217 Relay no and status Revision 1	280
Table 206 MID 0219 Revision 1	281
Table 207 MID 0220 Revision 1	281
Table 208 MID 0221 Digital input no and status Revision 1	282
Table 209 MID 0223 Revision 1	283
Table 210 MID 0224 Revision 1	284
Table 211 MID 0225 Revision 1	284
Table 212 Example 1 input	285
Table 213 Example 1 output	285
Table 214 MID 0240 Revision 1	286
Table 215 MID 0242 Revision 1	287
Table 216 MID 0245 User data download with offset, revision 1	289
Table 217 MID 0251 Selector socket data Revision 1	290
Table 218 MID 0254 Selector green lights revision 0, 1	291
Table 219 MID 0254 Selector green lights revision 2	292
Table 220 MID 0255 Selector red lights revision 0, 1	292
Table 221 MID 0255 Selector red lights revision 2	293
Table 222 MID 0262 TLS ST Tool Tag Identity Revision 1	297
Table 223 MID 0265 External TLS Tool Tag Identity and status Revision 1	299
Table 224 Definition of required and optional parameters of MID 2100	301
Table 225 Available Generic Commands	302
Table 226 MID 0300 Parameter set and histogram type Revision 1	303
Table 227 MID 0301 Histogram data Revision 1	304
Table 228 MID 0401 Revision 1	306
Table 229 MID 0411 Revision 1	308
Table 230 MID 0421 Revision 1	309
Table 231 MID 501 Motor tuning result data Revision 1	311
Table 232 Data type definitions	314
Table 233 Unit type definitions	315
Table 234 Parameter IDs definitions common	318
Table 235 Tool Information PID list	335
Table 236 Example of definitions for tightening error codes	336
Table 237 Parameter IDs definitions system unique	338

1 Introduction

Open Protocol is an interface for building applications for remote control or data subscription of controllers. It is platform independent and can be implemented on Linux, PLC, printers, and all Windows platforms for example.

The Open Protocol supports both serial and Ethernet connection.

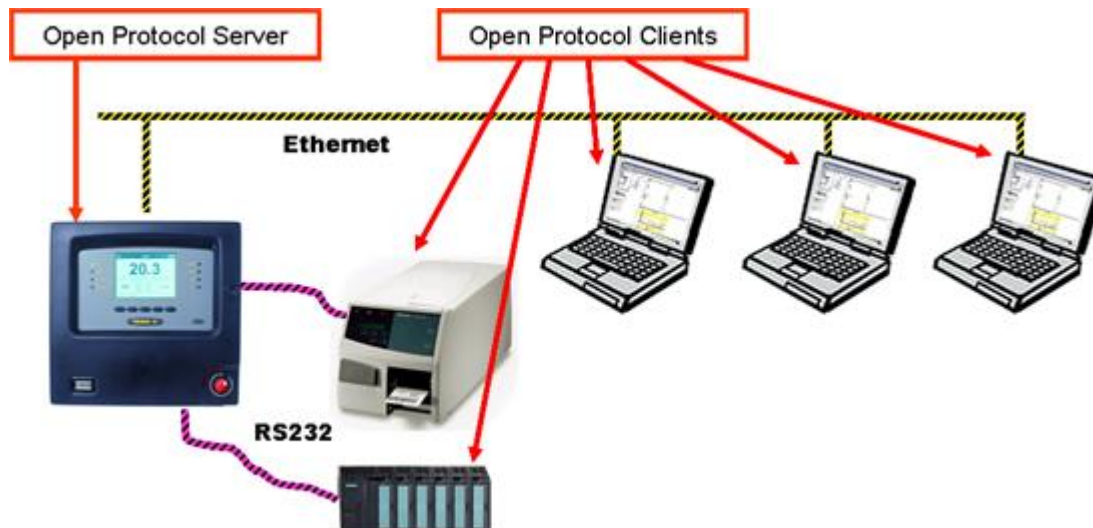

Figure 1 Open Protocol in the network, example

1.1 Revision history

The changes since release 1.2 revision 14 are:

Version	Date	Author	Change
2.0	2014-03-20	Björn Johansson	New MIDs 02500 and 02501 added Program upload and download. Revision upgraded due to all the new protocol basic functionality added also in 1.6.5
2.1	2014-05-20	Björn Johansson	Corrections done of PID numbers 01001-01033
2.2	2014-06-22	Björn Johansson	Added MID 2505 for Pset dynamic selection. Added PIDs 00030-00031. Added new PIDs 02215, 02216, 02217 and 02218 for 4 stage tightening, used in MID 900.
2.3	2015-03-30	Björn Johansson	Added MID 700 for Tightening data download status for radio connected Tools. Added new PIDs 04000-04002 for that purpose. Also more specification text for clarifying of the Tool pairing functionality with MID 0047, 0048

Version	Date	Author	Change
2.4	2015-05-19	Björn Johansson	Added Digin functions 136 and 137
2.5	2015-06-16	Björn Johansson	Change the subscription extra data for results supporting historical data
2.6	2015-09-21	Björn Johansson	<p>1. Clarification of generic subscription answers/acknowledging</p> <p>2. Correction of MID 61 Rev. 7 length. Jira issue OPC 38</p> <p>3. Subscriptions on Results Mid 1201 and 1202 and Traces MID 900 and 901 possible to get as snap time, snap Id, latest and from Id or Time to latest. Added PIDs 00050-00053 for that purpose. MID 0071 added with Error text in revision 2 Added PIDS for tuning. Added subscription for Pset upload at change.</p>
2.7	2016-02-02	Björn Johansson	<p>Added controller information in Revision 6 of MID 0002 about Station Id and Station Name for PF 6000. Used by PF 4000 for Cell Id and Cell Name.</p> <p>Also added a Client Id.</p> <p>Added new revision 2 for MIDs 0254, 0255 Selector Control.</p> <p>Added spec., for MID 1900 and MID 1901 which use the variable pattern and shall substitute the use of MID 0254, 0255 and belonging subscription and stop subscription and acknowledging by using the generic MID 0008, MID 0009 subscription, stop subscription.</p> <p>Added PIDs 01508, 01509 for Job reference Mac and Job start time.</p> <p>Corrected MID 900 description by adding PID 02214 coefficient for multiplication of the 16 bit trace values as alternative to PID 02213</p> <p>Added a chapter for Session control functionality</p>
2.7.1	20160601	Björn Johansson	Corrections made after review
2.8.0	20170201	John-Eric Ericsson	<p>Added revision 5 of MID 0035</p> <p>Removed all header definitions for all MIDs and refer to the specification in its own section</p> <p>Added revision 5 of MID 0101</p> <p>Added MID 2100, Device command</p> <p>Added information that Relay function and DigIN function lists can be overridden by device specific appendix</p> <p>Removed the need of E before alarm codes in MID 0071 and 0076</p>

Version	Date	Author	Change
2.9.0	20180808	John-Eric Ericsson	<p>Added MID 0701 Tool list upload reply Added MID 1000 Alarm Added MID 1001 Alarm acknowledge Added MID 1601 Dynamic identifier message Added MID 1602 Dynamic identifier data ack Added PIDs 00005, 00060, 01042, 01205, 01420, 01421, 01422, 01700,01701, 02161-02167, 02170, 05003, 05004, 05160-05173 Added revision 7 of MID 0001 Added revision 7 of MID 0002 Added revision 6 of MID 0040 Added revision 6 of MID 0041 Added revision 2 of MID 0042 Added revision 2 of MID 0043 Added revision 2 of MID 0045 Added revision 3 of MID 0071 Added revision 2 of MID 0074 Added revision 3 of MID 0076 NB! MID 0071 revision 2 change in layout! Due to correction NB! MID 2601 change of layout! NB! MID 2603 change of layout! Relay no. 17 added Dig In no 138-140 added Unit kPa and mNm added Change in PID 01002, 05000 MID 0106 and MID 0107 added clarification to special values Added new batch status in MID 0061 and 0065 Batch reset and Job restart status added in MID 0061, 0065, 0035 and PID 01039 Corrected misspelling Added new tool types to MID 0041 and PID 01203 Changed definition of Controller Changed how command accept for MID 0008 and 0009 shall work MID 0108 removed from list in section 3.9.2 Table 143 Extra data field for subscription MID 900, revision 1 corrected MID 0091 param 04 and 05 corrected</p>
2.10.0	20190222	Spoorthy Surendra	<ol style="list-style-type: none"> 1. Added MID 0702, Tool data upload reply with generic data 2. Added new PID : 01213-Tool temperature

Version	Date	Author	Change
			<ol style="list-style-type: none"> 3. Added MID 0703, Set calibration value request with generic data 4. Changed MID 0045 revision 1, to match the units in MID 0061 5. Added new PID 00105, Batch Status 6. % for Torque unit marked as OBSOLETE 7. MID 0041 and PID 01203 updated with tools types, BCV-RE, BCP-RE, E-LIT 8. Added new MID 0066 Number of offline results 9. Updated MID 0061 and MID 0065 with revision 8 10. Added Reserved revision 999 for MID 64 for BCP-RE and BCP-RE tools 11. Added new PID 01043 Disable loosening 12. Command Id range 1501-2000 reserved for Desoutter 13. Added new PID 02171 Turns for rundown 14. Terminology changes, changed CCS to MES, and 'Siemens 3964R' to PLC, which is more generic. 15. Updated MID 0140 with revision 2 16. Updated MID 0032 , to use value 0000 for the Job ID , for current job executed on the fly. 17. Updated MID 0033 with revision 4 18. Updated MID 0040, MID 0041 with revision 7
2.10.1	20190401	Spoorthy Surendra	<ol style="list-style-type: none"> 1. Updated MID 0032 with revision 4 2. Added new PIDs: 01214 – Service Interval 01702 – Maintenance alert 3. Updated PID 01211 with possible values 1 = reset tightening since last service 0 = to do nothing
2.11.0	20190614	Spoorthy Surendra	<ol style="list-style-type: none"> 1. Updated MID 2500 with revision 2 2. Added new MID 0067 , Tightening Result List Upload 3. Updated MID 1201 with Extra data 4. Updated MID 1201 with revision 2 5. Updated MID 900 with Extra data 6. Updated MID 900 with revision 2 7. Updated MID 901 with Extra data 8. Updated MID 901 with revision 2

Version	Date	Author	Change
			9. Updated MID 0005
2.11.1	20190628	Spoorthy Surendra	1. Added node type for multistep tightening program
2.12.0	20190829	Spoorthy Surendra	1. Typo correction for MID 0003 2. Added new PID range
2.13.0	20191219	Spoorthy Surendra	1. MID 0041 and PID 01203 updated with new tool types 2. Updated MID 0061 and MID 0065 with revision 9 3. Added new relay numbers- 354,355 for MID 0215 4. Correction - Byte info for the MID 0071 Rev3 5. Correction- Comments for Unit 161, 162 6. Added new Torque unit-kgf.cm 7. Updated MID 0140 with revision 3
2.14.0	20200625	Spoorthy Surendra	1. Added 2 new Torque units - gf.cm, ft.ozf 2. Added new relay numbers- 356,357,358,359,360,361,362,363,364,365 with descriptions for MID 0215 3. Updated MID 9999 with more information like ,when increased communication timeout value is required by any product 4. Kfcnm torque unit marked as OBSOLETE 5. Correction, required on specification only as MID 0040 is request and cannot include reply data- MID 0040 revision 7 6. Added revision 4 for MID 0011 7. Added revision 5 for MID 0012 and MID 0013 8. MID 0041 and PID 01203 updated with new tool types 9. Updated MID 1601, with information on when the MID 1601 data can be published
2.15.0	20210303	Roland Brändström	1. MID0066 revision 1 updated to match implementation. 2. MID0101 revision 4 updated to match implementation allowing also negative angle values. 3. Minor clarification of static data field use, section 2.3 table 3. 4. Added revision 10 for MID 0064. 5. Added revision 10 for MID 0061 6. Added revision 10 for MID 0065

Version	Date	Author	Change
2.16.0	20220117	Roland Brändström	<p>7. Added retransmission rules chapter</p> <ol style="list-style-type: none"> 1. Corrected MID 0006 or MID 0007 to MID 9997 or MID 9998 where MIDs were mixed up. Removed MID 0007 from table. 2. Added revision 2 for MID 0019. 3. Added revision 5 for MID 0033 and corrected typo errors for revisions 3 and 4. 4. Added revision 4 for MID 0140. 5. Added possibility for controller to initiate TCP connection and possibility to use SSL/TLS. 6. Added best practice to identify a resource conflict. 7. Added revision 2 for MID 0066. 8. Fixed typo errors for MID 0035, revisions 2 and 4. 9. Added revision 3 for MID 1201. 10. Added revision 2 for MID 1202. 11. Added revision 3 for MID 0900. 12. Added revision 3 for MID 0901. 13. MID 0041 and PID 01203 updated with tool type XPBM. 14. Corrected typo error for “Error status 2” in MID 0065.
2.17.0	20230522	Roland Brändström	<ol style="list-style-type: none"> 1. Editorial update 2. New MID 0902 3. Added recommendation to close socket after receiving MID 0003 4. Corrected an old mistake in MID 0019 revision 1 5. New MID 0704 6. New MID 2506 7. Added revision 2 for MID 0004 8. New PIDs 9. Added revision 6 for MID 0101 10. Added note for MID 0015 11. Added revision 11 for MID 0061 12. Added revision 11 for MID 0064 13. New MID 0104
2.18.0	20240528	Roland Brändström	<ol style="list-style-type: none"> 1. Added revision 3 for MID 2500 2. Extended message linking capacity 3. Added revision 998 for MID 0065 4. Added ExBC and ExD tool types in MID 0041 and PID 1203

Version	Date	Author	Change
			<ol style="list-style-type: none">5. Added revision 8 for MID 0001 and MID 00026. Added revision 3 for MID 00457. New PIDs 05174 and 05175
2.19.0	20240930	Andrew Cheese	<ol style="list-style-type: none">1. Added information for MicroTorque Controller Open Protocol Specification to section 1.22. Added PIDs 2033, 2034, 2035, 2045, 2046, 2047
2.20.0	20241028	Andrew Cheese	<ol style="list-style-type: none">1. Updated MID 0015 with revision 32. Updated MID 0035 with revision 63. Updated MID 0061 with revision 124. Updated MID 0065 with revision 125. Added PIDs 00041, 01219, 01220
2.20.1	20041029	Andrew Cheese	<ol style="list-style-type: none">1. Corrections to MID 0065 revision 998

1.2 Referenced documents

The following references are each products implementation specification of the Open Protocol.

Document name
OpenProtocol_PF4000_Specification
OpenProtocol_PF6000_Specification
OpenProtocol_Power MACS_Specification
Open Protocol MT Focus 6000, Printed Matter No. 9839 0732 01 (ServAid)

1.3 Protocol and Specification Versioning

Following rules for Protocol and Specification Version, Release and Revision rules handling are stated.

Example: 1.2.3.

The 1 is the **Version** of the protocol. No compatibility exists between Versions and that means that major changes has been done in the common communication procedures such as acknowledging, startup, patterns, headings etc.

Example was when the protocol went from 1.x.x to 2.0.0. See chapter 3.9.

The 2 is the **Release** of the protocol. On release level the protocol must be backward compatible according to the rules of 1.x type of Versions new **MID Revisions** built on earlier **MID Revisions**.

A new **Release** must hence be backward compatible on the 1.x type Versions using the static variable pattern **MID Revision** and **MID level**. A new **MID** or a new **MID Revision** created, due to new functionality being introduced, increase the figure of the **Release** of the protocol.

Also when adding's of new MIDs using the variable pattern PIDs or adding new PIDs to an existing 2.x MID it will be a new **Release**. At using the variable 2.x patterns for data fields we have an built in backward compatibility due to the nature of PIDs.

The 3 is the **Revision** of the protocol. The Revision is increased due to corrections done in existing 1.x types of MIDs and MIDs revisions or 2.x types MIDs and PIDs. These corrections must NOT have influences on the backward compatibility.

1.4 Terminology

The following terminology is used in this manual.

Term	Definition
Controller	A tightening system, or other Open Protocol enabled device acting as the Open Protocol server. See device specific documentation for which Open Protocol version it supports.
Integrator	Integrator hardware can for example be a PC, PLC, or printer. Integrator applications use the Open Protocol in the integrator HW.
Message	A message consists of three parts; header, data field and message end, as described in section Message structure. Depending on type of communication, a package sent or received includes the message and an encapsulation before and after the message, as described in section Communication.
MID	Message ID of the message represented by four digits, for example 0052. MID 0052 refers to Vehicle ID Number upload. The ID is always included in the message.
MID revision	<p>A MID can have several revisions. If no revision is set, revision 1 is applied. A MID is usually revised to include more data, thus increasing the length of the message. MID revisions are added to ensure backwards compatibility.</p> <p>See for example MID 0052 where revision 2 includes identifier result parts 2, 3 and 4 to the data. If revision 1 is used, this data is not sent. If revision 2 is used and the controller does not support more than one identifier = revision 1, then only the VIN-number is sent in revision 1.</p> <p>Implementation rule for revisions is that there should not allowed to have revision gaps. In other words, the supported revisions SHOULD NOT look like this:</p> <p>MIDxx/rev1, rev2, rev5 or MIDxx/rev5 only.</p> <p>If supporting MIDxx/rev5 the implementation should for instance support an request or subscription on MIDxx/rev 2 and reply with that revision as well. Especially important to remember at new implementation of the Open Protocol in new products.</p>
Subscribe	Subscribe is the term used when the controller sends specific data to the subscriber or subscribers each time it is generated.
Unsubscribe	Unsubscribe is the term used when a subscription is cancelled by the subscriber. The data will no longer be sent from the controller.
PSET	A set of parameters for the tool tightening.

MES Manufacturing Execution System. A customer system on the integrator side that use and rules the controller for the production.

2 Using Open Protocol

This section describes the communication structure between the integrator HW and the controller.

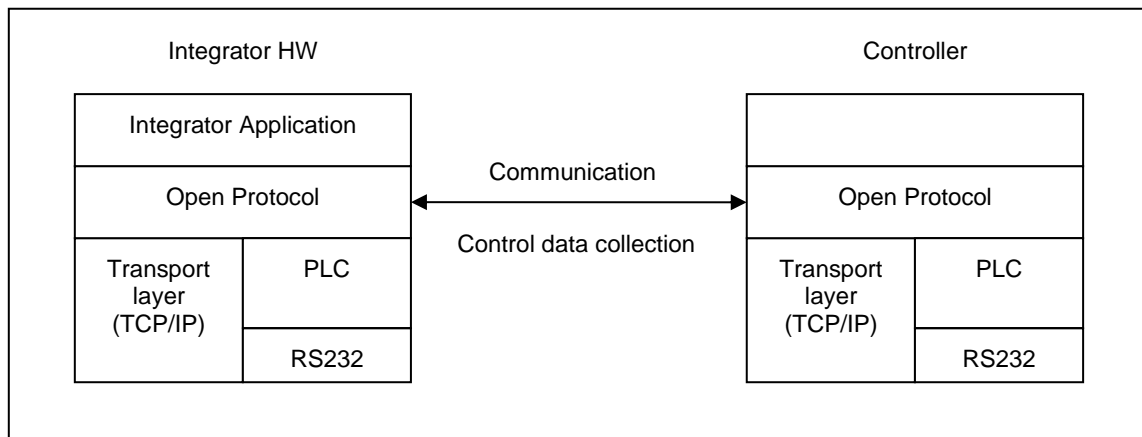

Figure 2 Communication structure

2.1 Communication

The Open Protocol can be run using Ethernet or serial communication. The Open Protocol is a full duplex protocol, which means that data can be sent and received at the same time. Every communication partner must be able to operate a send and receive facility simultaneously.

How support of Ethernet or/and serial communication is available or not is described in the controller specific implementation document.

When using Ethernet, Open Protocol is a pure application protocol, i.e. OSI layer 5-7.

2.1.1 Transport protocol

The transport protocol is only briefly mentioned here, for details see controller specific documentation or other sources.

There are two scenarios for connecting the integrator and the controller:

- A) The integrator initiates a TCP connection to the controller, and the controller accepts the TCP connection. The default port used for the communication is 4545.
- B) The controller initiates a TCP connection to the integrator, and the integrator accepts the TCP connection.

Regardless of the way the TCP connection is established, from the viewpoint of the Open Protocol, the controller is the server, and the integrator application is the client, and all messages sent over Open Protocol work the same way.

Note! The TCP connection may be set up using SSL/TLS protocol.

Note! Ensure that the port is correctly configured in the controller!

Check controller specific documentation for details regarding setting up TCP connections.

It is recommended to close the transport layer connection, i.e. socket, when the OP session is closed by MID 0003.

2.1.2 Serial protocol

There are two kinds of serial protocol.

- Serial ASCII protocol
- Serial ASCII protocol with 3964R handshake

Note! Ensure that the serial port is correctly configured according to the corresponding serial protocol used!

When running serial communication, the messages are encapsulated according to the protocol used. The messages within the encapsulation are the same regardless of type of communication.

Figure 3 Serial communication protocol, and Figure 5 Controller sending serial communication protocol with 3964R handshake, show the encapsulation requirements that must be fulfilled when using serial communication.

2.1.2.1 Serial ASCII protocol

All messages sent from the integrator to the controller must be stamped with a 4 ASCII character tag before the STX character: BEL (ASCII 0x07 bell) HT (ASCII 0x09 horizontal tab) BEL (ASCII 0x07) HT (ASCII 0x09). All messages must be encapsulated between STX (ASCII 0x02 Start of Text) and ETX (ASCII 0x03 End of Text).

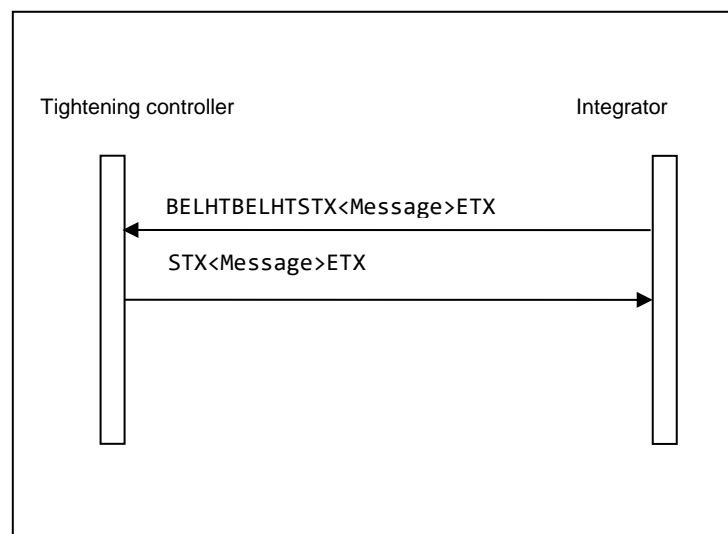

Figure 3 Serial communication protocol

2.1.2.2 Serial ASCII protocol with 3964 R handshake

All messages exchanged between the controller and the integrator are transferred within the message frame in accordance with Siemens Procedure 3964R.

The Procedure 3964R is a transfer protocol between two systems A and B. Every time one of the systems wants to send, the following procedure is initiated.

- request from A to B for data interchange
- data interchange
- end of data interchange

The protocol 3964R allows reliable data as the receiver must first signal to the transmitter that it is ready to receive (communication setup) and then after data interchange must acknowledge correct reception. Data integrity is ensured by an additional block check character (BCC).

The block check control is the XOR sum of all the transmitted data bytes. The generation begins with the first byte of the message and ends after characters DLE (ASCII 0x10 Data Link Escape) and ETX (ASCII 0x03 End of Text).

The description is valid for both cases, when the integrator is the sender and the controller the receiver, and the opposite. See Figure 4 and Figure 5 Controller sending serial communication protocol with 3964R handshake.

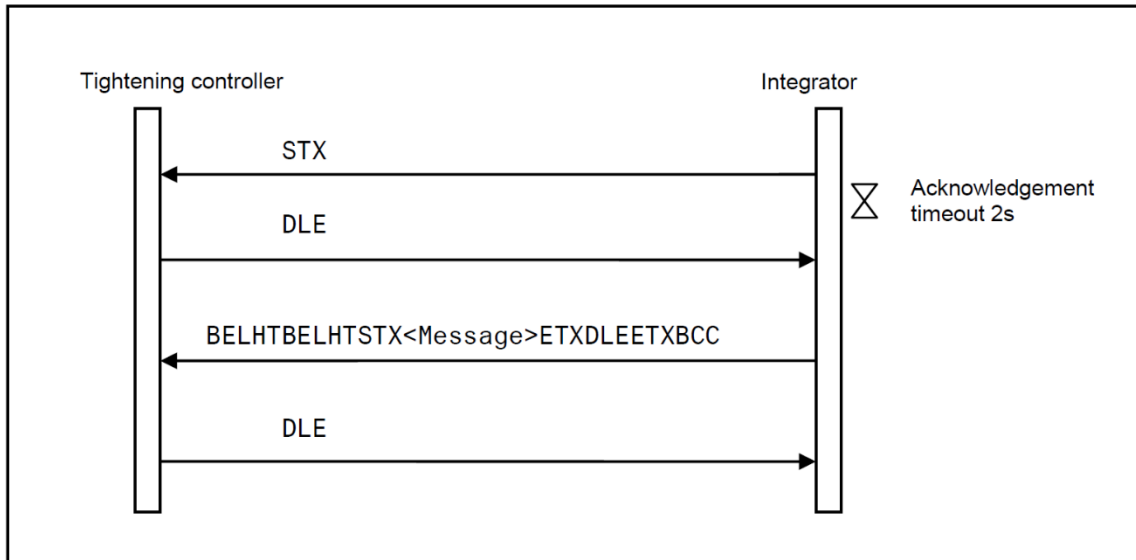

Figure 4 Integrator sending serial communication protocol with 3964R handshake

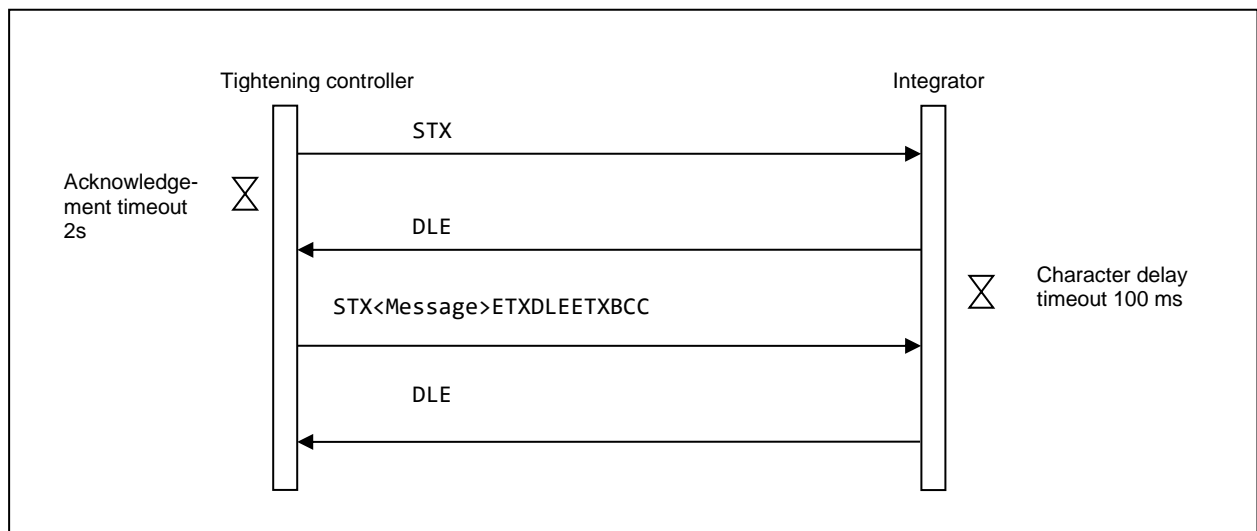

Figure 5 Controller sending serial communication protocol with 3964R handshake

The following steps are included when the controller is sending to the integrator.

The controller sends the control character STX (ASCII 0x02 start of text) and waits for an acknowledgment for 2s (acknowledgment timeout = 2s).

The integrator responds with the acknowledge character DLE (ASCII 0x10 data link escape) and the Controller reverts to transmit mode.

If the integrator responds with control character NAK (ASCII 0x15 Negative acknowledgment) or any other control character (apart from DLE) or if the acknowledgment delay time elapses, the connection setup procedure has failed. The connection setup procedure is aborted after a total of 6 unsuccessful attempts.

The Controller sends an Open Protocol serial message followed by the characters ETX, DLE, ETX and BCC as end identifier. The controller then waits for an acknowledgement character from the integrator.

The integrator monitors the incoming time between two characters. The interval between two characters may not exceed the character delay timeout =100 ms.

The integrator sends the control character DLE and the Open Protocol message has been accepted error free.

If the integrator responds with control character NAK (ASCII 0x15 Negative acknowledgment) or any other character (apart from DLE) or if the acknowledgment delay time elapses with no answer, then the transmission is aborted and the controller starts a new connection setup with character STX. The procedure is aborted and the controller sends a NAK to the integrator after a total of six unsuccessful attempts.

The following is also applicable:

If the integrator sends a NAK during transmission, then the controller aborts the transmission and repeats it in the manner described above. In the case of any other character the integrator waits for the character delay time to elapse and then sends a NAK.

If the integrator receives an STX from the controller in idle state, it answers with DLE. If it receives any other character than STX in idle state it waits for the character delay time to elapse and then sends a NAK. After each character, the next character is awaited during the character delay time =100ms. If the character delay time elapses without new reception a NAK is sent to the controller.

If the integrator detects the character string DLE ETX BCC, it terminates reception. It then compares the BCC with the internally generated one. If the BCC is correct and no error reception has occurred it sends a DLE to the controller. If the BCC is not correct a NAK is sent to the controller. A retry is then awaited. If it is not possible to receive the message with error free BCC after 6 attempts, the integrator aborts the reception.

2.2 Message structure

Most of the information sent over the communication links is in ASCII format. Some messages can also contain binary data and this is described at each MID.

A message consists of three parts; header, data field and message end. The sections below describe each part in detail.

2.2.1.1 Example

This following example shows **MID 0071 Alarm**.

- Figure 6 shows the number of the byte above the message.
- Figure 7 shows the same message without the numbers but with the spaces shown.

The spaces must be included according to each message structure.

1	2	3	4	5	6	7	8	9	10	11	12	13	14	15	16	17	18	19	20	21	22	23	24	25	26	27	28	29	30	31	32	33	34	35	36	37	38	39	40	41	42	43	44	45	46	47	48	49	50	51	52	53	54		
0	0	5	3	0	0	7	1													0	1	E	4	0	4	0	2	1	0	3	1	0	4	2	0	0	8	-	0	9	-	2	5	:	1	0	:	1	4	:	1	6	N	U	L

Figure 6 Message example with byte number

00530071	01E404021031042008-09-25:10:14:16NUL
----------	--------------------------------------

Figure 7 Message example without byte number

2.2.2 Header

The header contains 20 bytes according to Table 1.

Table 1 Header content

Message part	Byte	Parameter	Value
Header	1-4	Length	<p>The length is the length of the header plus the data field excluding the NUL termination.</p> <p>The header always includes information about the length of the message. The length is represented by four ASCII digits ('0'...'9') specifying a range of 0000 to 9999.</p> <p>When using the message linking functionality the length represents the length of each message part number.</p> <p>When having one ASCII part followed by an binary part the length is the total length of the message.</p>
	5-8	MID	The MID is four bytes long and is specified by four ASCII digits ('0'...'9'). The MID describes how to interpret the message.
	9-11	Revision	<p>The revision of the MID is specified by three ASCII digits ('0'...'9').</p> <p>The MID Revision is unique per MID and is used in case different versions are available for the same MID. Using the revision number the integrator can subscribe or ask for different versions of the same MID. By default the MID revision number is three spaces long.</p> <p>If the initial MID Revision (revision 1) is required there is three different ways to get it, either send three spaces or 000 or 001.</p>
	12	No ack flag	<p>ONLY FOR SUBSCRIPTION MIDs.</p> <p>The No Ack Flag is used when setting a subscription. If the No Ack flag is not set in a subscription it means that the subscriber will acknowledge each "push" message sent by the controller (reliable mode).</p> <p>If set, the controller will only push out the information required without waiting for a receive acknowledgement from the subscriber (unreliable mode).</p> <p>Note! NOT USED WHEN USING SEQUENCE NUMBER HANDLING</p>
	13-14	Station ID	The station the message is addressed to in the case of controller with multi-station configuration. The station ID is 2 byte long and is specified by two ASCII digits ('0'...'9'). Two spaces are considered as station 1 (default value).
	15-16	Spindle ID	The spindle the message is addressed to in the case several spindles are connected to the same controller. The spindle ID is 2 bytes long and is specified by two ASCII digits ('0'...'9'). Two spaces are considered as spindle 1 (default value).
	17-18	Sequence number	<p>From OP Spec. 2.0. 1-99-1. For acknowledging on "Link Level" with MIDs 0997 and 0998.</p> <p>Not used if space or zero and not 1-99.</p> <p>At communication restart MID 0001/MID 0002 it must be set to one and info in MID 0002 is telling if possible to use or not. It is backward compatible and If used it will substitute the No Ack flag and all special subscription data messages ACK MIDs.</p>

	19	Number of message parts	From OP spec. 2.0. Linking function can coded value up to 99 = possible to send 99*9999 bytes messages. ~ 990 kB, see 7.1 for coding table. Used when the message length is overflowing the max length of 9999. Not used if space or zero.
	20	Message part number	From OP spec. 2.0. Linking function for message length > 9999. Coded value for up to 99 linked messages, see 7.1 for coding table. Not used if space or zero
Data field	21	21-Length	See revisions or data patterns for variable data fields
Message end		See Value column	At whole message in ASCII the end = NULL OP Spec. 2.0 At first part of message in ASCII and followed by an binary part, the ASCII part is ended with a NULL character just before the first data of the binary part begins.



The Length and MID are padded on the left with zeroes (ASCII 0x30).

2.2.3 New MID numbers use from OP 2.0

All new MIDs creation has to use the MID numbers groups as defined below. It is divided into data type/function type groups. This is the rule from OP spec. version 2.0 and upwards.

These are the existing groups of MID number series:

Job message MID 600-699

Tool messages MID 700-799

VIN Messages MID 800-899

Tightening result messages MID 900-999

Alarm messages MID 1000-1099

Time messages MID 1100-1199

Multi-spindle status messages MID 1200-1299

Multi-spindle result messages MID 1300-1399

User interface messages MID 1400-1499

Job messages, advanced MID 1500-1599

Multiple identifiers messages MID 1600-1699

I/O Interface MID 1700-1799

PLC user data messages MID 1800-1899

Selector messages MID 1900-1999

Tool Location System messages MID 2000-2099

Controller messages MID 2100-2199

Statistic messages MID 2200-2299

Automatic/Manual mode messages MID 2300-2399

Open Protocol Commands Disabled MID 2400-2499

Parameter Set Messages MID 2500-2599

New groups from MID 2600.

A new MID is hence needed to be specified when a new data type is wanted to be transferred, either in an existing group or within a new group.

2.2.4 MID with both ASCII and binary data from OP 2.0

MID's with binary data has one ASCII data part and one binary data part. The ASCII part is always sent first together with the header and is ended with an NUL character. Thereafter the binary data begins and no NUL character is sent after the binary data.

The Header length is always the TOTAL length of the message , i.e. the length of the ASCII data including the header, the NUL character and all the binary data.

These are the MID's that has binary data in the message

Table 2 Message with binary data contents

MID	Name	Description
0900	MID 0900 Trace curve data message	All Trace sample is sent in binary format

2.2.5 Sequence number functionality from OP spec. 2.0

The sequence number is used in conjunction with MID 9997 and MID 9998 for communication acknowledging on Application **Link Level**. The sequence number is set to 1-99-1 etc.

The sequence number is to be used if the fields are set difference from space or zero and is set to 1-99.

At communication restart with MID 0001/MID 0002 exchange, the sequence number must be initialized to 01 as the first sequence number to use for data transmission and the first sequence number to expect at first data message receiving.

In the MID 0002 information is if it is possible to use it or not. See description on MID 0002.

If used, it will override the No Ack flag and all special subscription data messages ACK MIDs that shall not be used.

The benefits of using sequence numbering and MID 9997 and MID 9998 acknowledging is that a much faster acknowledge of received message can be achieved without application level performance dependency/delays for communication acknowledge.

Furthermore it is possible to recognize retransmissions, avoiding to load the controller with commands, requests or subscriptions that has already been taken care of but not yet been fully performed and acknowledged by the application level with MID 0004, MID 0005 or the direct Request Reply Data.

Using Sequence number functionality means that all messages (Requests, Commands or Subscriptions) will be fast acknowledged on an Application **Link Level** (MID 9997) which also means that the message has been formally checked and correct received.

If not formally correct, the message will be acknowledged with MID 9998 and an error code that tells the receiver about the reason.

If correct received the wanted controller action will be performed on the Application Level and will later result in either a successful action done through MID 0005 message or a direct Request Reply Data message response.

At an unsuccessful action, the response will be an MID 0004 message.

In this case the MID 0004 and MID 0005 shall not be seen upon as acknowledgements anymore but as messages that also shall be acknowledged by MID 9997 or MID 9998.

2.2.6 Message linking functionality from OP spec 2.0

Message linking functionality is used when the message length are more than 9999 bytes. Another reason could be that the equipment using Open Protocol has a reduced possibility to have huge buffers but anyway wants to have the possibly to send huge messages.

A linked message is a message divided into a number of transmissions, where each transmission consists of the Header and a part of the whole message data field.

The break points for next part of the message to be put into a part's data field must be aligned with a parameter data field size.

Next part of a message data field always starts at byte 21 after the header.

Number of Message parts" field can be up to 99 and are used if different from space. Valid values are defined in coding table, see 7.1. This gives the possibility to send 99*9999 bytes messages. ~ 990 kB.

2.3 Static Data Field use

The Static Data Field is ASCII data, representing the data. The data contains a list of parameters depending on the MID. Each parameter is represented with an ID and the parameter value. Note that the ID always is 2 bytes. The data field can be empty or contain a maximum of 9979 bytes.

Table 3 Data field content

Message part	Byte	Parameter	Value
Data field	21-22	01	Parameter ID (00...99), length two bytes. The parameter ID is padded on the left with the ASCII characters '0'.
	23 -	Parameter 01 value	Parameter value is defined by parameter selection (fixed number of bytes). ASCII digits ('0'...'9') or ASCII characters between 0x20 and 0x7F Hex. If the Parameter value is specified only by ASCII digits, then the parameter value is padded on the left with the ASCII characters '0'. If the Parameter value is specified by ASCII characters, then the parameter value is padded on the right with space <SPC> (ASCII character 0x20 Hex). If the Parameter value is not supported or not defined, the whole parameter field is filled with spaces <SPC> (ASCII character 0x20 Hex).
	n-	02	Parameter 02
	n+2-	Parameter 02 value	Parameter 02 value...
		03	Parameter 03
		Parameter 02 value	Parameter 03 value...

2.3.1 Static Data field implementation rules

All the parameters of the data field must be sent.

The data field of each message is subject to future modifications handled by adding MID revisions. A new revision can include new parameters or increased length of the data field.

At implementation of an existing MID with a number of versions all versions must be supported

If the not supported parameters can be determined as never to be supported when trying to use an existing MID, instead a new MID **MUST** be defined with these parameters excluded, which in the long run will give a cleaner interface. To be sent to the Open Protocol committee.

All torque and angle values sent in the data part are sent in units Nm and degrees when nothing else is specified. For degrees one turn represents 360 degrees.

2.4 Variable data field use from OP spec 2.0

Variable data field is a possibility to use a full variable way to send data.

This pattern is substituting all use of the static field implementation rules and revision handling.

The data represented in a variable field pattern can be placed anywhere in the message after the header or not sent at all. Which data that should be sent is a configuration issue in each product.

The Unit Names and Data Type names are defined in product independent global namespaces. New names can be defined in later releases of this document.

For Unit Names, Parameter IDs and Data Types, see chapter 6.

In each MID description they are also described if used.

If used and the use of this pattern is described under each MID description.

Table 4 Variable Data field content

Parameter	Size	Data type	Description			
Number of data fields	3	UI	The number of variable data fields in the telegram. If no data fields exist "000" will be sent. Must be the first of each section of variable data fields.			
Data fields	Vary		This section is repeated Number of data fields times. If Number of data fields = 000, this section is not sent.			
			Parameter	Size [byte]	Data type	Description
			Parameter id (PID).	5	UI	The available PID's may vary depending on the system type.
			Length	3	UI	Length of data value.
			Data Type	2	UI	Data type of the data value.
			Unit	3	UI	Unit of the data.
			Step no.	4	UI	The step number for the result variable. Sent as 0000 if not relevant
			Data value	Length		The data value.

Note! All fields with strings are left adjusted and padded with spaces. All numerical fields are right adjusted and padded with 0's.

2.4.1 Message End

The message end is empty.

Table 5 Message end content

Message part	Byte	Parameter	Value
Message end	1	Message end	<p>If the message is pure ASCII the message is NUL terminated. The NUL termination is not included in the message length. In this manual this is illustrated with NUL, ASCII 0x00.</p> <p>From OP spec. 2.0 and forward: If variable data field is used, there could be data fields that are binary, then the length of data fields are to be used as the message END determination.</p>

Note! Before binary data is sent in a message there shall always be a NUL character.

3 Implementation guidelines and Communication

This chapter describes the contact establishment procedures and the basic messages that **MUST** be implemented and handled.

It is also described how to use the messages in typical production situations.

3.1 Application Startup messages exchange

First message to send after connection is MID 0001 and expected MID 0002 as response if OK. If NOK you will get MID 0004 as response with an error code.

3.2 Message acknowledging methods

There exist two different acknowledging methods to use by using the header in two different ways, see Chapter 2.2.1. They are named as “Application Level acknowledging” and “Link Level acknowledging” methods. The integrator must choose one of these methods.

The protocol allows the implementer to do the implementation of the “Link Level acknowledging” in such a way that it will be possible to choose to use either method on message level.

If implemented in such a way and the controller supports the sequence numbering and link level acknowledging, the integrator can choose to **NOT** use the sequence numbering and link level acknowledging for a certain message by setting the sequence number to zero.

In this case the integrator must wait on the application level response for Commands, Requests and Subscriptions. If the startup was done with Rev 6 or higher the RESPONSES still will be sequence numbered and will demand a Link level acknowledging and sequence numbering handling on the Integrator side.

The same can be applicable in the direction of Controller->Integrator depending on the implementation on the Integrator side.

If it is possible to have a mix of sequence numbered/not sequence numbered messages on message level or not, is described in the reference documents for each controller, as this is implementation dependent.

Both methods are described below.

3.2.1 Application Level acknowledging method

In this method there are two MIDs used for acknowledging. The MID 0005 is the positive response and is given on a successful Command or Subscription action.

For a Request the positive response is the requested data in itself.

MID 0004 is the negative response with error codes and is given if the Request, Command or Subscription action fails for some reason.

Only one outstanding/unacknowledged message at a time is allowed before next can be sent. In other words, the implementation must wait for an MID 0004 or MID 0005 acknowledge or an direct REQUEST REPLY DATA acknowledge, depending on which type of Request, Command or Subscription that was sent, before next message can be sent.

In conjunction with this method, the No Acknowledge flag can be used for subscription data message acknowledging from the integrator side.

At MID 0004 response it is impossible to go on with the next message in a sequence, see more info under chapter “Production Message sequences”.

See retransmission rules, chapter 3.3.5, if no answer to the command is received before the response timeout.

The disadvantages with this method are that a dependency of the Application level performance will be built in for communication acknowledging being very slow sometimes and it can also be a problem with handling of retransmissions of commands already under treatment in the controller.

3.2.2 Link Level acknowledging method from OP spec. 2.0

When using the header sequence numbering the MID 9998 and MID 9997 is used for fast acknowledging and the implementation of Open Protocol consists then of an Application **Link Layer** and Application Layer.

OBS! It is really recommended and almost a mandatory to use this method instead of Application Method acknowledging due to a lot of customer reported problems during the years of OP existence, which will be solved by this OBS!.

On the Application **Link Layer** the MID 9998 and 9997 is handled and only one outstanding/unacknowledged message at a time is allowed.

The mid 0004 and MID 0005 messages are in this case to be handled as Application level messages and be acknowledged as such by the MID 9998 or MID 9997 acknowledge messages.

All special acknowledge messages for the subscription data messages shall not be used.

At connection and communication restart with MID 0001/MID 0002 exchange, the sequence number must be initialized to 01 as the first sequence number to use for data transmission and the first sequence number to expect at first data message receiving.

The sequence number must hence be held and treated independently in each direction of the Integrator-Controller communication and is wrapped around through 1-99-1.

Data message acknowledge with MID 9998 or MID 9997 shall be done as soon as the header and length check is OK with the sequence number received + 1. The new sequence number will then be the next expected in the next data message.

If the header check fails, the data message shall be acknowledged with MID 9998 with the sequence number received + 1 and an error code that specifies the type of error.

If an already acknowledged data message is received with the same sequence number again, it is a retransmission and shall be acknowledged with the same acknowledge as last time, **but no action shall be taken for application level treatment.**

If a data message sequence number is not a retransmission and neither the next expected, the acknowledge shall be the MID 9998 with an error code and the sequence number set to next expected, telling the sending part what the next expected sequence number is. The proper action to take in this situation is to do a session disconnection/reconnection for synchronizing.

See retransmission rules, chapter 3.3.5, if no MID 9998 or MID 9997 acknowledge is received before the response timeout. If the connection is taken down and a try for a new one has been initiated the sequence numbering shall be restarted at 01.

Communication example: Normal communication

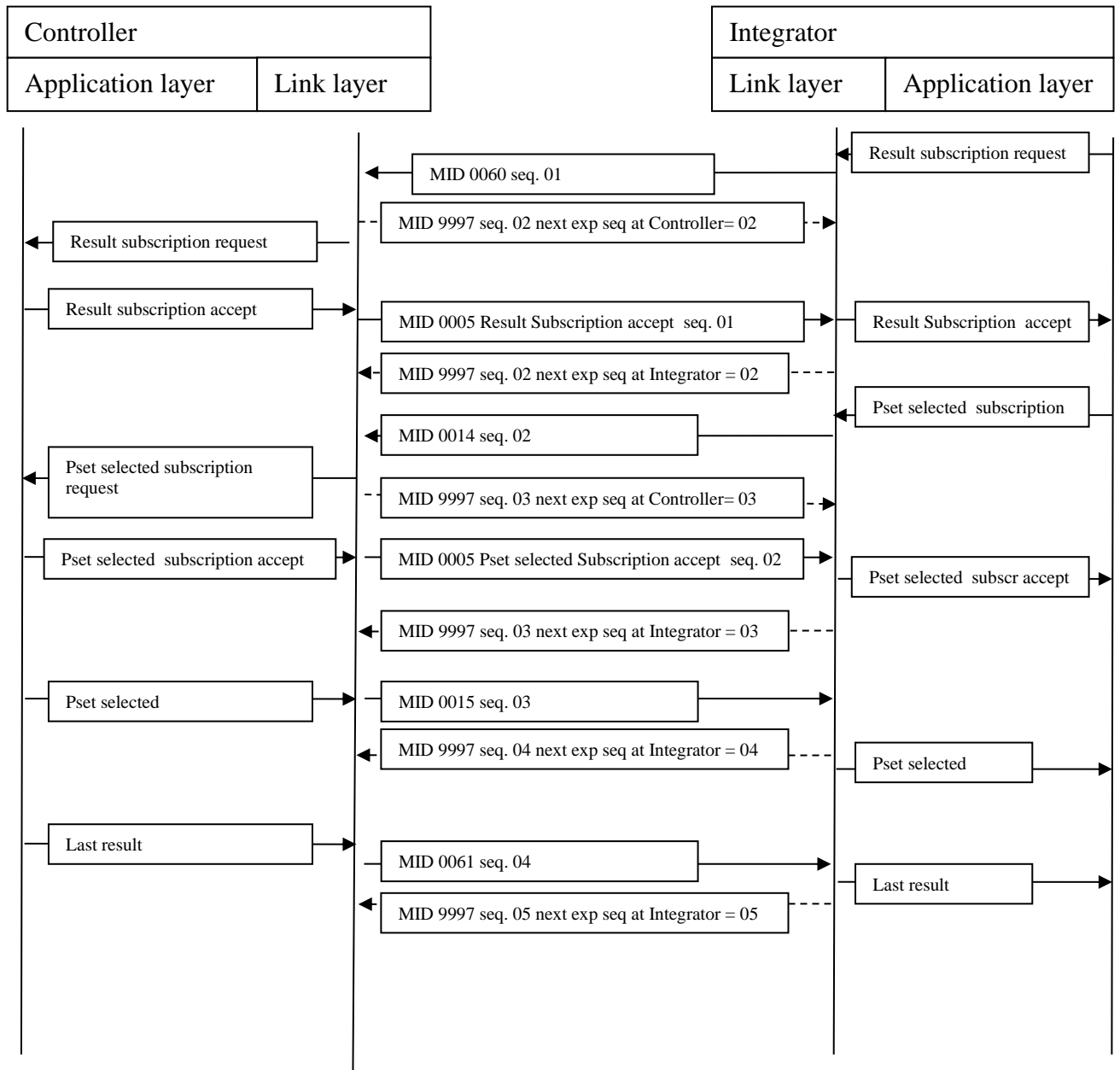

Figure 8 Normal communication

Communication example with error: No Ack received

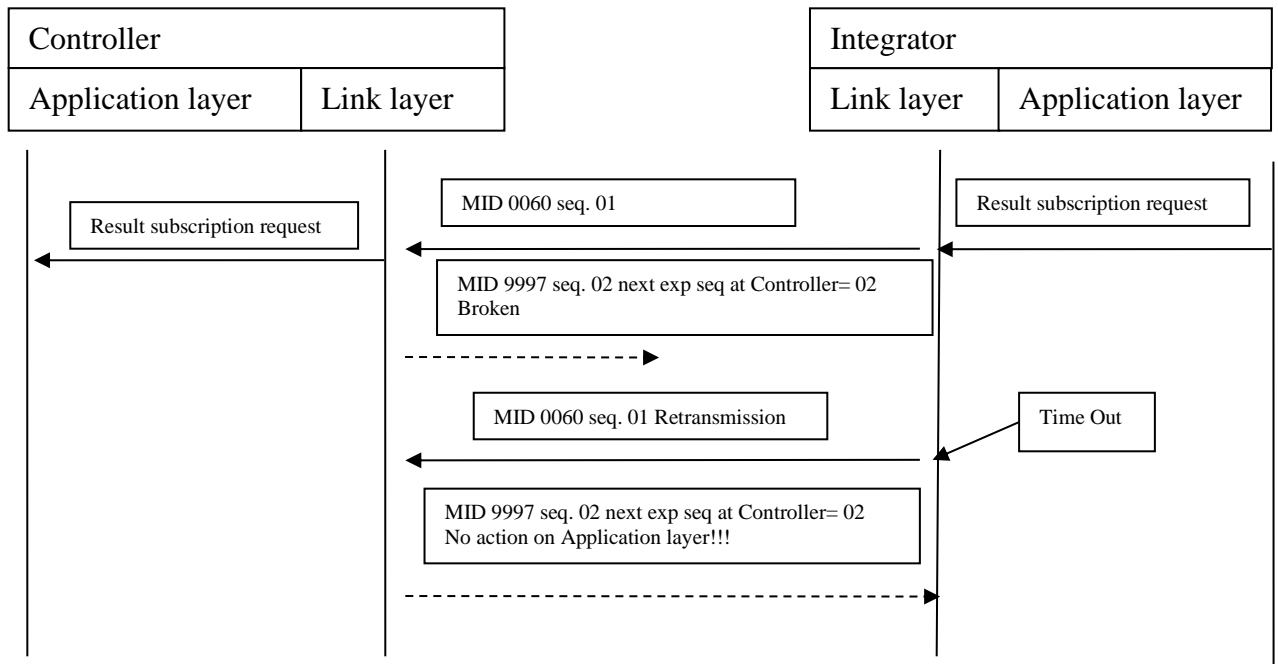

Figure 9 No Acknowledge received

Communication error: Wrong sequence number

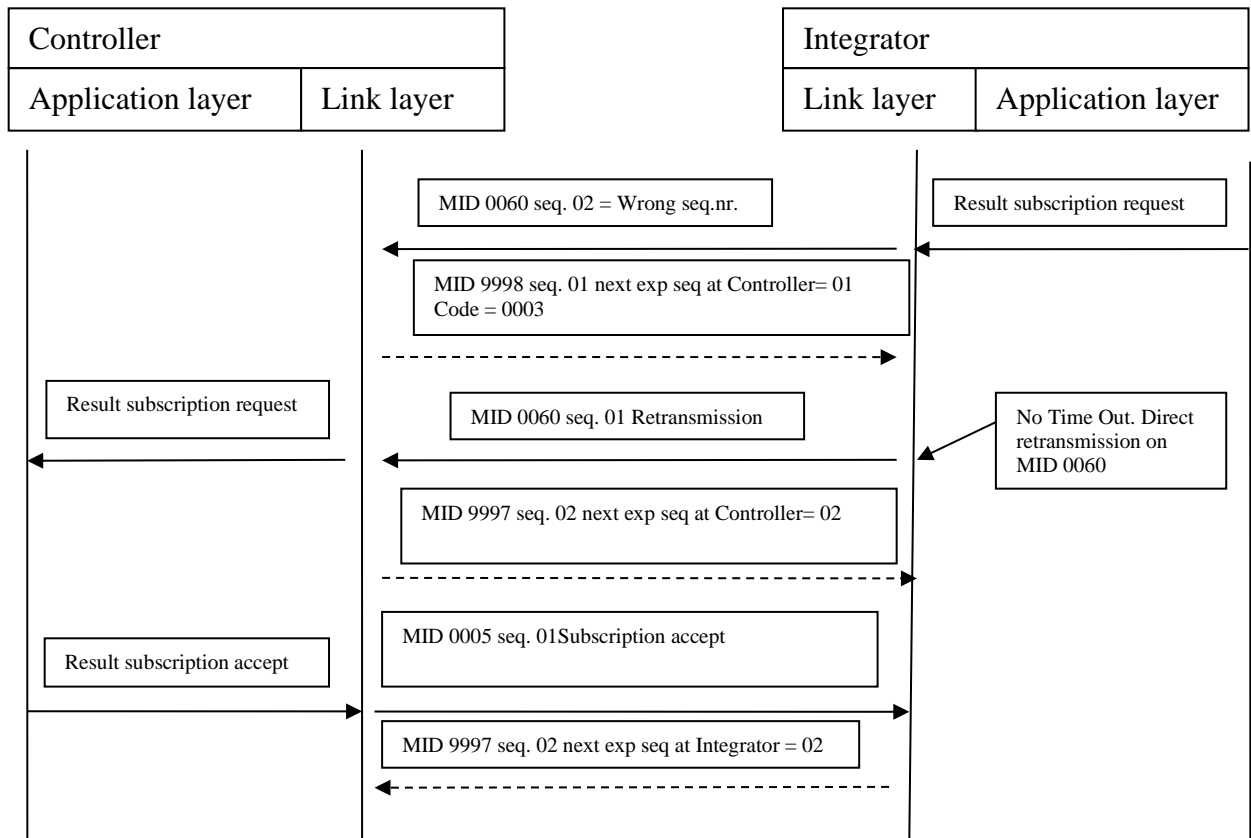

Figure 10 Wrong sequence numbering

Communication error: Transmission of data message broken

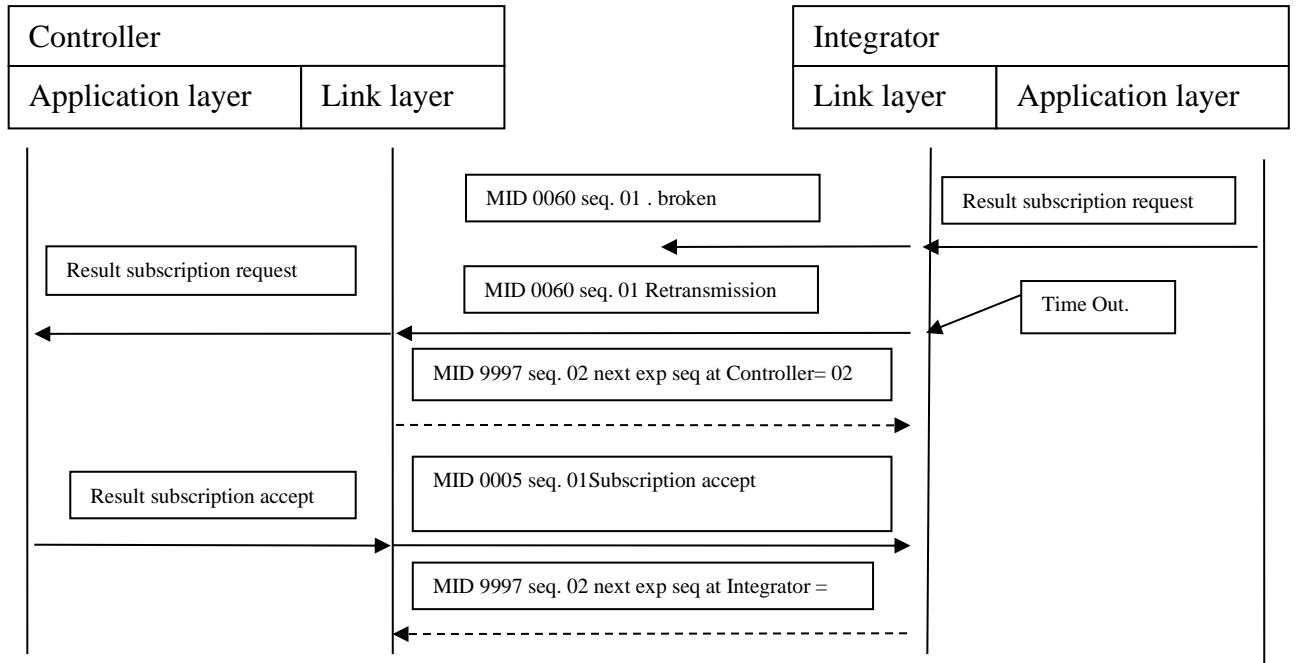

Figure 11 Transmission broken

3.3 Establishing contact

This section describes how to set up a communication.

3.3.1 Ethernet connection

The scenarios below describe a standard (default) usage of a transport layer connection i.e., TCP. See also 2.1.1 for connection details.

3.3.1.1 Scenario A

Prerequisite: The controller has an IP address and listens to port 4545.

1. The controller listens to port 4545 acting as a server.
2. The integrator connects to the controller acting as client.
3. The controller accepts the connection.
4. The integrator sends **MID 0001 Communication start.**
5. The controller answers **MID 0002 Communication start acknowledge** with Cell ID 0001, Channel ID 04 and Controller name Airbag.

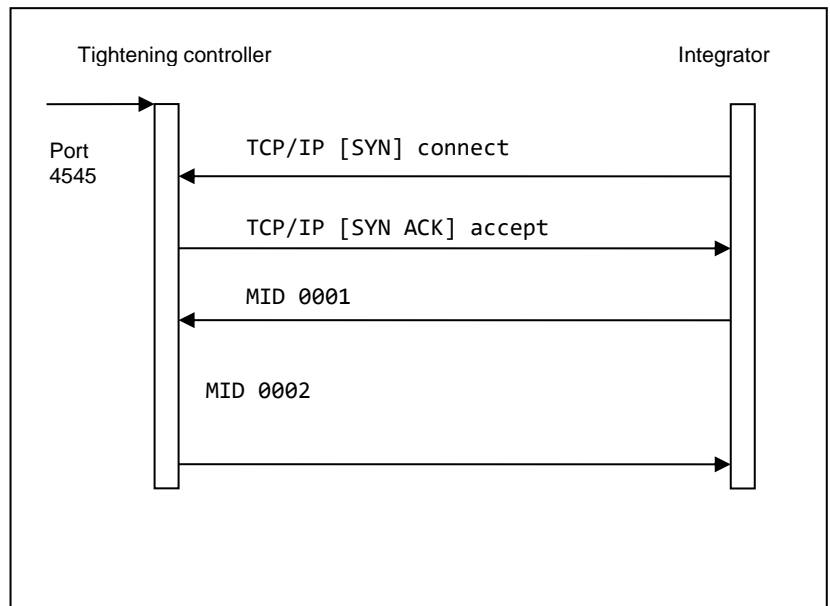

Figure 12 Ethernet connection example A

3.3.1.2 Scenario B

Prerequisite: The controller and the integrator each has an IP address, and an agreed port to use.

1. The integrator listens to the configured TCP port.
2. The controller initiates a TCP connection to the integrator.
3. The integrator accepts the connection
4. The integrator sends **MID 0001 Communication start.**
5. The controller answers **MID 0002 Communication start acknowledge** with Cell ID 0001, Channel ID 04 and Controller name Airbag.

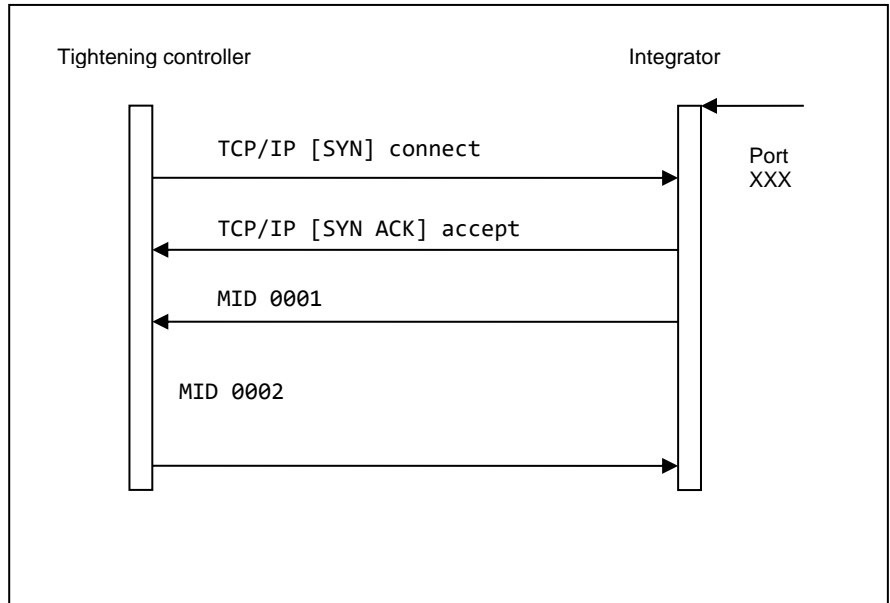

Figure 13 Ethernet connection example B

3.3.2 Serial connection

Prerequisite: The controller and the integrator are connected through a serial cable.

1. The integrator sends **MID 0001 Communication start.**
2. The controller answers **MID 0002 Communication start acknowledge** with Cell ID 0001, Channel ID 04 and Controller name Airbag.

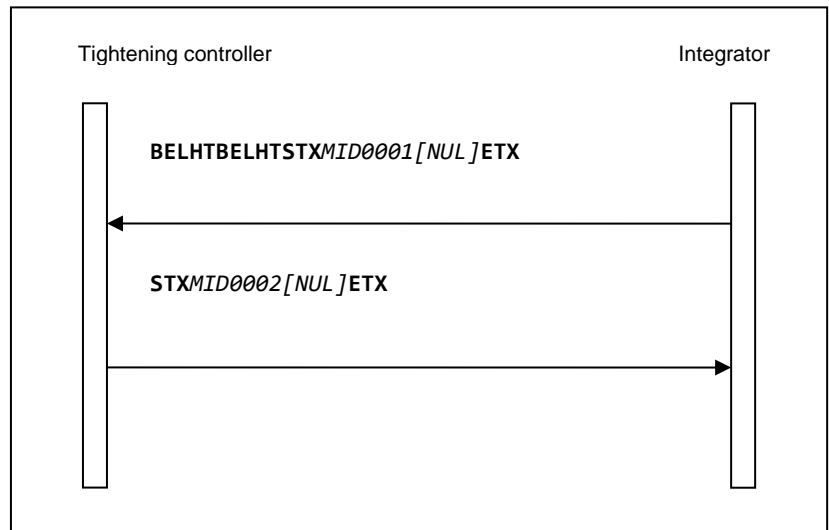

Figure 14 Serial connection example

3.3.3 Serial connection with 3964R

1. The integrator sends request for connection with the controller.
2. The controller accepts the request to send.
3. The integrator sends **MID 0001 Communication start.**
4. The controller accepts the communication.
5. The controller sends request to send on Siemens protocol.
6. The integrator accepts the communication.
7. The controller answers **MID 0002 Communication start** acknowledge with Cell ID 0001, Channel ID 04 and Controller name Airbag.
8. The integrator accepts the message.

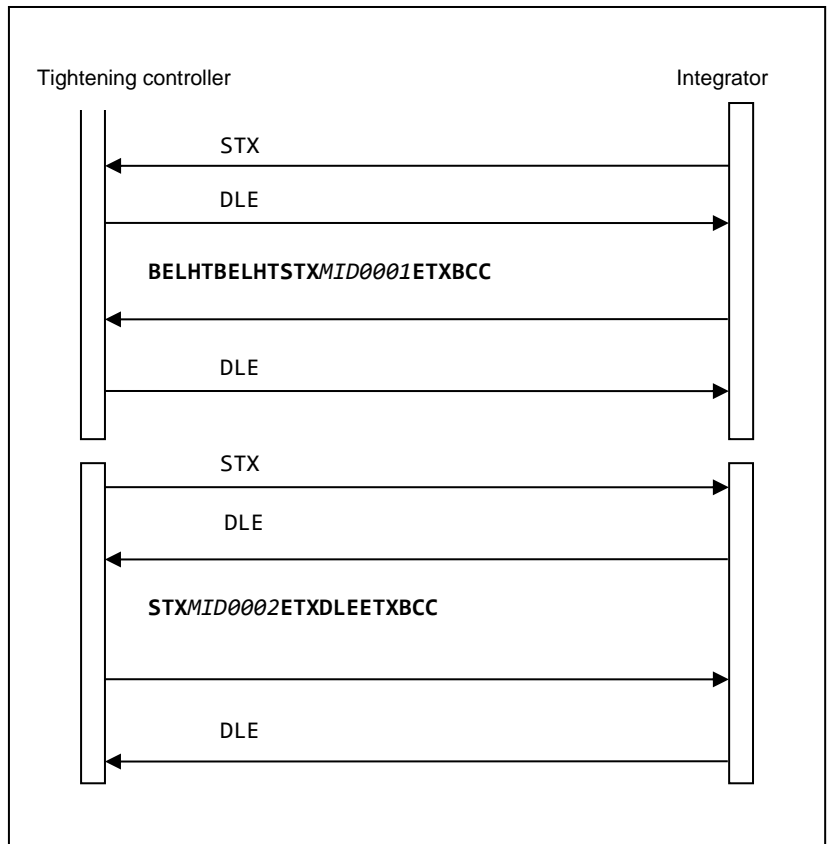

Figure 15 Serial connection with 3964R, example

3.3.4 Session control connections

Important note: When using open protocol or any other way to handle resources in the controller there might arise a resource conflict, as example enabling or disabling tool. The Actor and Viewer connections are a way to minimize the risk but will not eliminate all possible resource conflicts. Best practice is to also subscribe on the resource to be able to detect an unexpected change and in that case inform the user of the detected resource conflict.

In some controllers there is a possibility to do several Integrator side connections to the controller. These connections has the categories of being Actor, Viewer or Classic.

These categories represents MID type's categories rights to do.

From a connection of type Actor the Integrator has all rights to perform Subscriptions, Commands and Requests and if connected will preventing the Commands rights for the Viewer connection.

The Viewer connection can still do Requests and Subscriptions.

If there are a number of Classic connections and the Integrator side do an Actor connection, then these Classic connections should be transformed to Viewers.

As long as there are only Classic connections, all of them has all rights and the Integrator side must have the responsibility to prevent that several connections can do Commands at the same time.

When using connection type Actor this should be handled in the Controller implementation.

The Controller implementation can for instance realize the session control by using different TCP ports for the Actor different from the Viewer and Classic connections type.

The actual implementation is described in the Controller Open Protocol spec. documents.

Below is the overall Controller requirements for the session control functionality:

1. Connection on session for Actor shall do it impossible to do commands from other connections.
2. At connection with session for Actor it still shall be possible to do subscriptions and data requests (Upload) from all other connections transformed to Viewers.
3. At disconnection of Actor session the commands shall again be possible to do from Classic Sessions (transformed from Viewer sessions).
4. The maximum of session connections overall should be limited.
5. Tries for more than the limited session connections shall result in the MID 0004 with error code 16 "Connection rejected".
6. Tries for commands on Classis/Viewer connections when an Actor connection exists shall result in a MID 0004 with error code 92 = "Commands is disabled".
7. Tries for another Actor connection shall result in MID 0004 with error code 35 "Other Actor client already connected"

3.3.5 Retransmission rules

When missing a reply, the controller or integrator may re-send the message up to three times. After this the connection shall be considered lost and a new connection must be established.

When using link layer with modern protocols, i.e. TCP, which has its own re-send mechanisms there is no need to add more re-sends on top of the ones already existing in the session layer. In this case the timeout in Open Protocol shall be adopted to the timeout times used in the session layer. When reaching a timeout, the connection shall also be considered lost and a new connection must be established.

For TCP the normal setting is to re-send the message three times with a three second timeout, so a suitable timeout in Open Protocol could be 10 seconds.

If there are no retransmissions in the session layer the Open Protocol layer must re-send messages three times.

See also [MID 9999](#) in chapter 5.28.1 regarding timeouts.

3.4 Starting a subscription

The example shows the sequence for **MID 0060 Last tightening data subscribe** and **MID 0061 Last tightening data upload**. These messages must be implemented to get results. Prerequisite: A communication session is already established. The example shows only the data sent, not the protocol frames. Dotted lines are for when using sequence numbering with MID 9997 and MID 9998 acknowledging. The figures don't show the different layers at sequenced numbering use.

1. The integrator sends **MID 0060 Last tightening result data subscribe**. The subscription is for revision number 6.
 2. The controller sends MID 9997 if sequence numbering is used and **MID 0005 Command accepted** (As application message if sequence numbering is used).
 3. A tightening is performed. (See arrow in figure.)
 4. The controller sends **MID 0061 Last tightening result data upload** and then waits for acknowledgement.
- See description of MID 0061.
- The integrator sends **MID 0062 Last tightening result data acknowledge** OR **MID 9997** when sequence numbering is used.

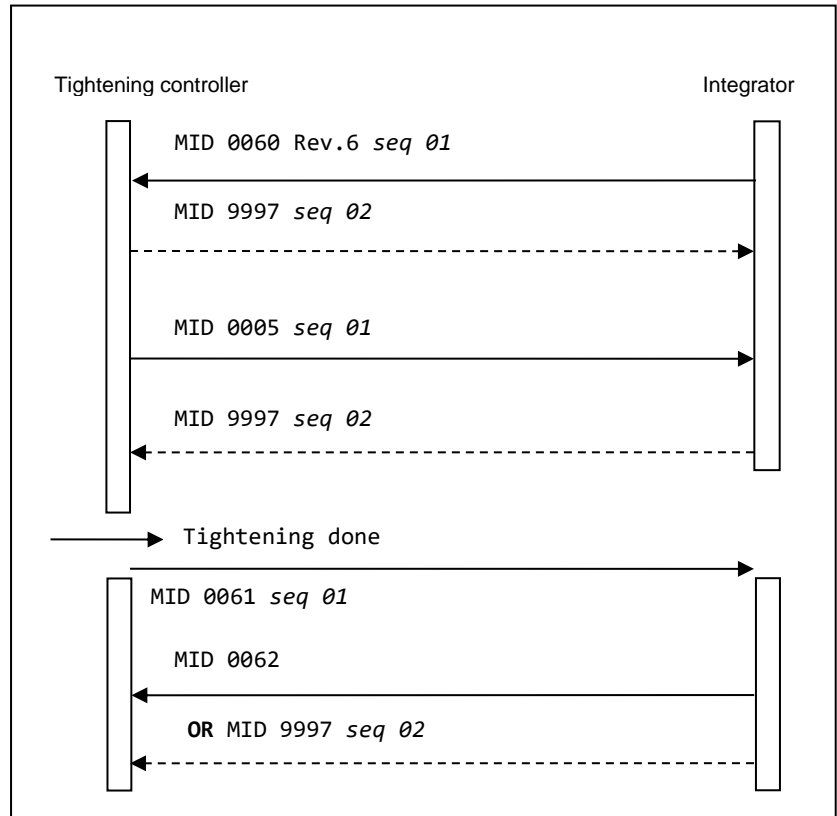

Figure 16 Starting a subscription

3.5 Sending a request

This example shows a request for collecting parameter set data. Dotted lines are for when using sequence numbering with MID 9998 and MID 9997 acknowledging.

1. The integrator sends **MID 0012 Parameter set data upload request.**

The request is sent for parameter set number 001.

2. The controller sends **MID 0013 Parameter set data upload reply** if OK. For a description of the parameters, see MID 0013 description. If error, a response of MID 0004 with error code is sent from the Controller.

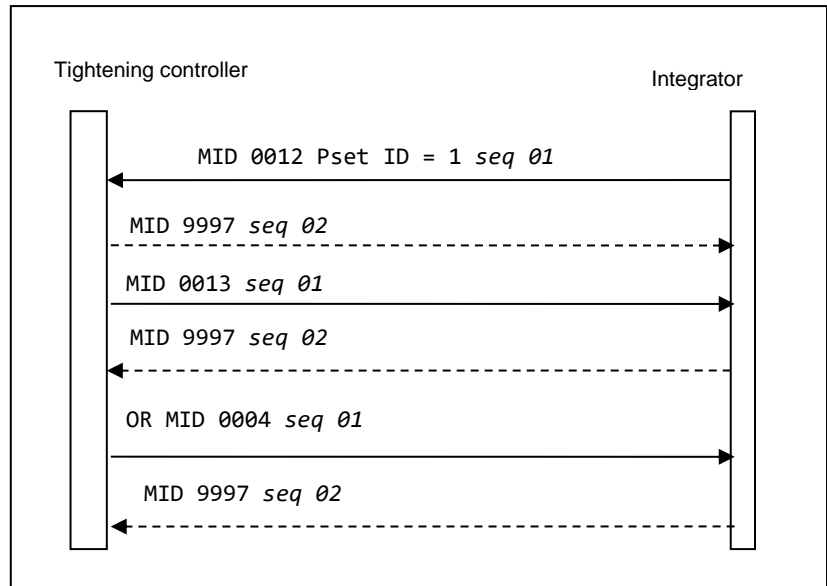

Figure 17 Sending a request

3.6 Sending a command

This example shows a command for setting primary tool. Dotted lines are for when using sequence numbering with MID 9998 and MID 9997 acknowledging.

1. The integrator sends
MID 0041 Set Primary tool.
The request is sent for primary
tool = 1

2. The controller sends
**MID 0005 if the command has
been performed.** Otherwise the
MID 0004 is sent with an error
code.

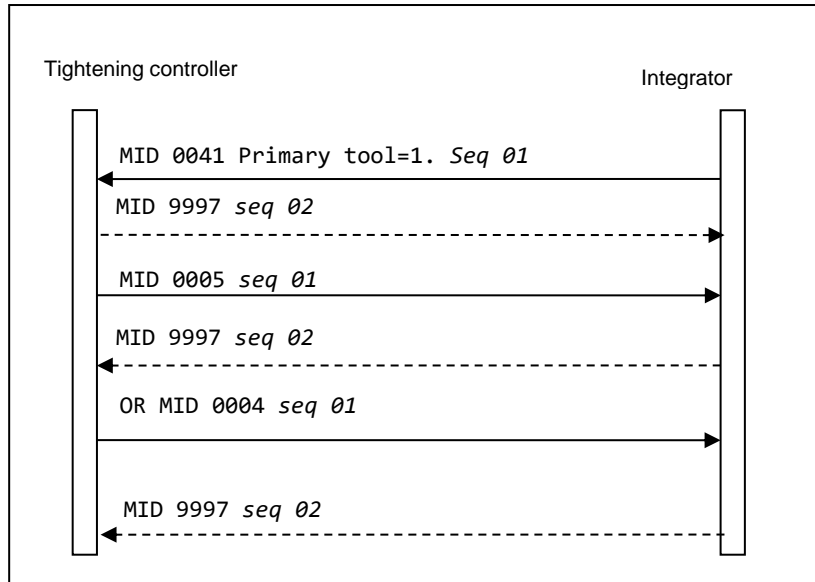

Figure 18 Send a command

3.7 MES ruled production message sequences

Examples of typical application level message sequences to use in a production.

3.7.1 General Job/Work order selection rules

Regardless of used Controller or MES system all new selections for starting new tightening cycles SHALL start with sending the Job Abortion/Result request command to the Controller. This is especially important when wireless tools are connected to the Controller with a wireless link going down and up now and then and when a current Job Work order is really interrupted by the MES sending a Job abortion command. If the MES isn't capable of executing a Job abortion/result request command, the PF will do it itself at Job Work order receiving.

The functionality of the Job Abortion/Result request command implementation contains the following:

1. A cleanup of the controller and the tool from any possible remaining work and results in a possible current selected Job.
2. Securing of that all results done from the current Job will be reported with proper and true build data such as VIN number etc., if any, to the MES, before executing the Job abortion and entering the new Work order.
3. The MES has to wait for an MID 0005 acknowledge and optionally Job Info message with Job aborted status, before issuing any of the Work order commands if the Job abortion command is used.
4. In the meantime the Controller goes into a "Job abortion in progress" state since it can take some time to perform the Job abortion clean up.
5. For wireless tools it is included in the Job abortion clean up implementation, to check up whether the tool has any remaining results not reported yet by asking the tool, and see to, that these results will be received by the MES PF interface and if possible be reported to the MES before the actual Job abortion command is executed.

NOTE: The reporting of such results should be parameterized to be sent, YES or NO.

6. At tool going inaccessible during the Job abortion/result request process, it will take more time to report the possible remaining results and this will not be finished before the tool goes accessible again and after results reporting. In this case the MES PF interface will acknowledge the Work order with MID 0004 and error code for "Tool inaccessible".

NOTE: The behavior of this is recommended to be parameterized like: "Job abortion after all remaining results reported" or "Job abortion if the tool is or goes inaccessible during the result request process" or "Unconditional Job abortion". At the two last alternatives it is recommended to store the results as "latent" marked in the controller's database and also use the Toolsnet.

7. At tool accessible during the process of Job abortion/Result request the Work order command will be acknowledged with MID 0005 when the Job has been aborted and/or all possible remaining results has been received by the MES Interface and if possible reported to the MES.

8. New commands for Work order from the MES, during the time for Job abortion in progress and transferring of possible remaining results, are acknowledged with MID 0004 with error code for "Job abortion in progress". It is the MES responsibility to have knowledge of rejected Work orders.

9. New commands for Work order in the state of “Tool inaccessible” is acknowledged with MID 0004 with error code for “Tool inaccessible” if parameterized to “Job abortion after all remaining results reported”.

The Job abortion/Result request process is valid for the following methods of selecting a new Work order from the MES:

1. VIN number selection of Pset, Multistage or Job if so configured in the controller, MID 0050 or MID 0152.
2. Job selection command, MID 0038
3. Job selection through Executing Dynamic Job command, MID 0140
4. Pset or Multistage selection command, Dynamic Job embedded MID 2504

Also the following commands related to a Work order selection are acknowledge with MID 0004 with error codes as above during the circumstances of “Job abortion in progress” or “Tool inaccessible” and parameterized to “Job abortion after all remaining results reported”:

1. Disable tool, MID 0042
2. Enable tool, MID 0043
3. Vin number, MID 0050
4. Set Pset Batch, MID 0019
5. Reset Pset Batch, MID 0020
6. Restart Job, MID 0039
7. Job Batch increment, MID 0128
8. Job Batch decrement, MID 0129
9. Multi Identifiers MID 0152

Communication sequences Example:

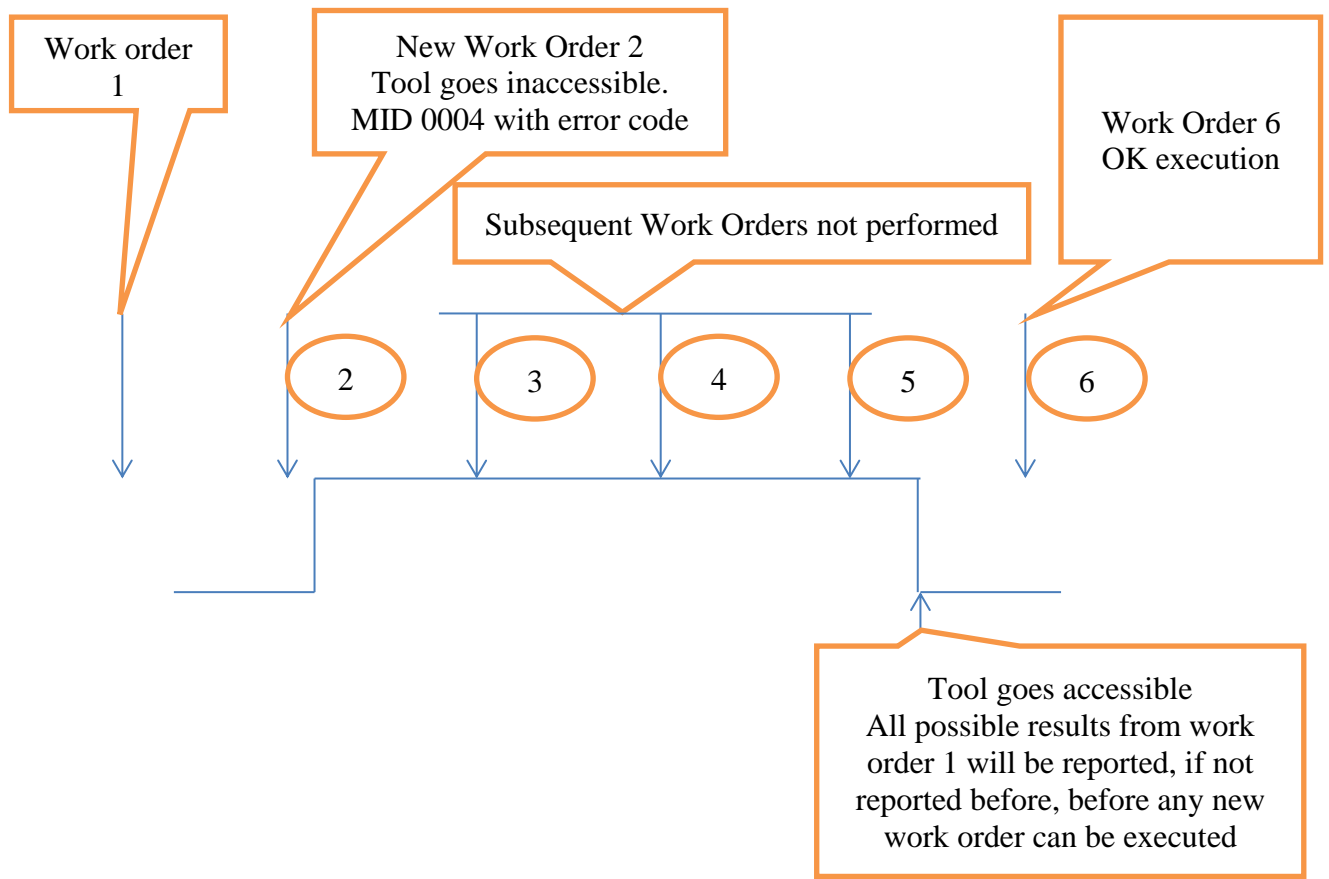

Figure 19 Work Order example at parameterized to “Job abortion after all remaining results reported”

3.7.2 Production Control by Pset selection and tightening

After start up sequence the integrator should send the following messages once:

Request for Pset ID:s. MID 0010 and MID 0011 handling.

Subscription on Pset selected. MID 0014 – MID 0017 handling

Subscription on VIN number set according to MID 0050 – MID 0054 or MID 0150 – MID 0157 handling

Subscription on locked at batch done. MID 0021-MID 0024 handling. Parameter in PF set (P152 for PF 4000).

Subscription on Last tightening results. MID 0060-MID 0063 handling.

Subscription on selectable digital inputs as ex. Tool Running/Not Running. MID 0210 and MID 0211 handling

Set primary tool request (Optional. Could already been set in PF). MID 0046

At wireless tools use the Pairing Handling (Optional. Could already been done PF locally). MID 0047 and MID 0048.

After that, the production can start with use of the following messages:

- Command Abort Job. MID 0127.
- Command Select Pset MID 0018.
- Command Set VIN. MID 0050 or MID 0150 handling
- Command Disable Tool. MID 0042.
- Command Enable Tool. MID 0043.

3.7.2.1 Sequence at production start up

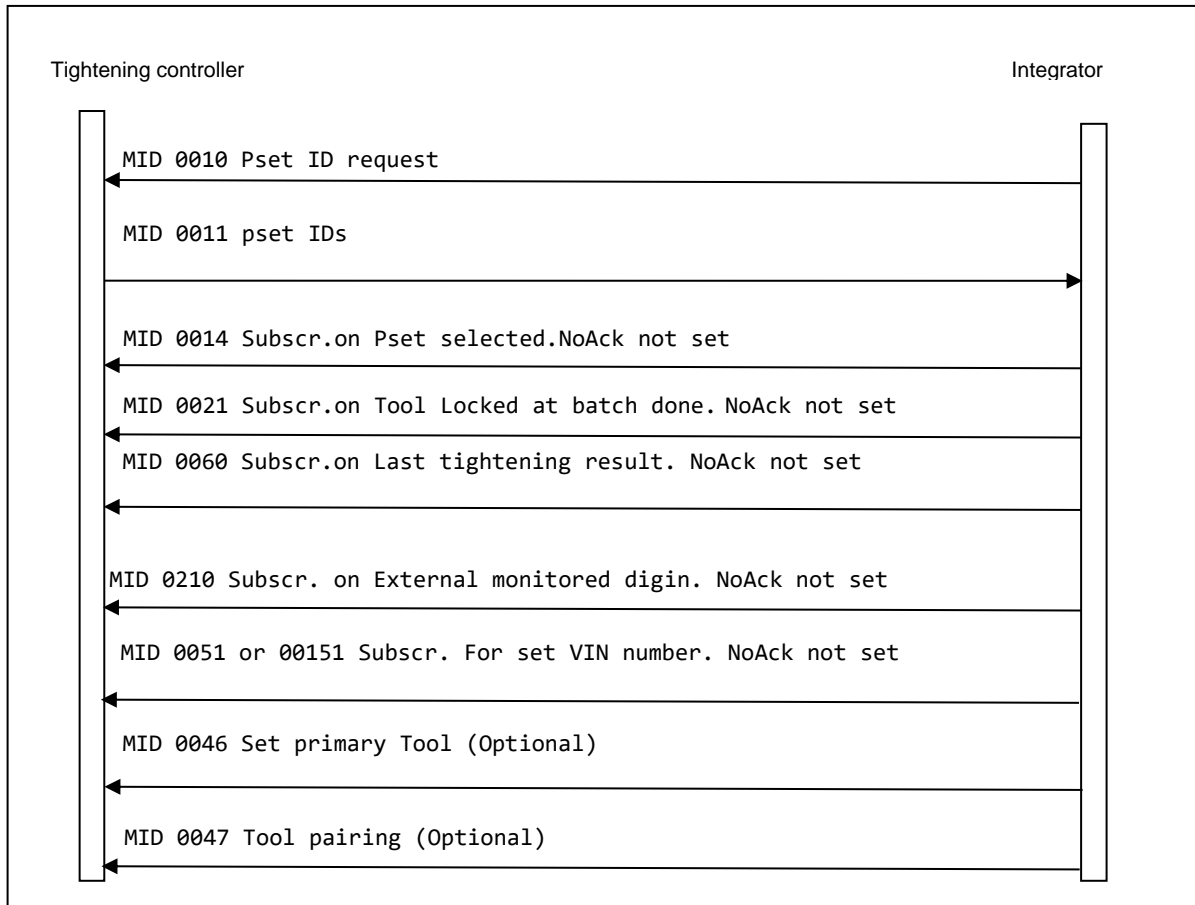

Figure 20 Production startup Pset selection

Important: If at any of the above stages an MID 0004 is received, the intended production can not be started. The integrator side must wait on the MID 0005.

3.7.2.2 Sequences at running production

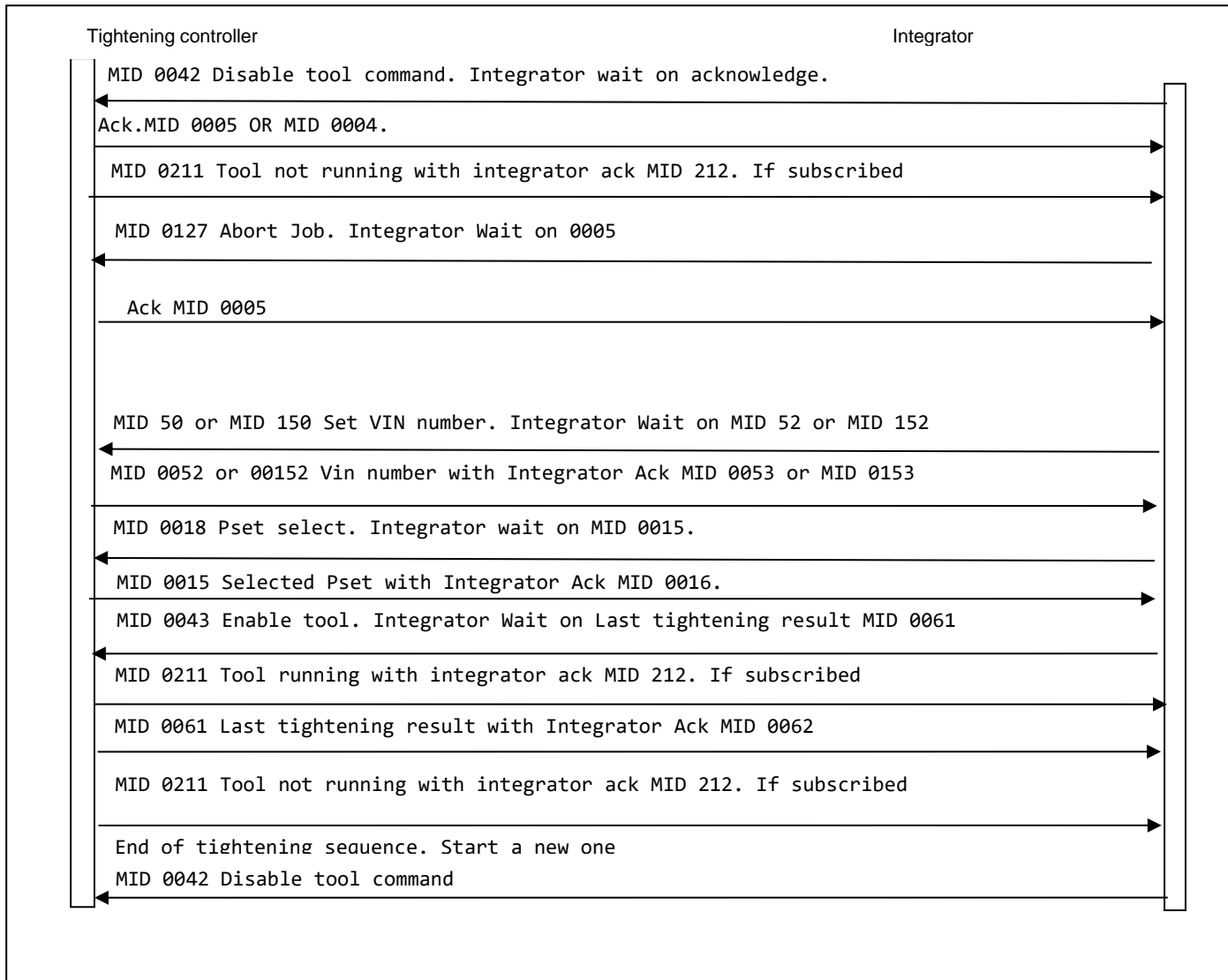

Figure 21 Running production at Pset selection

Important: If at any of the above stages an MID 0004 is received, the intended production cannot be started. The integrator side must wait on the MID 0005.

3.7.3 Production control by Job selection and tightening

PF locally configuration used with a number of Jobs configured below the summary of used messages.

After start up sequence the integrator should send the following messages ones:

Request for Job ID:s. MID 0030 and MID 0031 handling.

Subscription on Job Info. MID 0034 – MID 0037 handling.

Subscription on VIN number set according to MID 0050 – MID 0054 or MID 0150 – MID 0157 handling.

Use Job Info status. Or use Lock at Job done Parameter in PF set (J 302 for PF 4000).

Subscription on Last tightening results. MID 0060 – MID 0063 handling.

Subscription on selectable digins as ex. Tool Running/Not Running. MID 0210 and MID 0211 handling.

Set primary tool request (Optional. Could already been set in PF). MID 0046.

At wireless tools use the Pairing Handling (Optional. Could already been done PF locally). MID 0047 and MID 0048.

After that, the production can start with use of the following commands:

- Command Abort Job. MID 0127.
- Command Select Job MID 0038
- Command Set VIN. MID 0050 or MID 0150 handling
- Command Disable Tool. MID 0042.
- Command Enable Tool. MID 0043.

3.7.3.1 Sequence at production start up

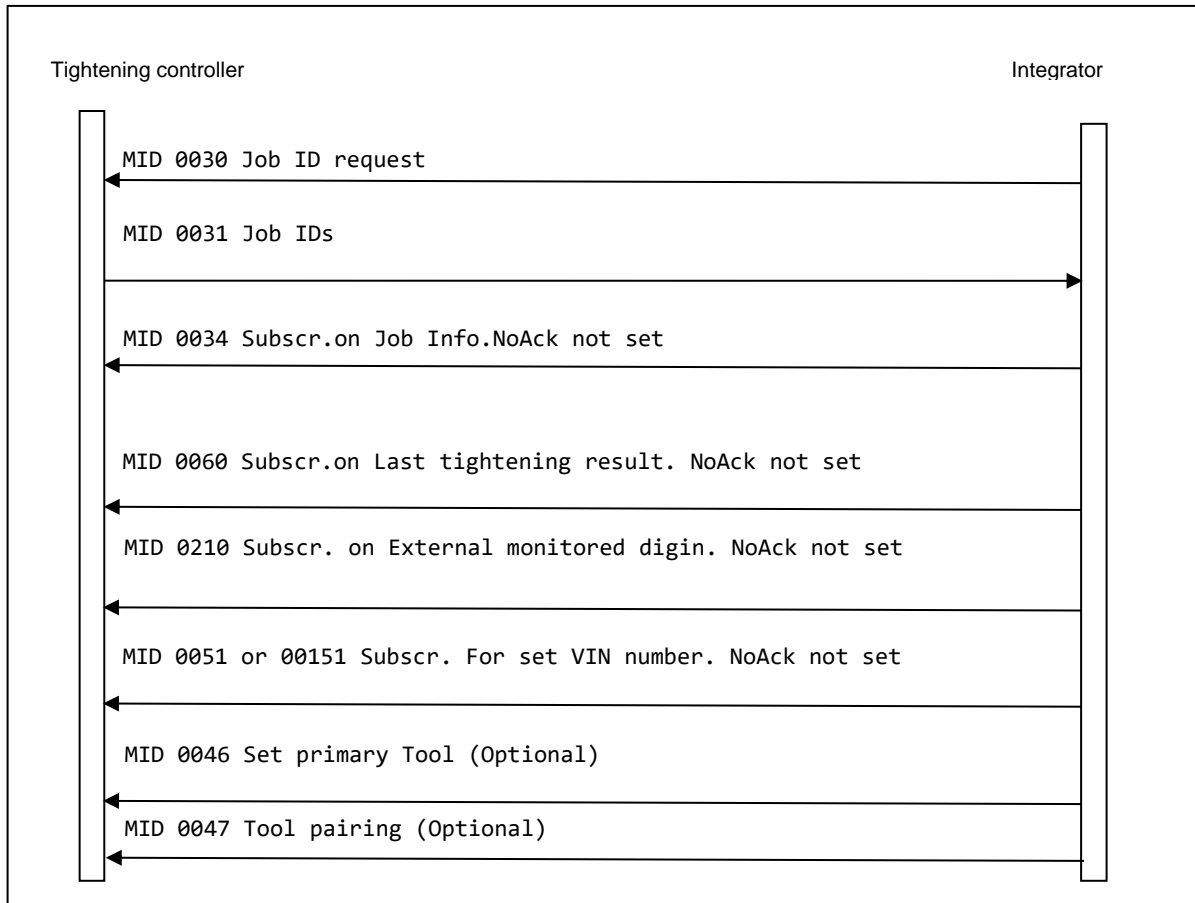

Figure 22 Production startup at Job selection

Important: If at any of the above stages an MID 0004 is received, the intended production cannot be started. The integrator side must wait on the MID 0005.

3.7.3.2 Sequences at running production

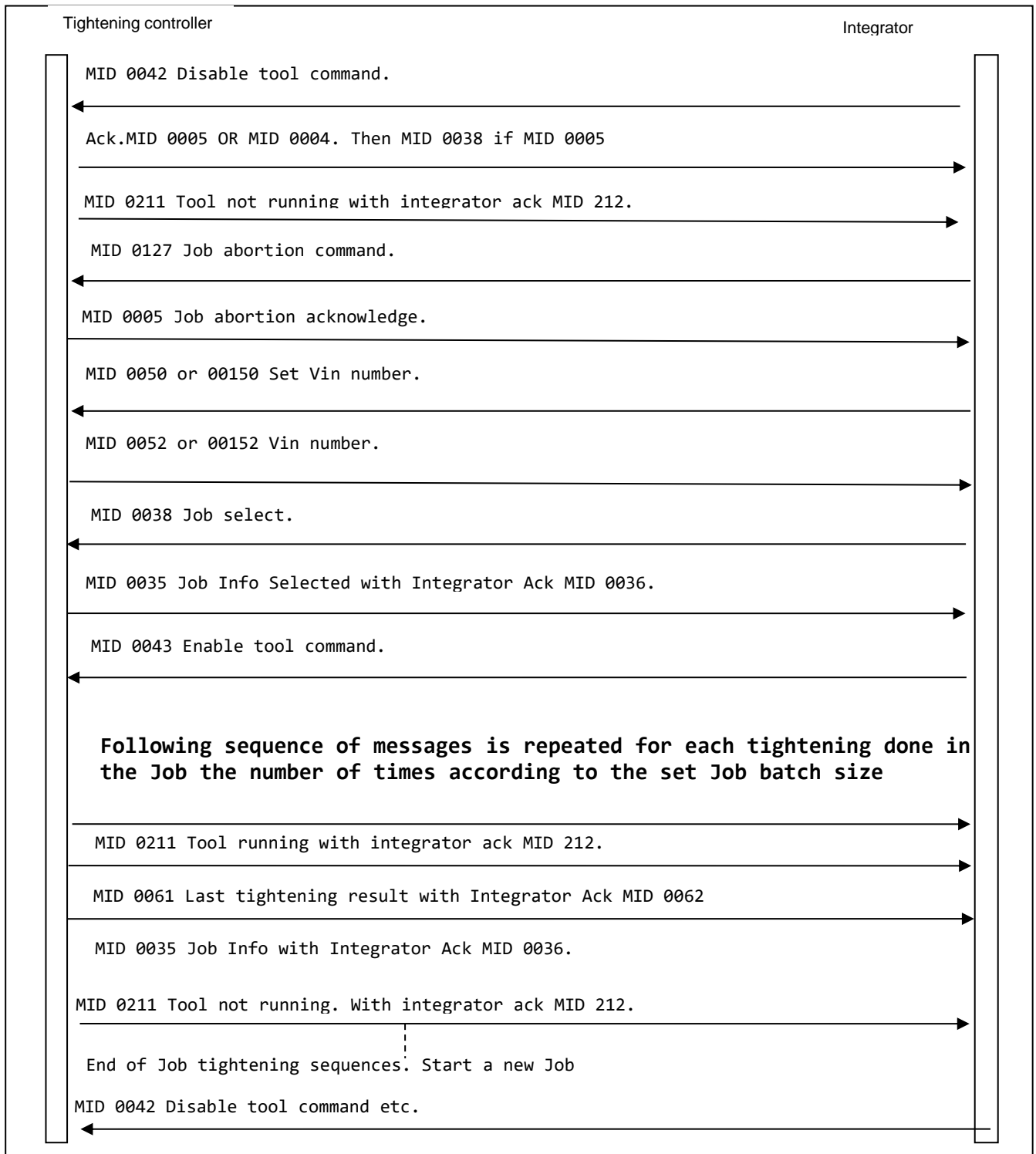

Figure 23 Running production at Job selection

Important: If at any of the above stages an MID 0004 is received, the intended production can not be started. The integrator side must wait on the MID 0005.

3.8 Message End determination methods

To determinate the end of the message the implementer must check the length (in the header 2.2.2) of message not just the NUL character.

This is due to that it not just ASCII based data that is sent. For the variable data fields containing a lot of data the data is sent in binary formats.

Before binary data is sent in a telegram there shall be a NUL character sent to simplify the interpretation of the message.

3.9 Version 2.0 implementation description

To be FULLY compliant with version 2.0 of this protocol the following MID's and functionality must be implemented, both in the controller and integrator side.

On which level the controller side is living up to version 2.0 shall be described in [ref](#).documents.

3.9.1 Startup

Startup with MID 0001 with at least Rev 6 or higher and receiving of MID0002 with revision 6 or higher.

3.9.2 Link level acknowledging

[The link level message sequence numbering](#), acknowledging and retransmission method with MIDs 9997 and 9998 acknowledging messages.

Used for ALL subscription data messages it will substitute the following messages:

MIDs 0016, 0023, 0036, 0053, 0062, 0092, 0102, 0125, 0153, 0212, 0218, 0222, 0243, 0252, 0263, 0402, 0422, 0502, 1203, 2605 and 8002.

All together 22 MID messages.

Furthermore will it give retransmission detection possibility and full acknowledging control in both directions for ALL MIDs.

3.9.3 Generic Application data request

Generic Application data request is done through MID 0006.

Used for ALL possible application data requests it substitutes the following current messages:

MIDs 0010, 0012, 0030, 0032, 0040, 0081, 0214, 0300, 0310 and 0360

All together 10 MID messages

3.9.4 Generic Application data subscription

Generic Application data subscriptions is done through MID 0008 and 0009.

Used for ALL possible application data subscriptions they substitutes the following current messages:

MIDs 0014, 0017, 0021, 0024, 0034, 0037, 0051, 0054, 0060, 0063, 0070, 0073, 0090, 0093, 0100, 0103, 0105, 0109, 0120, 0126, 0151, 0154, 0210, 0213, 0216, 0219, 0220, 0223, 0241, 0244, 0250, 0253, 0261, 0264, 0400, 0403, 0420, 0423, 0500, and 0503

All together 40 MID messages.

3.9.5 Data field variable parameter pattern

MIDs can be sent in either variable parameter data fields' pattern or in the static variable fields pattern as described in [Message Structure](#).

In version 2.0 the variable data field pattern was introduced, and the possibility to parse such a MID message must be implemented in both controller and integrator side.

The use of the variable parameter pattern data fields are described at each MID description that uses it.

MIDs that use the variable parameter pattern so far is:

Table 6 Messages using the variable parameter pattern

MID	Name	Description
0067	Tightening Result List Upload	Generic message to get a list of results in the controller
0900	MID 0900 Trace curve data message	Generic Trace sample message with first an ASCII part, thereafter a binary part containing the actual curve sample data
0901	MID 0901 Traces Plot Parameters Message	Generic message for limits plotting in the trace curve.
2500	MID 2500 Tightening Program Message download	Generic Parameters download for a number of node types. See the MID description chapter
2501	MID 2501 Tightening Program Message Upload	Generic Parameters upload for a number of node types. See the MID description chapter.
1200	MID 1200 Last result operation overall data	Generic result message in overall structure
1201	MID 1201 Operation result Overall data	Generic result message in detailed structure
0700	MID 0700 Tightening data download status	Used for radio connected tools
2505	MID 2505 Select Parameter set dynamically.	A number of PIDs for Pset change and substitution of a number of commands.
0702	MID 0702 Tool Data upload reply with generic data	Generic tool information in variable parameter structure
0703	MID 0703 Set calibration value request with generic data	Generic calibration information in variable parameter structure

MID	Name	Description
0704	MID 0704 Tool Data status reply with generic data	Request for specific tool parameters
0902	MID 0902 Tightening Result DB Info Upload	Request for Result database information
1900	MID 1900 Selector socket info	Message sent each time a socket is lifted or put back in position
1901	MID 1901 Selector socket control	Message to control the selector lights.
2506	MID 2506 Tightening Program Delete	Request to delete tightening programs

All new MIDs will follow the version 2.0 variable parameter pattern structure and at every need of adding any more data parameters to any of the existing MIDs using the static variable pattern, the MID will be transformed to the new version 2.0 variable data field parameter pattern with a new MID number.

4 Message categories

Most, but not all, messages can be sorted into three main categories. **MID 0001 Communication start** or **MID 0003 Communication stop**, do not belong to any of these categories.

The categories are:

- Request messages
- Command messages
- Subscription messages
- Keep alive

4.1 Application Request and Request reply messages

The integrator sends a request to the controller and the controller responds to the request with the requested data or a negative, 0004 reply.

Example of Request and Request reply messages:

- The integrator sends **MID 0012 Parameter set data upload request**
- The controller answers **MID 0013 PSET data** or **MID 0004 Command error, PSET does not exist**.

In general all requested data MIDs upload is sent from the controller without any demand on acknowledging on application level from the integrator side.

Furthermore the integrator shall wait directly on the requested data upload and consider this as a positive acknowledge on the request. If an MID 0004 is the response the integrator must probably correct the error.

See also at each Request MID description about the use of MID 0004.

4.1.1 Generic Request message

When MID 0006 generic application data request is used it substitutes all special MIDs data requests.

4.2 Application Command and Command reply messages

The integrator sends a command to the controller and the controller responds to the command with a positive (0005) or negative (0004) reply. See retransmission rules, chapter 3.3.5, if no answer to the command is received before the response timeout.

Example of command and command reply messages:

The integrator sends **MID 0018 Select Parameter set**

The controller answers **MID 0005 Command accepted** or **MID 0004 Command error**

4.3 Application Subscription Messages

The subscription messages can be divided into four categories:

- Subscribe/Unsubscribe messages for event data/subscription data messages
- Subscription data messages
- Subscription data messages acknowledge messages
- Generic subscription/Unsubscription messages for event data/subscription data messages

The integrator sends the Subscribe/Unsubscribe messages to the controller and the controller responds to the command with a positive (0005) or negative (0004) reply. See retransmission rules, chapter 3.3.5, if no answer to the command is received before the response timeout.

4.3.1 Event data Subscribe/ Unsubscribe messages

The subscription is made with the Subscribe/Unsubscribe message. The subscription can be cancelled at any time by the integrator by sending an unsubscribe message.

4.3.2 Subscribed data messages

The controller can spontaneously send messages to the integrator after an event such as a tightening or an alarm. This service is only enabled after a subscription event message.

4.3.3 Subscribed data message acknowledge

Depending on the subscription message "No Acknowledge Flag" settings in the message header the integrator is acknowledging or not acknowledging. If the flag is NOT set the integrator shall acknowledge the data event messages by sending the corresponding acknowledge MID, otherwise not. See retransmission rules, chapter 3.3.5, if no acknowledge is received before the response timeout.

4.3.4 Generic Subscription/Unsubscription messages

When MID 0008 and MID 0009 subscription messages are used they substitute all special MIDs subscription/unsubscription messages.

4.3.5 Subscription/Unsubscription messages handling when sequence numbering and Link level acknowledging is used.

If the sequence numbering and MID 9997 and MID 9998 acknowledge treatment is used they substitute all subscription data acknowledge messages as well as the "No Ack" flag in the header.

4.4 Programming control

Some command MIDs in some controller products require an exclusive access to the controller called “programming control”. Programming control can be compared to a regular lock needed to perform programming tasks. To checkout if a specific controller requests for programming control and password handling, look into the reference documents list for each controller.

The concerned MIDs that requires that programming control is available (i.e. the lock shall be unlocked) in order to execute, take programming control during the time of execution of the command (i.e. they lock the lock), and then automatically release programming control (i.e. automatically unlock the lock).

If programming control is not available when sending such a MID (i.e. the lock is already locked), the controller answers with **MID 0004 Command error, Programming control not granted**.

When a command MID requires programming control, this is indicated as a warning in the MID specification.

4.5 Message list

The section lists all available messages.

Table 7 Available messages

MID	Description	Sent by	Request message	Request reply message	Event subscription	Events	Event Acknowledge	Open Protocol command
0001	Application Communication start	Integrator	X					
0002	Application Communication start acknowledge	Controller		X				
0003	Application Communication stop	Integrator	X					
0004	Application Command error	Controller	X					
0005	Application Command accepted	Controller	X					
0006	Application generic data request	Integrator.	X					
0008	Application generic subscription	Integrator				X		
0009	Application generic unsubscribe	Integrator				X		
0010	Parameter set ID upload request	Integrator	X					
0011	Parameter set ID upload reply	Controller		X				
0012	Parameter set data upload request	Integrator	X					
0013	Parameter set data upload reply	Controller		X				
0014	Parameter set selected subscribe	Integrator			X			
0015	Parameter set selected	Controller				X		
0016	Parameter set selected acknowledge	Integrator					X	
0017	Parameter set selected unsubscribe	Integrator			X			
0018	Select Parameter set	Integrator	X					X
0019	Set Parameter set batch size	Integrator	X					X
0020	Reset Parameter set batch counter	Integrator	X					X
0021	Lock at batch done subscribe	Integrator			X			
0022	Lock at batch done upload	Controller				X		
0023	Lock at batch done upload acknowledge	Integrator					X	
0024	Lock at batch done unsubscribe	Integrator			X			
0025	Parameter user set download request	Integrator	X					
0030	Job ID upload request	Integrator	X					
0031	Job ID upload reply	Controller		X				
0032	Job data upload request	Integrator	X					
0033	Job data upload reply	Controller		X				
0034	Job info subscribe	Integrator			X			
0035	Job info	Controller				X		
0036	Job info acknowledge	Integrator					X	
0037	Job info unsubscribe	Integrator			X			
0038	Select Job	Integrator	X					X
0039	Job restart	Integrator	X					X
0040	Tool data upload request	Integrator	X					

Message categories

MID	Description	Sent by	Request message	Request reply message	Event subscription	Events	Event Acknowledge	Open Protocol command
0041	Tool data upload reply	Controller		X				
0042	Disable tool	Integrator	X					X
0043	Enable tool	Integrator	X					X
0044	Disconnect tool request	Integrator	X					X
0045	Set calibration value request	Integrator	X					X
0046	Set primary tool request	Integrator	X					X
0047	Pairing Handling	Integrator	X					X
0048	Pairing Status	Controller				X		
0050	Vehicle ID number download request	Integrator	X					X
0051	Vehicle ID number subscribe	Integrator			X			
0052	Vehicle ID number	Controller				X		
0053	Vehicle ID number acknowledge	Integrator					X	
0054	Vehicle ID number unsubscribe	Integrator			X			
0060	Last tightening result data subscribe	Integrator			X			
0061	Last tightening result data	Controller				X		
0062	Last tightening result data acknowledge	Integrator					X	
0063	Last tightening result data unsubscribe	Integrator			X			
0064	Old tightening result upload request	Integrator	X					
0065	Old tightening result upload reply	Controller		X				
0066	Number of offline results	Controller		X				
0067	Tightening Result List Upload	Controller		X				
0070	Alarm subscribe	Integrator			X			
0071	Alarm	Controller				X		
0072	Alarm acknowledge	Integrator					X	
0073	Alarm unsubscribe	Integrator			X			
0074	Alarm acknowledged on controller	Controller				X		
0075	Alarm acknowledged on controller acknowledge	Integrator					X	
0076	Alarm status	Controller				X		
0077	Alarm status acknowledge	Integrator					X	
0078	Acknowledge alarm remotely on controller	Integrator	X					X
0080	Read time upload request	Integrator	X					
0081	Read time upload reply	Controller		X				
0082	Set time	Integrator	X					X
0090	Multi-spindle status subscribe	Integrator			X			
0091	Multi-spindle status	Controller				X		
0092	Multi-spindle status acknowledge	Integrator					X	
0093	Multi-spindle status unsubscribe	Integrator			X			
0100	Multi-spindle result subscribe	Integrator			X			
0101	Multi-spindle result	Controller				X		

MID	Description	Sent by	Request message	Request reply message	Event subscription	Events	Event Acknowledge	Open Protocol command
0102	Multi-spindle result acknowledge	Integrator					X	
0103	Multi-spindle result unsubscribe	Integrator			X			
0104	Old Multi spindle result request	Integrator	X					
0105	Last Power MACS tightening result data subscribe	Integrator			X			
0106	Last Power MACS tightening result Station data	Controller				X		
0107	Last Power MACS tightening result Bolt data	Controller				X		
0108	Last Power MACS tightening result data acknowledge	Integrator					X	
0109	Last Power MACS tightening result data unsubscribe	Integrator			X			
0110	Display user text on compact	Integrator	X					X
0111	Display user text on graph	Integrator	X					X
0113	Flash green light on tool	Integrator	X					X
0120	Job line control info subscribe	Integrator			X			
0121	Job line control started	Controller				X		
0122	Job line control alert 1	Controller				X		
0123	Job line control alert 2	Controller				X		
0124	Job line control done	Controller				X		
0125	Job line control info acknowledge	Integrator					X	
0126	Job line control info unsubscribe	Integrator			X			
0127	Abort Job	Integrator	X					X
0128	Job batch increment	Integrator	X					X
0129	Job batch decrement	Integrator	X					X
0130	Job off	Integrator	X					X
0131	Set Job line control start	Integrator						X
0132	Set Job line control alert 1	Integrator						X
0133	Set Job line control alert 2	Integrator						X
0140	Execute dynamic Job request	Integrator	X					X
0150	Identifier download request	Integrator	X					X
0151	Multiple identifier and result parts subscribe	Integrator			X			
0152	Multiple identifier and result parts	Controller				X		
0153	Multiple identifiers and result parts acknowledge	Integrator					X	
0154	Multiple identifier and result parts unsubscribe	Integrator			X			
0155	Bypass identifier	Integrator	X					X
0156	Reset latest identifier	Integrator	X					X
0157	Reset all identifiers	Integrator	X					X
0200	Set external controlled relays	Integrator	X					X
0210	Status external monitored inputs subscribe	Integrator			X			

Message categories

MID	Description	Sent by	Request message	Request reply message	Event subscription	Events	Event Acknowledge	Open Protocol command
0211	Status external monitored inputs	Controller				X		
0212	Status external monitored inputs acknowledge	Integrator					X	
0213	Status external monitored inputs unsubscribe	Integrator			X			
0214	IO device status request	Integrator	X					
0215	IO device status reply	Controller		X				
0216	Relay function subscribe	Integrator			X			
0217	Relay function	Controller				X		
0218	Relay function acknowledge	Integrator					X	
0219	Relay function unsubscribe	Integrator			X			
0220	Digital input function subscribe	Integrator			X			
0221	Digital input function	Controller				X		
0222	Digital input function acknowledge	Integrator					X	
0223	Digital input function unsubscribe	Integrator			X			
0224	Set digital input function	Integrator	X					X
0225	Reset digital input function	Integrator	X					X
0240	User data download	Integrator						
0241	User data subscribe	Integrator			X			
0242	User data	Controller				X		
0243	User data acknowledge	Integrator					X	
0244	User data unsubscribe	Integrator			X			
0245	User data download with offset	Integrator						
0250	Selector socket info subscribe	Integrator			X			
0251	Selector socket info	Controller				X		
0252	Selector socket info acknowledge	Integrator					X	
0253	Selector socket info unsubscribe	Integrator			X			
0254	Selector control green lights	Integrator						X
0255	Selector control red lights	Integrator						X
0260	Tool Tag ID request	Integrator	X					
0261	Tool Tag ID subscribe	Integrator			X			
0262	Tool Tag ID	Controller		X		X		
0263	Tool Tag ID acknowledge	Integrator					X	
0264	Tool Tag ID unsubscribe	Integrator			X			
0265	External Tool tag ID and status	Integrator						X
0270	Controller reboot request	Integrator	X					X
0300	Histogram upload request	Integrator	X					
0301	Histogram upload reply	Controller		X				
0400	Automatic/Manual mode subscribe	Integrator			X			
0401	Automatic/Manual mode	Controller				X		
0402	Automatic/Manual mode acknowledge	Integrator					X	
0403	Automatic/Manual mode unsubscribe	Integrator			X			

MID	Description	Sent by	Request message	Request reply message	Event subscription	Events	Event Acknowledge	Open Protocol command
0410	Auto Disable settings request	Integrator	X					
0411	Auto Disable settings reply	Controller		X				
0420	Open protocol commands disabled subscribe	Integrator			X			
0421	Open protocol commands disabled	Controller				X		
0422	Open protocol commands disabled acknowledge	Integrator					X	
0423	Open protocol commands disabled unsubscribe	Integrator			X			
0500	Motor tuning result data subscribe	Integrator			X			
0501	Motor tuning result data	Controller		X				
0502	Motor tuning result data acknowledge	Integrator					X	
0503	Motor tuning result data unsubscribe	Integrator			X			
0504	Motor tuning request	Integrator						X
0700	Tightening data download status	Controller			X			
0701	Tool list upload reply	Controller		X				
0702	Tool Data upload reply with generic data	Controller		X				
0703	Set Calibration value request with generic data	Integrator						X
0704	Tool Data status reply with generic data	Controller		X				
0900	Result traces curve	Controller				X		
0901	Result traces curve plot data	Controller				X		
0902	Tightening Result DB Info Upload	Controller		X				
1000	Alarm	Controller				X		
1001	Alarm acknowledge	Integrator					X	
1201	Operation result Overall data	Controller		X				
1202	Operation result object data	Controller		X				
1203	Last Operation result data acknowledge	Integrator					X	
1601	Dynamic identifier message	Controller				X		
1602	Dynamic identifier data acknowledge	Integrator					X	
1900	Selector socket info	Controller				X		
1901	Selector socket control	Integrator	X					X
2100	Device command	Integrator						X
2500	Program data download	Integrator						X
2501	Tightening Program Message Upload	Controller		X				
2502	Password request	Controller	X					
2503	Password response	Integrator		X				
2504	Program Pset selection in Dynamic Job	Integrator						X
2505	Dynamic Pset Selection	Integrator						X
2506	Tightening Program Delete	Integrator	X					
2600	Mode ID upload request	Integrator	X					

MID	Description	Sent by	Request message	Request reply message	Event subscription	Events	Event Acknowledge	Open Protocol command
2601	Mode ID upload reply	Controller		X				
2602	Mode data upload request	Integrator	X					
2603	Mode data upload reply	Controller		X				
2604	Mode selected	Controller				X		
2605	Mode selected acknowledge	Integrator					X	
2606	Select Mode	Integrator	X					
8000 - 8100	Reserved for customer use	Integrator / Controller						
9000 - 9100	Reserved for customer use	Integrator / Controller						
9997	Link Level positive acknowledge	Integrator / Controller						
9998	Link Level negative acknowledge	Integrator / Controller						
9999	Keep alive open protocol communication	Integrator	X	X				

4.6 Implemented Messages from the list

Each Atlas Copco product that has implemented something from the list, has an release document that must be updated for all new releases of the product if there has been any changes done of the Open Protocol implementation. These documents shall tell the OP spec. release that the product is confirmed to, and all messages supported. See ref.

5 All messages

The following section describes all the messages in the Open Protocol.

5.1 Application Link Communication messages

5.1.1 MID 9998 Communication acknowledge error

This message is used in conjunction with the use of header sequence number.

Message sent by: Controller and Integrator:

This message is sent immediately after the message is received on application link level and if the check of the header is found to be wrong in any way.

The acknowledge substitute the use of NoAck flag and all subscription data special acknowledging.

For header description see section 2.2.2!

Table 8, MID 9998 Rev 1

Parameter	Byte	Value
MID number	21-24	MID number to which the acknowledgment error belongs to
Error code	25-28	Error code for the sent message, see Table 9

Table 9 Error code description

ID	Description
0001	Invalid length
0002	Invalid revision = Not equal to an ASCII number 0 to 99
0003	Invalid sequence number = Not next expected.
0004	Inconsistency of "Number of messages", "Message number"

5.1.2 MID 9997 Communication acknowledge

This message is used in conjunction with the use of header sequence number.

Message sent by: Controller and Integrator:

Is sent immediately after the message is received on application link level and if the check of the header is found to be ok.

The acknowledge substitute the use of NoAck flag and all subscription data special acknowledging

For header description see section 2.2.2!

Table 10, MID 9997 Rev 1

Parameter	Byte	Value
MID number	21-24	Acknowledged MID number

5.2 Application Communication messages

5.2.1 MID 0001 Application Communication start

This message enables the communication. The controller does not respond to any other command before this

Message sent by: Integrator
 Answers: **MID 0002 Communication start acknowledge** or
MID 0004 Command error, Client already connected or **MID revision unsupported**

Example: Communication start with call for **MID 0002 Communication start acknowledge** revision 3.

00200001003	NUL
-------------	-----

For header description see section 2.2.2!

Table 11 MID 0001 Revision 7

Parameter	Byte	Value
Optional Keep alive	21-22	01
	23	Telling the Open Protocol server that keep alive messages shall be used or not. 0=Use Keep alive (Keep alive is mandatory) 1=Ignore Keep alive (keep alive is optional)

Table 12 MID 0001 Additions for revision 8

Parameter	Byte	Value
Optional Tool lock at disconnection	24-25	02
	26	Telling the Open Protocol server that tool must be locked when communication is lost. 0=No tool lock 1=Tool lock
Optional early lock	27-28	03
	29-32	Time for when to lock the tool if suspecting that the communication is down. If activity is detected prior to closing the communication link the tool will be unlocked automatically. The time in seconds with one decimal is multiplied by 10 and sent as a positive 4-digit integer. Not used if 0 or space.

Note: Select a suitable keep alive interval to ensure the early lock restriction.

5.2.2 MID 0002 Application Communication start acknowledge

When accepting the communication start the controller sends as reply, a Communication start acknowledge. This message contains some basic information about the controller, such as cell ID, channel ID, and name.

Message sent by: Controller
Answer: None

Example, revision 1: The connected controller belongs to cell 1, the channel ID is 1 and the name is Airbag1

00570002	010001020103Airbag1	NUL
----------	---------------------	-----

For header description see section 2.2.2!

Table 13 MID 0002 Revision 1

Parameter	Byte	Value
Cell ID	21-22	01
	23-26	The cell ID is four bytes long specified by four ASCII digits. Range: 0000-9999.
Channel ID	27-28	02
	29-30	The channel ID is two bytes long specified by two ASCII digits. Range: 00-20.
Controller Name	31-32	03
	33-57	The controller name is 25 bytes long and specified by 25 ASCII characters.

Table 14 MID 0002 Additions for revision 2

Parameter	Byte	Value
Supplier code	58-59	04
	60-62	ACT (supplier code for Atlas Copco Tools) specified by three ASCII characters.

Table 15 MID 0002 Additions for revision 3

Parameter	Byte	Value
Open Protocol version	63-64	05
	65-83	Open Protocol version. 19 ASCII characters. This version mirrors the IMPLEMENTED version of the Open Protocol and is hence not the same as the version of the specification. This is caused by, for instance, the possibility of implementation done of only a subset of the protocol.
Controller software version	84-85	06
	86-104	The controller software version. 19 ASCII characters.
Tool software version	105-106	07
	107-125	The tool software version. 19 ASCII characters.

Table 16 MID 0002 Additions for revision 4

Parameter	Byte	Value
RBU Type	126-127	08
	128-151	The RBU Type. 24 ASCII characters.
Controller Serial Number	152-153	09
	154-163	The Controller Serial Number. 10 ASCII characters.

Table 17 MID 0002 Additions for revision 5

Parameter	Byte	Value
System type	164-165	10
	166-168	The system type of the controller. 3 ASCII digits Possible values are: 000 = System type not set 001 = Power Focus 4000 002 = Power MACS 4000 003 = Power Focus 6000 004 = Micro Torque Focus 6000
System subtype	169-170	11
	171-173	The system subtype. 3 ASCII digits If no subtype exists it will be set to 000 For a Power Focus 4000 and PF 6000 system the valid subtypes are: 001 = a normal tightening system For a Power MACS 4000 system the valid subtypes are: 001 = a normal tightening system 002 = a system running presses instead of spindles.

Table 18 MID 0002 Additions for revision 6

Parameter	Byte	Value
Sequence number support	174-175	12
	176	Flag sequence number handling supported if = 1
Linking handling support	177-178	13
	179	Flag linking functionality handling supported if = 1.
Station Id PF6000 Cell Id PF4000	180-181	14
	182-191	The station id/Cell Id is a unique id for each station. 10 ASCII digits. Max 4294967295
Station Name PF 6000 Cell Name PF 4000	192-193	15
	194-218	The station/Cell name is 25 bytes long and specified by 25 ASCII characters.
Client Id	219-220	16
	221	The Connection Client ID. 1 byte 1 ASCII digit. Used at several connections towards a one channel controller.

Table 19 MID 0002 Additions for revision 7

Parameter	Byte	Value
Optional Keep alive	222-223	17
	224	Telling if optional keep alive will be used or not 0=Use Keep alive (Keep alive is mandatory) 1=Ignore Keep alive (keep alive is optional)

Table 20 MID 0002 Additions for revision 8

Parameter	Byte	Value
Optional Tool lock at disconnection	225-226	18
	227	Telling if optional tool lock when loosing communication is used. 0=No tool lock 1=Tool lock
Optional early lock	228-229	19
	230-233	Time when tool will lock if suspecting that the communication is down. Any activity is detected prior to closing the communication link will unlock the tool automatically. The time in seconds with one decimal is multiplied by 10 and sent as a positive 4-digit integer. Not used if 0 or space.

Note: Select a suitable keep alive interval to ensure the early lock restriction.

5.2.3 MID 0003 Application Communication stop

This message disables the communication. The controller will stop to respond to any commands except for **MID 0001 Communication start** after receiving this command.

Message sent by: Integrator
 Answer: **MID 0005 Command accepted**

For header description see section 2.2.2!

5.2.4 MID 0004 Application Communication negative acknowledge

This message is used by the controller when a request, command or subscription for any reason has not been performed. The data field contains the message ID of the message request that failed as well as an error code.

It can also be used by the integrator to acknowledge received subscribed data/events upload and will then do all the special subscription data acknowledges obsolete.

When using the communication acknowledgement of MID 9997 and MID 9998 together with sequence numbering this is an application level message only.

For detailed description of use of this message, please look at each Request, Subscription or Command MID's description.

Message sent by: Controller:
Answer: None

Example: The request **MID 0018 Select parameter set** failed, the parameter set number was not present in the controller.

00260004	001802NUL
----------	-----------

For header description see section 2.2.2!

Table 21 MID 0004 Rev 1

Parameter	Byte	Value
MID number	21-24	MID number
Error code	25-26	Error code for the sent message, see Table 23. 00 to 99

Table 22 MID 0004 Rev 2

Parameter	Byte	Value
MID number	21-24	MID number
Error code	25-27	Error code for the sent message, see Table 23. 000 to 999

Table 23 Error code description

ID	Description
00	No Error
01	Invalid data
02	Parameter set ID not present
03	Parameter set can not be set.
04	Parameter set not running
06	VIN upload subscription already exists
07	VIN upload subscription does not exist
08	VIN input source not granted
09	Last tightening result subscription already exists

All messages

ID	Description
10	Last tightening result subscription does not exist
11	Alarm subscription already exists
12	Alarm subscription does not exist
13	Parameter set selection subscription already exists
14	Parameter set selection subscription does not exist
15	Tightening ID requested not found
16	Connection rejected protocol busy
17	Job ID not present
18	Job info subscription already exists
19	Job info subscription does not exist
20	Job can not be set
21	Job not running
22	Not possible to execute dynamic Job request
23	Job batch decrement failed
24	Not possible to create Pset
25	Programming control not granted
26	Wrong tool type to Pset download connected
27	Tool is inaccessible
28	Job abortion is in progress
29	Tool does not exist
30	Controller is not a sync Master/station controller
31	Multi-spindle status subscription already exists
32	Multi-spindle status subscription does not exist
33	Multi-spindle result subscription already exists
34	Multi-spindle result subscription does not exist
35	Other master client already connected
36	Lock type not supported
40	Job line control info subscription already exists
41	Job line control info subscription does not exist
42	Identifier input source not granted
43	Multiple identifiers work order subscription already exists
44	Multiple identifiers work order subscription does not exist
50	Status external monitored inputs subscription already exists
51	Status external monitored inputs subscription does not exist
52	IO device not connected
53	Faulty IO device ID
54	Tool Tag ID unknown
55	Tool Tag ID subscription already exists
56	Tool Tag ID subscription does not exist
57	Tool Motor tuning failed
58	No alarm present
59	Tool currently in use

ID	Description
60	No histogram available
61	Pairing failed
62	Pairing denied
63	Pairing or Pairing abortion attempt on wrong tooltype
64	Pairing abortion denied
65	Pairing abortion failed
66	Pairing disconnection failed
67	Pairing in progress or already done
68	Pairing denied. No Program Control
69	Unsupported extra data revision
70	Calibration failed
71	Subscription already exists
72	Subscription does not exist
73	Subscribed MID unsupported, -answer if trying to subscribe on a non-existing MID
74	Subscribed MID Revision unsupported, -answer if trying to subscribe on unsupported MID Revision.
75	Requested MID unsupported -answer if trying to request on a non-existing MID
76	Requested MID Revision unsupported -response when trying to request unsupported MID Revision
77	Requested on specific data not supported -response when trying to request data that is not supported
78	Subscription on specific data not supported -answer if trying to subscribe for unsupported data
79	Command failed
80	Audi emergency status subscription exists
81	Audi emergency status subscription does not exist
82	Automatic/Manual mode subscribe already exist
83	Automatic/Manual mode subscribe does not exist
84	The relay function subscription already exists
85	The relay function subscription does not exist
86	The selector socket info subscription already exist
87	The selector socket info subscription does not exist
88	The digin info subscription already exist
89	The digin info subscription does not exist
90	Lock at batch done subscription already exist
91	Lock at batch done subscription does not exist
92	Open protocol commands disabled
93	Open protocol commands disabled subscription already exists
94	Open protocol commands disabled subscription does not exist
95	Reject request, Power MACS is in manual mode
96	Reject connection, Client already connected
97	MID revision unsupported
98	Controller internal request timeout

All messages

ID	Description
99	Unknown MID
100	Illegal PID
101	Tightening in progress
102	Delete of object not possible
103	Illegal program ID
102	Illegal node type
...	
900 to 999	Reserved for application specific error codes

5.2.5 MID 0005 Application Communication positive acknowledge

This message is used by the controller to confirm that the latest command, request or subscription sent by the integrator was accepted. The data field contains the MID of the request accepted if the special MIDs for request or subscription are used.

It can also be used by the integrator to acknowledge received subscribed data/events upload and will then do all the special subscription data acknowledges obsolete.

When using the communication acknowledgement of MID 9997 and MID 9998 together with sequence numbering this is an application level message only.

For detailed description of use of this message, please look at each Request, Subscription or Command MIDs description.

Message sent by: Controller.
Answer: None.

Example: The request **MID 0018 Select parameter set** is accepted.

00240005	0018NUL
----------	---------

For header description see section 2.2.2!

Table 24 MID 0005 Rev 1

Parameter	Byte	Value
MID number accepted.	21-24	Four ASCII digits. The requested MID number as the response of MID 0008 and MID 0009

5.2.6 MID 0006 Application data message request

Do a request for data. This message is used for ALL request handling.

When used it substitutes the use of all MID special request messages.

NOTE! The Header Revision field is the revision of the MID 0006 itself NOT the revision of the data MID that is wanted to be uploaded.

Message sent by: Integrator

Answer: **MID Requested for or
MID 0004 Command error. Error described at each MID description.**

For header description see section 2.2.2!

Data field, MID 0006

Table 25 MID 0006, revision 1

Parameter	Size [byte]	Data type	Description
Requested MID	4	UI	The data MID ID that is requested. Can be used for ALL request handling.
Wanted revision	3	UI	The revision of the MID that is requested for.
Extra data length	2	UI	The length of the extra data field.
Extra data	Value of "Extra data length"	UI	The "Extra data" definition can be found where the MID to request for is defined.

5.2.7 MID 0008 Application data message subscription

Start a subscription of data. This message is used for ALL subscription handling.

When used it substitutes the use of all MID special subscription messages.

NOTE! The Header Revision field is the revision of the MID 0008 itself NOT the revision of the data MID that is wanted to be subscribed for.

Message sent by: Integrator

Answer: MID 0005 Command accepted or
MID 0004 Command error, MID revision unsupported or Invalid data code

Example: The request of a subscription for MID 900.

006800080010	0900001390	020010020NUL
--------------	------------	--------------

For header description see section 2.2.2!

Data field, MID 0008

Table 26 MID 0008, revision 1

Parameter	Byte [Size]	Data type	Description
Subscription MID	21-24 [4]	UI	The data MID ID to be subscribed for. Can be used for ALL subscription handling. ² For example Trace Data = 0900, Mode Selected = 2604, Overall Results = 1201, Last Operation result = 1202
Wanted revision	25-27 [3]	UI	The revision of the MID to subscribe for
Extra data length	28-29 [2]	UI	The length of the extra data field.
Extra data	30-xx [Value of "Extra data length"]	UI	The "Extra data" definition can be found where the MID to subscribe to is defined.

²Different controller Documents on specific controller support different MID this is described in chapter 0 Reference.

5.2.8 MID 0009 Application Data Message unsubscribe

Unsubscribe the data. This message is used for ALL unsubscribe.

When used it substitutes the use of all MID special subscription messages.

NOTE! The Header Revision field is the revision of the MID 0009 itself NOT the revision of the data MID that is wanted to be subscribed for.

Message sent by: Integrator

Answer: MID 0005 Command accepted or

MID 0004 Command error, MID revision unsupported or Invalid data code

For header description see section 2.2.2!

Data field, MID 0009

Table 27 MID 0009, revision 1

Parameter	Byte [size]	Data type	Description
Unsubscription MID	21-24 [4]	UI	The data MID ID to be unsubscribed for. Can be used for ALL subscription handling. For example Mode Selected = 2604, Overall Results = 1201, Last Operation result = 1202
Extra data revision	25-27 [3]	UI	The revision of the MIDs Extra data that is subscribed for. This is needed so that the Controller can determine the revision of the extra data in the unsubscription.
Extra data length	28-29 [2]	UI	The length of the extra data field.
Extra data	30-xx [Value of "Extra data length"]	UI	The "Extra data" definition can be found where the MID to unsubscribe is defined.

5.3 Application Parameter Set Messages

5.3.1 MID 0010 Parameter set ID upload request

A request to get the valid parameter set IDs from the controller.

Message sent by: Integrator
 Answer: MID 0011 Parameter set ID upload reply

For header description see section 2.2.2!

5.3.2 MID 0011 Parameter set ID upload reply

The transmission of all the valid parameter set IDs of the controller. In the revision 000-001 the data field contains the number of valid parameter sets currently present in the controller, and the ID of each parameter set present. In revision 2 is the number of stages on each Pset/Mset added.

Message sent by: Controller
 Answer: None

Example: parameter set 1 and 2 are present in the controller.

00290011	002001002NUL
----------	--------------

For header description see section 2.2.2!

Table 28 MID 0011 Rev 1

Parameter	Byte	Value
The number of parameter sets/multistage in the controller	21-23	Three ASCII digits. Range: 000-999
The ID of each parameter set/multistage present	24-(23+Npset*3)	Three ASCII digits for each parameter se/multistage

Table 29 MID 0011 additions for revision 2

Parameter	Byte	Value
The number of cycles = stages for each Pset/Multistage ID	(24+Npset*3)-(23+Npset*5)	Two ASCII digits. Range: 00-99 For a single Pset: 1, 2 or more stages. For a Multistage: Numb. Of Multistage stages (Psets) * (Number of Pset stages) Ex. 5 Multistage stages and 1 pset with 1 stage and four Psets with two stages each, will be (1*1 + 4 *2) = 9 stages in total.

Table 30 MID 0011 additions for revision 3

Parameter	Byte	Value
Type of Program	(24+Npset*5)- (23+Npset*9)	Four ASCII character for strings: "Mset" or "Pset" telling if Pset or Multistage

Table 31 MID 0011 additions for revision 4

Parameter	Byte	Value
Date of last change in parameter set setting	(24+Npset*9)- (23+Npset*28)	19 ASCII characters YYYY-MM-DD:HH:MM:SS

5.3.3 MID 0012 Parameter set data upload request

Request to upload parameter set data from the controller.

Message sent by: Integrator

Answer: **MID 0013 Parameter set data upload reply, or
MID 0004 Command error, Parameter set not present**

Example: Request to upload parameter set data for parameter set 1.

00230012	001NUL
----------	--------

For header description see section 2.2.2!

Table 32 MID 0012 Rev 1, Rev 2 and Rev 5

Parameter	Byte	Value
Parameter set ID	21-23	Three ASCII digits. Range: 000-999

Table 33 MID 0012 Rev 3 and Rev 4

Parameter	Byte	Value
Pset file version	24-31	00000000 (special usage see Toyota appendix)

5.3.4 MID 0013 Parameter set data upload reply

Upload of parameter set data reply.

- Message sent by: Controller
- Answer: None

Example: Upload parameter set data for parameter set 1 called Airbag 1.

01040013	0100102Airbag1	031040305001200
0600150007001400080036009007201000480NUL		

For header description see section 2.2.2!

Table 34 MID 0013 Revision 1

Parameter	Byte	Value
Parameter set ID	21-22	01
	23-25	Three ASCII digits, range 000-999
Parameter set name	26-27	02
	28-52	25 ASCII characters. Right padded with space if name is less than 25 characters.
Rotation direction	53-54	03
	55	1=CW, 2=CCW
Batch size	56-57	04
	58-59	2 ASCII digits, range 00-99
Torque min	60-61	05
	62-67	The torque min limit is multiplied by 100 and sent as an integer (2 decimals truncated). It is six bytes long and is specified by six ASCII digits.
Torque max	68-69	06
	70-75	The torque max limit is multiplied by 100 and sent as an integer (2 decimals truncated). It is six bytes long and is specified by six ASCII digits.
Torque final target	76-77	07
	78-83	The torque final target is multiplied by 100 and sent as an integer (2 decimals truncated). It is six bytes long and is specified by six ASCII digits.
Angle min	84-85	08
	86-90	The angle min value is five bytes long and is specified by five ASCII digits. Range: 00000-99999.
Angle max	91-92	09
	93-97	The angle max value is five bytes long and is specified by five ASCII digits. Range: 00000-99999.
Final Angle Target	98-99	10
	100-104	The target angle is specified in degrees. 5 ASCII digits. Range: 00000-99999.

Table 35 MID 0013 additions for revision 2

Parameter	Byte	Value
First Target	105-106	11
	107-112	The torque first target is multiplied by 100 and sent as an integer (2 decimals truncated). It is six bytes long and is specified by six ASCII digits.
Start final angle	113-114	12
	115-120	The start final angle is the torque to reach the snug level. The start final angle is multiplied by 100 and sent as an integer (2 decimals truncated). It is six bytes long and is specified by six ASCII digits.

Table 36 MID 0013 Revision 3 and 4

Parameter	Byte	Value
Pset file version	21-28	N/A
Parameter set data	29-variable	See Toyota appendix

Important note: MID 0013 Revision 5 is continuation of MID 0013 revision 2.

Table 37 MID 0013 Revision 5, Continuation of revision 2

Parameter	Byte	Value
Date of last change in parameter set setting	121-122	13
	123-141	19 ASCII characters, YYYY-MM-DD:HH:MM:SS

5.3.5 MID 0014 Parameter set selected subscribe

A subscription for the parameter set selection. Each time a new parameter set is selected the **MID 0015 Parameter set selected** is sent to the integrator. Note that the immediate response is **MID 0005 Command accepted** and **MID 0015 Parameter set selected** with the current parameter set number selected.

Message sent by: Integrator

Answer: **MID 0005 Command accepted** and **MID 0015 Parameter set selected**

For header description see section 2.2.2!

5.3.6 MID 0015 Parameter set selected

A new parameter set is selected in the controller. The message includes the ID of the parameter set selected as well as the date and time of the last change in the parameter set settings. This message is also sent as an immediate response to **MID 0014 Parameter set selected subscribe**.

Message sent by: Controller
 Answer: **MID 0016 New parameter set selected acknowledge**

For header description see section 2.2.2!

NOTE: The values used for “Parameter set ID” may be configurable by controller setting, read controller specific appendix for clarification.

Example: “Parameter set ID” can be index for the tightening program or the identifier number for the tightening program found in the tightening menu.

Table 38 MID 0015 Revision 1

Parameter	Byte	Value
Parameter set ID	21-23	Three ASCII digits, range 000-999
Date of last change in parameter set setting	24-42	19 ASCII characters. YYYY-MM-DD:HH:MM:SS

Table 39 MID 0015 Revision 2

Parameter	Byte	Value
Parameter set ID	21-22	01
	23-25	Three ASCII digits, range 000-999
Parameter set name	26-27	02
	28-52	25 ASCII characters. Right padded with space if name is less than 25 characters.
	53-54	03
Date of last change in parameter set setting	55-73	19 ASCII characters. YYYY-MM-DD:HH:MM:SS
Rotation direction	74-75	04
	76	1=CW, 2=CCW
Batch size	77-78	05
	79-80	2 ASCII digits, range 00-99
Torque min	81-82	06
	83-88	The torque min limit is multiplied by 100 and sent as an integer (2 decimals truncated). It is six bytes long and is specified by six ASCII digits.
Torque max	89-90	07
	91-96	The torque max limit is multiplied by 100 and sent as an integer (2 decimals truncated). It is six bytes long and is specified by six ASCII digits.

All messages

Parameter	Byte	Value
Torque final target	97-98	08
	99-104	The torque final target is multiplied by 100 and sent as an integer (2 decimals truncated). It is six bytes long and is specified by six ASCII digits.
Angle min	105-106	09
	107-111	The angle min value is five bytes long and is specified by five ASCII digits. Range: 00000-99999.
Angle max	111-112	10
	113-117	The angle max value is five bytes long and is specified by five ASCII digits. Range: 00000-99999.
Final Angle Target	118-119	11
	120-124	The target angle is specified in degrees. 5 ASCII digits. Range: 00000-99999.
First Target	125-126	12
	127-132	The torque first target is multiplied by 100 and sent as an integer (2 decimals truncated). It is six bytes long and is specified by six ASCII digits.
Start final angle	133-134	13
	135-141	The start final angle is the torque to reach the snug level. The start final angle is multiplied by 100 and sent as an integer (2 decimals truncated). It is six bytes long and is specified by six ASCII digits.

Table 40 MID 0015 Additions for revision 3

Parameter	Byte	Value
Selected Identifier Number	142-143	14
	144-147	The identifier number used to select the program is four bytes long and specified by four ASCII digits. Range: 0000-9999.
Joint ID	148-149	15
	150-174	25 ASCII characters. Right padded with space if Joint ID is less than 25 characters.

5.3.7 MID 0016 Parameter set selected acknowledge

Acknowledgement for a new parameter set selected.

Message sent by: Integrator
 Answer: None

For header description see section 2.2.2!

5.3.8 MID 0017 Parameter set selected unsubscribe

Reset the subscription for the parameter set selection.

Message sent by: Integrator
 Answer: **MID 0005 Command accepted** or
MID 0004 Command error, Parameter set subscription does not exist

For header description see section 2.2.2!

5.3.9 MID 0018 Select Parameter set

Select a parameter set.

Message sent by: Integrator
 Answer: **MID 0005 Command accepted** or
MID 0004 Command error, Parameter set can not be set

Note!

For an PF3000/4000 with Open protocol version 1.2.1 or later, configured with selector accessory configured with "confirm" or "confirm with Ack" the answer will be Command accepted if it is possible for the operator to select the Pset via choosing the correct socket on the selector.

The Pset will then be automatically selected when the operator chooses the correct socket from the selector. Subscription of the currently selected Pset via MID 0014 will show when the operator has selected the correct Pset.

For header description see section 2.2.2!

Table 40 MID 0018 Revision 1

Parameter	Byte	Value
Parameter set ID	21-23	Three ASCII digits, range 000-999

5.3.10 MID 2504 Select Parameter set, Dynamic Job Included

Select a parameter set.

Message sent by: Integrator
 Answer: **MID 0005 Command accepted** or
MID 0004 Command error, Dynamic Job cannot be created, non-existing pset

A default dynamic Job shall be created with only the selected Pset in the component list.

For header description see section 2.2.2!

Table 41 MID 2504 Revision 1

Parameter	Byte	Value
Parameter set ID	21-23	Three ASCII digits, range 000-999

5.3.11 MID 2505 Select Parameter set dynamically.

Message sent by: Integrator
 Answer: **MID 0005 Command accepted** or
MID 0004 Command error, Dynamic Pset cannot be created, non-existing pset

A dynamic pset is created from a preexisting Pset in the Controller and selected for tightenings. The message can substitute Pset selection, Set Identifier, Reset All Identifier, Reset Latest Identifier, Set Batch Size, Disable Tool and Enable Tool.

For header description see section 2.2.2!

Parameter	Size [byte]	Data type	Description
Parameter set ID	3	UI	Three ASCII digits, range 000-999
Number of parameter data fields	3	UI	The number of variable data fields. Number of parameters for the selected preexisting Pset to be changed.
Data fields	Vary		This section is repeated “Number of data fields” times. If Number of data fields = 000, this section is not sent. . The structure is of variable parameter type, see Variable Data Field Use

Examples of Pset parameters PIDs that can be included for change in the preexisting Pset:

PID 00100, Batch size

PID 00010-00020 Identifiers

PID 00031 Identifier treatments

PID 02002, Torque upper limit

PID 02003, Torque lower limit

A check for allowed PIDs to be included in this message should be done for each controller type.

5.3.12 MID 0019 Set Parameter set batch size

This message gives the possibility to set the batch size of a parameter set at run time.

Message sent by: Integrator
 Answer: MID 0005 Command accepted or
 MID 0004 Command error, Invalid data

For header description see section 2.2.2!

Table 42 MID 0019 Revision 1

Parameter	Byte	Value
Parameter set ID	21-23	Three ASCII digits, range 000-999
Batch size	24-25	Two ASCII digits, range 00-99

Table 43 MID 0019 Revision 2

Parameter	Byte	Value
Parameter set ID	21-23	Three ASCII digits, range 000-999
Batch size	24-27	Four ASCII digits, range 0000-9999

5.3.13 MID 0020 Reset Parameter set batch counter

This message gives the possibility to reset the batch counter of the running parameter set, at run time.

For PF4000 the Pset Batch must be configured to Ethernet/Serial.

Message sent by: Integrator
Answer: **MID 0005 Command accepted** or
MID 0004 Command error, Invalid data, or Parameter set not running

For header description see section 2.2.2!

Table 44 MID 0020 Revision 1

Parameter	Byte	Value
Parameter set ID	21-23	Three ASCII digits, range 000-999

5.3.14 MID 0021 Lock at batch done subscribe

A subscription for the Lock at batch done relay status.

Message sent by: Integrator
Answer: **MID 0005 Command accepted** or **MID 0004 Command error**
Message: **MID 0022** relay status immediately after **MID 0005** Command accepted

For header description see section 2.2.2!

5.3.15 MID 0022 Lock at batch done upload

This message gives the relay status for Lock at batch done.

Message sent by: Controller
 Answer: MID 0023 Lock at batch done upload Ack

For header description see section 2.2.2!

Table 45 MID 0022 Revision 1

Parameter	Byte	Value
Relay status	21	One ASCII digit, range 0-1

5.3.16 MID 0023 Lock at batch done upload Acknowledge

This message is an acknowledge to MID 0022.

Message sent by: Integrator
 Answer: MID 0005 Command accepted

For header description see section 2.2.2!

5.3.17 MID 0024 Lock at batch done unsubscribe

Reset the subscription for Lock at batch done.

Message sent by: Integrator
 Answer: MID 0005 Command accepted or MID 0004 Command error

For header description see section 2.2.2!

5.3.18 MID 0025 Parameter user set download request

This message is reserved for Toyota, see Toyota Appendix.

5.3.19 MID 2500 Tightening Program Message download

This MID contains the program parameter data, and is used for download and CREATION of a new program or UPDATING of an already existing program in the PF controller.

Message sent by: Integrator

Answer version 1: Received message acknowledge by Controller with **Link Level** MID 9997 if OK, MID 9998 if error if sequence number in the header $\neq 0$. After program has been written in the PF database the **Application Level** MID 0005, MID 0004 Acknowledge will be sent.

Answer version 2: If sequence number isn't used the **Application Level** MID 0005, MID 0004 Acknowledge shall be used only.

How this is supported in each controller see in each controllers implementation document. The recommendation is to always use the Link level acknowledge method if possible.

5.3.19.1 Data field header MID 2500

The data for a Tightening program is represented in a tree structure. The number of branches and depths depend on the actual tightening program and the system type.

Each node in the tree are represented in the same way. The node have a "Node type" and a varying number of paramters. It also specifies the number of children it has.

The principal layout of one node is like this in revision 1:

```
Node Type
Number of parameters
Parameters (zero or more)
Number of children
```

The principal layout of the telegram is like this in revision 1:

```
Node Type
Number of parameters
Parameters (zero or more)
Number of children
    Node Type
    Number of parameters
    Parameters (zero or more)
    Number of children
        Node Type
        Number of parameters
        Parameters (zero or more)
        Number of children
            ...
```

Consider this example tree (that could be a representation of a tightening program):

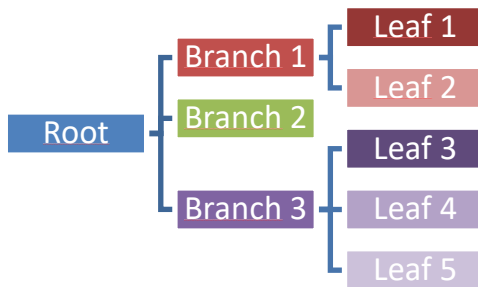

In a telegram it will be sent like this (ignoring the parameters):

Node Type "Root"	<i>Root</i>
Number of children "3"	
Node Type "Branch"	<i>Branch 1</i>
Number of children "2"	
Node Type "Leaf"	<i>Leaf 1</i>
Number of children "0"	
Node Type "Leaf"	<i>Leaf 2</i>
Number of children "0"	
Node Type "Branch"	<i>Branch 2</i>
Number of children "0"	
Node Type "Branch"	<i>Branch 3</i>
Number of children "3"	
Node Type "Leaf"	<i>Leaf 3</i>
Number of children "0"	
Node Type "Leaf"	<i>Leaf 4</i>
Number of children "0"	
Node Type "Leaf"	<i>Leaf 5</i>
Number of children "0"	

The principal layout of one node is like this in revision 2:

Node Type
Number of parameters
Parameters (zero or more)
Number of children
JSON length
JSON string

The principal layout of the telegram is like this in revision 2:

Node Type
Number of parameters
Parameters (zero or more)
Number of children
JSON length
JSON string
 Node Type
 Number of parameters
 Parameters (zero or more)
 Number of children
 JSON length
 JSON string
 Node Type
 Number of parameters
 Parameters (zero or more)
 Number of children
 JSON length
 JSON string
 ...

5.3.19.2 Detailed specification for one node

Table 46 Node specification revision 1

Parameter	Size [byte]	Data type	Description																												
Node type	3	UI	The type of the node, see Table 49.																												
Number of parameter data fields	3	UI	The number of variable data fields in this node																												
Data fields	Vary		This section is repeated “Number of data fields” times. If Number of data fields = 000, this section is not sent. . The structure is of variable parameter type, see Variable Data Field Use																												
			<table border="1"> <thead> <tr> <th>Parameter</th> <th>Size [byte]</th> <th>Data type</th> <th>Description</th> </tr> </thead> <tbody> <tr> <td>Parameter id (PID).</td> <td>5</td> <td>UI</td> <td>The available PID’s may vary depending on the system type.</td> </tr> <tr> <td>Length</td> <td>3</td> <td>UI</td> <td>Length of data value.</td> </tr> <tr> <td>Data Type</td> <td>2</td> <td>UI</td> <td>Data type of the data value.</td> </tr> <tr> <td>Unit</td> <td>3</td> <td>UI</td> <td>Unit of the data.</td> </tr> <tr> <td>Step no.</td> <td>4</td> <td>UI</td> <td>The step number. Sent as 0000 if not relevant</td> </tr> <tr> <td>Data value</td> <td>Length</td> <td>UI</td> <td>The data value.</td> </tr> </tbody> </table>	Parameter	Size [byte]	Data type	Description	Parameter id (PID).	5	UI	The available PID’s may vary depending on the system type.	Length	3	UI	Length of data value.	Data Type	2	UI	Data type of the data value.	Unit	3	UI	Unit of the data.	Step no.	4	UI	The step number. Sent as 0000 if not relevant	Data value	Length	UI	The data value.
Parameter	Size [byte]	Data type	Description																												
Parameter id (PID).	5	UI	The available PID’s may vary depending on the system type.																												
Length	3	UI	Length of data value.																												
Data Type	2	UI	Data type of the data value.																												
Unit	3	UI	Unit of the data.																												
Step no.	4	UI	The step number. Sent as 0000 if not relevant																												
Data value	Length	UI	The data value.																												
Number of children	2	UI																													

Table 47 Node specification for revision 2

Parameter	Size [byte]	Data type	Description																												
Node type	3	UI	The type of the node, see Table 49.																												
Number of parameter data fields	3	UI	The number of variable data fields in this node																												
Data fields	Vary		This section is repeated “Number of data fields” times. If Number of data fields = 000, this section is not sent. . The structure is of variable parameter type, see Variable Data Field Use																												
			<table border="1"> <thead> <tr> <th>Parameter</th> <th>Size [byte]</th> <th>Data type</th> <th>Description</th> </tr> </thead> <tbody> <tr> <td>Parameter id (PID).</td> <td>5</td> <td>UI</td> <td>The available PID’s may vary depending on the system type.</td> </tr> <tr> <td>Length</td> <td>3</td> <td>UI</td> <td>Length of data value.</td> </tr> <tr> <td>Data Type</td> <td>2</td> <td>UI</td> <td>Data type of the data value.</td> </tr> <tr> <td>Unit</td> <td>3</td> <td>UI</td> <td>Unit of the data.</td> </tr> <tr> <td>Step no.</td> <td>4</td> <td>UI</td> <td>The step number. Sent as 0000 if not relevant</td> </tr> <tr> <td>Data value</td> <td>Length</td> <td>UI</td> <td>The data value.</td> </tr> </tbody> </table>	Parameter	Size [byte]	Data type	Description	Parameter id (PID).	5	UI	The available PID’s may vary depending on the system type.	Length	3	UI	Length of data value.	Data Type	2	UI	Data type of the data value.	Unit	3	UI	Unit of the data.	Step no.	4	UI	The step number. Sent as 0000 if not relevant	Data value	Length	UI	The data value.
Parameter	Size [byte]	Data type	Description																												
Parameter id (PID).	5	UI	The available PID’s may vary depending on the system type.																												
Length	3	UI	Length of data value.																												
Data Type	2	UI	Data type of the data value.																												
Unit	3	UI	Unit of the data.																												
Step no.	4	UI	The step number. Sent as 0000 if not relevant																												
Data value	Length	UI	The data value.																												
Number of children	2	UI	Note: This is the number of children for the MID 2500 node and will hence normally be 0 for this MID 2500 revision as the JSON part will include all sub levels.																												
JSON string length	4	UI	The length of the JSON string in this node. The length cannot be longer than the total allowed MID length minus additional data from header, variable data and node information of all nodes.																												
JSON string data part	JSON string length	String	This field contains a JSON string. The device defines the actual data, please consult the device documentation. If JSON string length is 0000, this section is not sent (empty).																												

Table 48 Node specification for revision 3

Parameter	Size [byte]	Data type	Description																												
Node type	3	UI	The type of the node, see Table 49.																												
Number of parameter data fields	3	UI	The number of variable data fields in this node																												
Data fields	Vary		This section is repeated “Number of data fields” times. If Number of data fields = 000, this section is not sent. . The structure is of variable parameter type, see Variable Data Field Use																												
			<table border="1"> <thead> <tr> <th>Parameter</th> <th>Size [byte]</th> <th>Data type</th> <th>Description</th> </tr> </thead> <tbody> <tr> <td>Parameter id (PID).</td> <td>5</td> <td>UI</td> <td>The available PID’s may vary depending on the system type.</td> </tr> <tr> <td>Length</td> <td>3</td> <td>UI</td> <td>Length of data value.</td> </tr> <tr> <td>Data Type</td> <td>2</td> <td>UI</td> <td>Data type of the data value.</td> </tr> <tr> <td>Unit</td> <td>3</td> <td>UI</td> <td>Unit of the data.</td> </tr> <tr> <td>Step no.</td> <td>4</td> <td>UI</td> <td>The step number. Sent as 0000 if not relevant</td> </tr> <tr> <td>Data value</td> <td>Length</td> <td>UI</td> <td>The data value.</td> </tr> </tbody> </table>	Parameter	Size [byte]	Data type	Description	Parameter id (PID).	5	UI	The available PID’s may vary depending on the system type.	Length	3	UI	Length of data value.	Data Type	2	UI	Data type of the data value.	Unit	3	UI	Unit of the data.	Step no.	4	UI	The step number. Sent as 0000 if not relevant	Data value	Length	UI	The data value.
Parameter	Size [byte]	Data type	Description																												
Parameter id (PID).	5	UI	The available PID’s may vary depending on the system type.																												
Length	3	UI	Length of data value.																												
Data Type	2	UI	Data type of the data value.																												
Unit	3	UI	Unit of the data.																												
Step no.	4	UI	The step number. Sent as 0000 if not relevant																												
Data value	Length	UI	The data value.																												
Number of children	2	UI	Note: This is the number of children for the MID 2500 node and will hence normally be 0 for this MID 2500 revision as the JSON part will include all sub levels.																												
JSON string length	6	UI	The length of the JSON string in this node. The length cannot be longer than the total allowed MID length minus additional data from header, variable data and node information of all nodes. Note: When the length of the JSON string is long the message linking functionality must be used.																												
JSON string data part	JSON string length	String	This field contains a JSON string. The device defines the actual data, please consult the device documentation. If JSON string length is 0000, this section is not sent (empty).																												

5.3.19.3 Available node types

Format: 3 ASCII digits

Table 49 Available node types

Value sent in telegram	Unit
001	Parameter Set
002	Multistage.
003	Job.
100	Tightening program
101	Tightening Step
102	Restriction
103	Check
104	Speed ramp
105	Monitoring
201	Multistep tightening program

5.3.19.4 Example parameters for PF4000

Below is an example on parameters that could be sent for a Parameter Set node type.

The expression "Parameter Set" is exclusively used in the PF4000 controller.

OBS! The Tool Type (PID = 01203) is a required parameter to send at download. It must match the tool connected and thereby the Pset aimed for that tool.

OBS! The Time of Last Change (PID 01003) is only to be sent in the upload MID = 02501.

Table 50 Example parameters for PF4000

Parameter id (PID)	Name	Description
01001	Stage/Pset name	The expression Stage is used as a synonym to Parameter Set. A set name of the Stage/Parameter Set.
01000	Tightening program Number	The number or index of the tightening program or Pset that made the tightening (Pset ID)

Parameter id (PID)	Name	Description
01203	Tool Type	0=No Tool, 1=S-tool, 2=DS-tool, 3=Ref. transducer, 4=ST-tool, 5=EP-tool, 6=ETX-tool, 7=SL-tool, 8=DL-tool, 9=IRC Offline, 10=STB-tool, 11=QST-tool, 12=STT-tool, 13=Stwrench, 14 = ES-tool, 15 = ESB, 16 = SB, 17 = SB+, 18 = PST-tool, 19 = STR-tool, 20 = ETD M, 21 = ETD MC, 22 = ETD MT, 23 = QMC, 24 = QMT, 25 = BCV-RE, 26 = BCP-RE, 27 = E-LIT, 28 = ISB, 29 = ITB, 30 = ITP, 31 = Qshield-C, 32 = DeltaWrench, 33 = STRWrench
01002	Tightening program Strategy	The overall strategy used in the tightening program. Possible strategies are: 1=Torque control 2=Torque control / angle monitoring 3=Torque control / angle control AND 4=Angle control / torque monitoring 5=DS control 6=DS control torque monitoring 7=Reverse angle 8=Reverse torque 9=Click wrench 10=Rotate spindle forward 11=Torque control angle control OR 12=Rotate spindle reverse 13=Home position forward 14=EP Monitoring 15=Yield 16=EP Fixed 17=EP Control 18=EP Angle shutoff 19=Yield / torque control OR 20=Snug gradient 21=Residual torque / Time 22=Residual torque / Angle 23=Breakaway peak 24=Loose and tightening 25=Home position reverse 26=PVT comp with Snug
02060	Rotation direction	1 = CW, 2 = CCW
01003	Time of last change in tightening program settings	Date and time of last change in tightening program settings. OBS. Only to be sent at upload with MID 02501.
01005	Tightening strategy	One stage = 0, Two stage = 1, Quick step = 2, Ergo ramp = 3
	ETC	

5.3.19.5 PF Accessibility Configuration

Below is shown where in TTPF the configuration of accessibility to PF program creation shall be set for those controllers that use password accessibility function.

If a password is NOT set the program download and creation should be possible to do. If a password IS SET the creation should not be able to do without prompting for a password in the implementation on the integrator side.

For password handling, the MID 2502 for PF to Integrator password request shall be used, which shall respond with MID 2503 containing the password text.

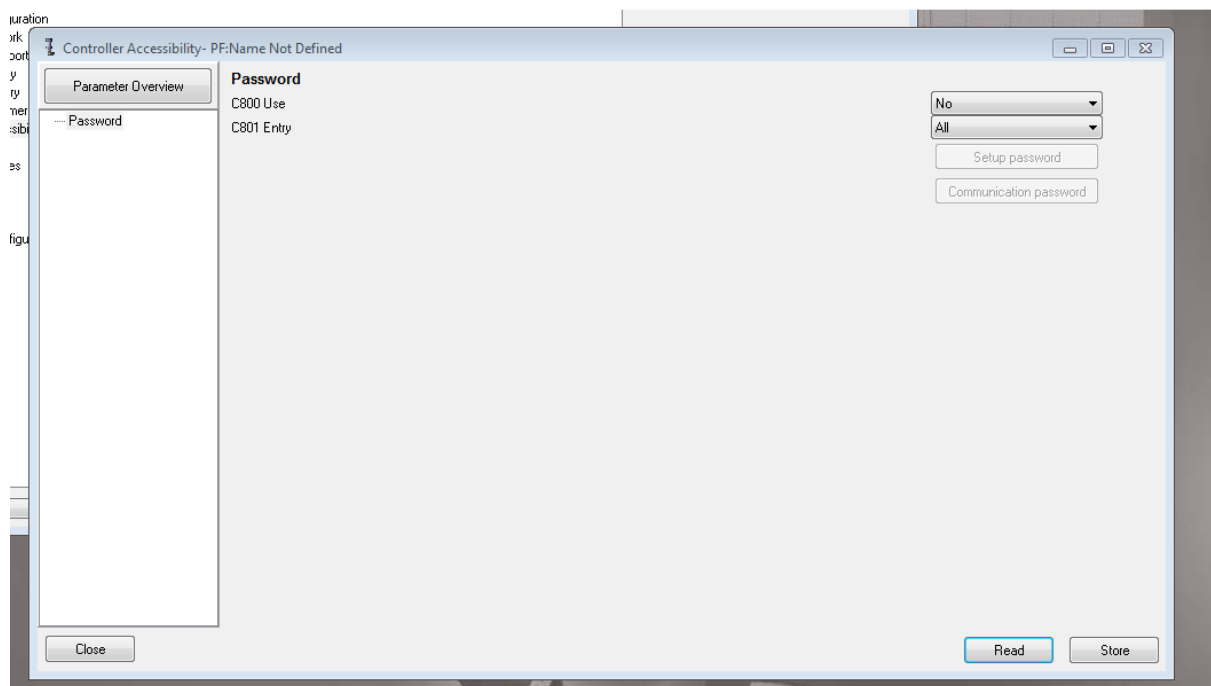

5.3.19.6 MID 2502 Password Request

This MID shall be used by the Controller if a password is defined for program download and creation. It consists only of the header structure.

5.3.19.7 MID 2503 Password Response

This MID shall contain the password text beginning at byte 21 after the header.

5.3.19.8 Example parameters for PM4000

Table 51 Example parameters for PM4000

Parameter id (PID)	Name	Description
Xxxxx	Step type	
Xxxxx	Speed	
Xxxxx	Direction	
02000	Toque final target	
Xxxxx	Restriction type	
Xxxxx	Restriction torque	
Etc		

5.3.19.9 Example for a simple Pset

A Parameter Set message will be sent like this (only an example, the actual data types and values will vary).

The example program is a single stage tightening that run to 10 Nm in clock wise direction and is only showing an extracted part of a longer message where it could be a mandatory to have , for instance, the tool type included..

```

Node Type = "001" - Parameter Set
Number of parameters = "002" (for example)
Parameter Id = "02100" - Rotation direction
Length = "001"
Data type = "01" - UI
Unit = "000" - No unit
Step no = "0000"
Data value = "1" - CW
Parameter Id = "02000" - Target torque
Length = "004"
Data type = "03" - Float
Unit = "001" - Nm
Step no = "0000"
Data value = "10.0"
Number of children = "00"

```

The example message will then have a data field like this:

```
0010020210000101000000010200000403001000010.000
```

5.3.19.10 Example for a tree structure message

A tightening program telegram for a tree structure message will be sent like this (only an example, the actual data types and values will vary).

The example program is a two-step tightening that run to 10 Nm in the first step and 15 Nm in step 2 and is only showing an extracted part of a longer message where it could be a mandatory to have , for instance, the tool type included.

```
Node Type = "100" - Tightening program
Number of parameters = "000"
Number of children = "02"
Node Type = "101" - Tightening Step
Number of parameters = "001"
Parameter Id = "02000" - Target torque
Length = "004"
Data type = "03" - Float
Unit = "001" - Nm
Step no = "0000"
Data value = "10.0"
Number of children = "00"
Node Type = "101" - Tightening Step
Number of parameters = "001"
Parameter Id = "02000" - Target torque
Length = "004"
Data type = "03" - Float
Unit = "001" - Nm
Step no = "0000"
Data value = "15.0"
Number of children = "00"
```

The example message will then have a data field like this:

```
100000021010010200000403001000010.0001010010200000403001000015.000
```

5.3.20 MID 2501 Tightening Program Message Upload

This MID contains the program parameter data and is used for upload of an existing program in the PF controller. The Generic data request MID 0006 shall be used for fetching this MID.

For continuous uploading of programs at changing/versioning the MID 0008 is used.

Typically this MID can be used for getting an already existing configured tightening program, for the purpose of to have it as a base and doing only the necessary changes for adoption to another tool than it was used for.

The variable data field parameters gotten should be dependent on the set Strategy and the Set valid and used parameters.

Message sent by: Controller

Answer version 1: Acknowledge by Integrator with **Link Level** MID 9997 if OK, MID 9998 if error and the **Application Level** MID 0005, MID 0004 Acknowledge, if sequence number in header <> 0.

Answer version 2: If sequence number isn't used the **Application Level** MID 0005, MID 0004 Acknowledge shall be used only.

5.3.20.1 Request for MID 2501 Extra data

Use MID 0006 to request for MID 2501 uploads. Table 52 shows the content in the "Extra data" field for this MID.

Table 52 MID 2501 Request extra data

Parameter	Size [byte]	Data type	Description
Program ID	4	UI	The program identification number. If equal to zero, fetch all node type programs.
Node Type	3	UI	The type of the node, see Table 49.

5.3.20.2 Subscription for MID 2501 Extra data

Use MID 0008 for subscription of MID 2501 uploads at versioning. Table 53 shows the content in the "Extra data" field for this MID.

Table 53 MID 2501 Subscription extra data

Parameter	Size [byte]	Data type	Description
Program ID	4	UI	The program identification number for a certain Program versioning upload on given node type. If equal to zero, send any Program that has been versioned for given node type.
Node Type	3	UI	The type of the node, see Table 49.

5.3.20.3 Data field 2501

The layout of the telegram is exactly the same as the layout of [MID 2500](#) Tightening Program Message download. See that section for a description.

5.3.21 MID 2506 Tightening Program Delete

Message sent by: Integrator
Answer: **MID 0005 Command accepted** or
MID 0004 Command error.

This message deletes one or all programs in controller.

Note: If a running program is included in MID 2506 deletion the program shall finish before deletion.

Note: Deleting programs included in other nodes may give unwanted behaviour. It will behave identical to a manual delete of the program.

For header description see section 2.2.2!

Table 54 Definition of required parameters for MID 2506

Parameter	Size [byte]	Data type	Description
Program ID	4	UI	The program identification number. A zero value is illegal and will give an error reply
Node Type	3	UI	The type of the node, see Table 49. Only 201 is allowed.

5.4 Application Mode MIDs

The MID's in this chapter are related to the Mode selection and follows the pattern for Parameter Sets (MID 0010-0018).

5.4.1 Functionality

Retrieve all Mode id's from the controller

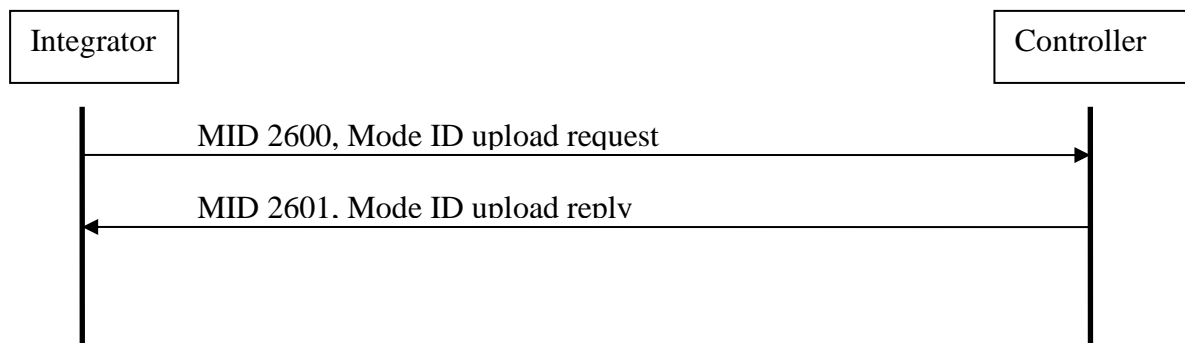

Retrieve data for a specific mode

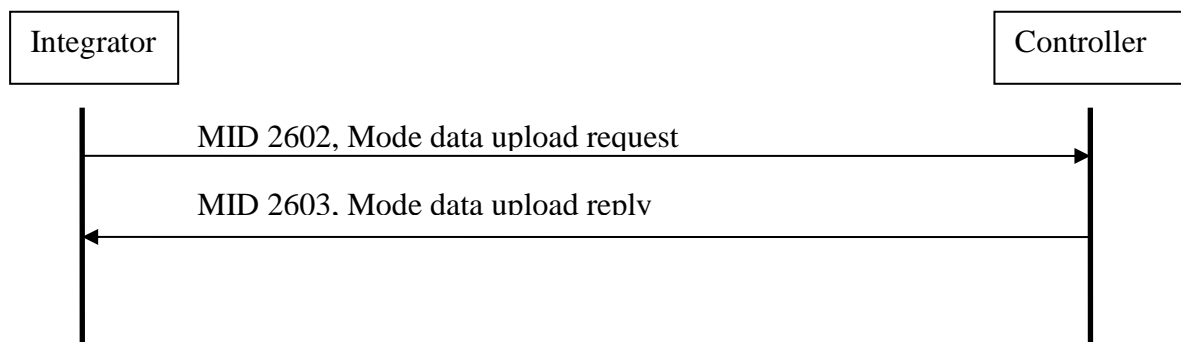

Get informed when a new mode is selected in the controller

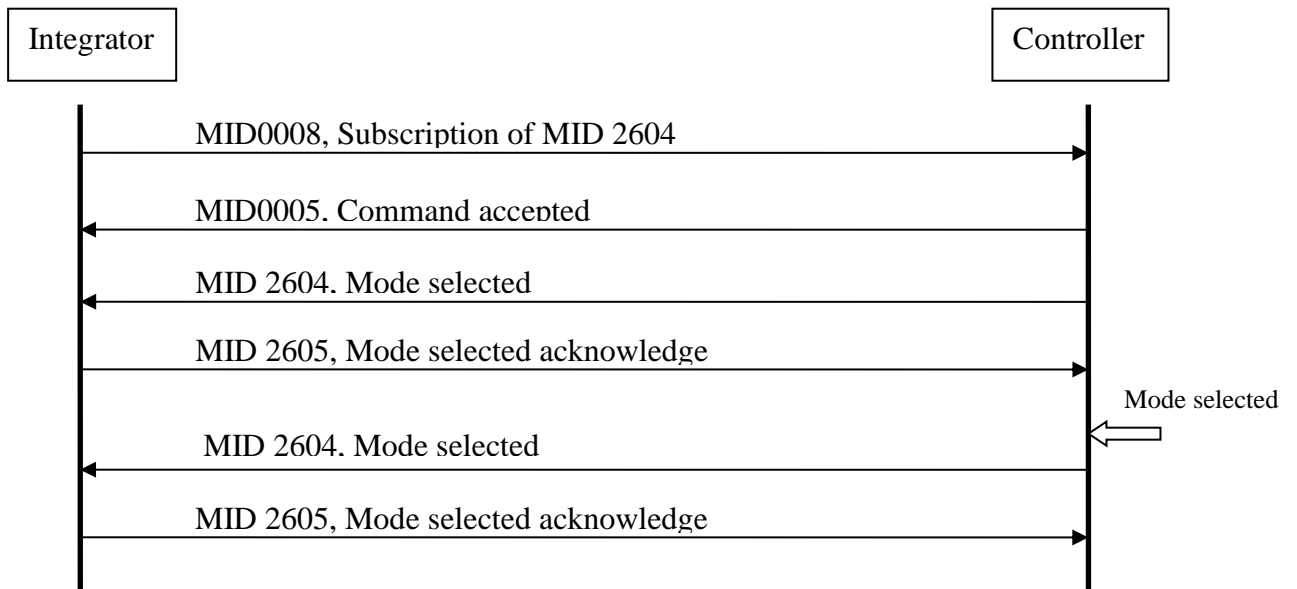

Select a mode in the controller

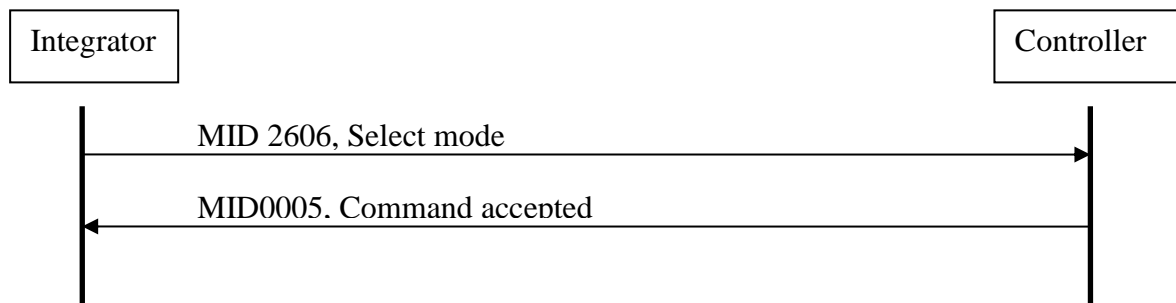

5.4.2 MID 2600 Mode ID upload request

A request to get the valid mode IDs from the controller.

Message sent by: Integrator

Answer: MID 2601 Mode ID upload reply

Data field, MID 2600

No data can be sent in the data field for this MID.

5.4.3 MID 2601 Mode ID upload reply

The transmission of all the valid mode IDs of the controller.

Message sent by: Controller

Answer: None

5.4.3.1 Data field, MID 2601

Table 55 MID 2601 Mode ID upload reply, revision 1

Parameter		Size [byte]	Data type	Description
The number of modes (N mode)		3	UI	Number of modes in the controller
Mode data, will repeat N mode times	Mode ID	4	UI	Mode id
	Mode Name Size	2	UI	Length of the mode name
	Mode Name	Mode Name Size	S	The name of the mode

5.4.4 MID 2602 Mode data upload request

Request to upload mode data from the controller.

Message sent by: Integrator

Answer:

MID 2603 Mode data upload reply, or

MID 0004 Command error, Parameter set not present

5.4.4.1 Data field, MID 2602

Table 56 MID 2602 Mode data upload request, revision 1

Parameter	Size [byte]	Data type	Description
Mode ID	4	UI	Mode id

5.4.5 MID 2603 Mode data upload reply

Upload of mode data reply.

Message sent by: Controller

Answer: None

5.4.5.1 Data field, MID 2603

Table 57 MID 2603 Mode data upload reply, revision 1

Parameter		Size [byte]	Data type	Description
Mode ID		4	UI	Mode id
Mode Name Size		2	UI	Length of the mode name
Mode Name		Mode Name Size	S	The mode name
No. bolts		3	UI	Number of bolts in the mode
Bolt data, will repeat No. bolts times	Pset id	3	UI	Parameter set id
	Tool number	3	UI	Tool number
	Bolt number	4	UI	Bolt number
	Bolt Name Size	2	UI	Length of the bolt name field
	Bolt name	Bolt Name Size	S	Bolt name

5.4.6 MID 2604 Mode selected

A new mode is selected in the controller. The message includes the ID of the mode selected as well as the date and time of the last change in the parameter set settings.

Message sent by: Controller

Answer: **MID 2605 Mode selected acknowledge**

5.4.6.1 Subscription, MID 2604

Use MID 0008 to start subscription. Note that the immediate response is **MID 0005 Command accepted** and **MID 2604 Mode selected**.

Data field, MID

Table 58 MID 2604, revision 1

Parameter	Size [byte]	Data type	Description
Mode ID	4	UI	Mode id
Date of last change in mode setting.	19	T	Date of last change in current mode.
No. bolts	3	UI	Number of bolts in the mode

5.4.7 MID 2605 Mode selected acknowledge

Acknowledgement for a new mode selected.

Message sent by: Integrator

Answer: None

5.4.7.1 Data field, MID

No data can be sent in the data field for this MID.

5.4.8 MID 2606 Select Mode

Select a parameter set.

Message sent by: Integrator

Answer: **MID 0005 Command accepted** or
MID 0004 Command error, Parameter set cannot be set

5.4.8.1 Data field, MID 2606

Table 59 MID 2606 data, revision 1

Parameter	Size [byte]	Data type	Description
Mode ID	4	UI	Mode to be selected.

5.5 Application Job messages

5.5.1 MID 0030 Job ID upload request

This is a request for a transmission of all the valid Job IDs of the controller. The result of this command is a transmission of all the valid Job IDs.

Message sent by: Integrator.
Answer: **MID 0031 Job ID upload reply**

For header description see section 2.2.2!

5.5.2 MID 0031 Job ID upload reply

The transmission of all the valid Job IDs of the controller. The data field contains the number of valid Jobs currently present in the controller, and the ID of each Job.

Message sent by: Controller
Answer: None

Example revision 1: Job 1 and 2 are present in the controller.

00260031001	020102NUL
-------------	-----------

Example revision 2: Job 1 and 2 are present in the controller.

00290031002	00200010002NUL
-------------	----------------

For header description see section 2.2.2!

Table 60 MID 0031 Revision 1

Parameter	Byte	Value
Number of Jobs	21-22	Two ASCII digits, range 00-99.
Job ID of each Job present in the controller	23-(22 + nof Jobs x 2)	Two ASCII digits for each Job. Range: 00-99.

Table 61 MID 0031 Revision 2

Parameter	Byte	Value
Number of Jobs	21-24	Four ASCII digits, range 0000-9999.
Job ID of each Job present in the controller	25-(24 + nof Jobs x 4)	Four ASCII digits for each Job. Range: 0000-9999.

5.5.3 MID 0032 Job data upload request

Request to upload the data for a specific Job from the controller.

Message sent by: Integrator
 Answer: **MID 0033 Job data upload** or
MID 0004 Command error, Job ID not present

Example: Upload Job data for Job 1

00220032	01NUL
----------	-------

For header description see section 2.2.2!

Table 62 MID 0032 Revision 1

Parameter	Byte	Value
Job ID	21-22	Two ASCII digits for the Job Id. Range: 00-99.

Table 63 MID 0032 Revision 2, 3 and 4

Parameter	Byte	Value
Job ID	21-24	Four ASCII digits for the Job ID. Range: 0000-9999. Job ID = 0000, current job executed on the fly

5.5.4 MID 0033 Job data upload reply

This message is sent as a reply to the **MID 0032 Job data request**.

Message sent by: Controller

Answer: None

For header description see section 2.2.2!

Table 64 MID 0033 Job data Revision 1

Parameter	Byte	Value
Job ID	21-22	01
	23-24	The Job ID is specified by two ASCII characters. Range: 00-99
Job name	25-26	02
	27-51	25 ASCII characters.
Forced order	52-53	03
	54	One ASCII character: 0=free order, 1=forced order, 2=free and forced
Max time for first tightening	55-56	04
	57-60	Four ASCII digits, range 0000-9999, 0000=not used
Max time to complete Job	61-62	05
	63-67	Five ASCII digits, range 00000-99999, 00000=not used
Job batch mode/ batch count type	68-69	06
	70	The Job batch mode is the way to count the tightening in a Job; only the OK or both OK and NOK. One ASCII character. 0=only the OK tightenings are counted 1=both the OK and NOK tightenings are counted
Lock at Job done	71-72	07
	73	One ASCII character: 0=No, 1=Yes
Use line control	74-75	08
	76	One ASCII character: 0=No, 1=Yes
Repeat Job	77-78	09
	79	One ASCII character: 0=No, 1=Yes
Tool loosening	80-81	10
	82	Tool loosening. One ASCII character. 0=Enable, 1=Disable, 2=Enable only on NOK tightening
Reserved	83-84	11
	85	Reserved for Job repair. One ASCII character. 0=E, 1=G
Number of parameter sets	86-87	12
	88-89	The number of parameter sets in the Job list, defined by two ASCII characters, range 00-99.

Parameter	Byte	Value
Job list	90-91	13
	92-(91+N x 12)	A list of parameter sets (N=value from parameter "Number of parameter sets", max 50). Each parameter set is defined by a number of parameters separated by ":" and terminated by ";" (12 bytes) according to: [Channel-ID]:[Type-ID]:[AutoValue]:[BatchSize]; Channel-ID = two ASCII characters, range 00-99 Type ID = parameter set ID or Multistage ID, three ASCII characters, range 000-999 Auto Value = One ASCII character, 1 or 0, 1=for Auto Next Change, BatchSize = Two ASCII characters, range 00-99 Example: 15:011:0:22;

Table 65 MID 0033 Job data Revision 2

Parameter	Byte	Value
Job ID	21-22	01
	23-26	The Job ID is specified by four ASCII characters. Range: 0000-9999
Job name	27-28	02
	29-53	25 ASCII characters.
Forced order	54-55	03
	56	One ASCII character: 0=free order, 1=forced order, 2=free and forced
Max time for first tightening	57-58	04
	59-62	Four ASCII digits, range 0000-9999, 0000=not used
Max time to complete Job	63-64	05
	65-69	Five ASCII digits, range 00000-99999, 00000=not used
Job batch mode/ batch count type	70-71	06
	72	The Job batch mode is the way to count the tightening in a Job; only the OK or both OK and NOK. One ASCII character. 0=only the OK tightenings are counted 1=both the OK and NOK tightenings are counted
Lock at Job done	73-74	07
	75	One ASCII character: 0=No, 1=Yes
Use line control	76-77	08
	78	One ASCII character: 0=No, 1=Yes
Repeat Job	79-80	09
	81	One ASCII character: 0=No, 1=Yes

All messages

Parameter	Byte	Value
Tool loosening	82-83	10
	84	Tool loosening. One ASCII character. 0=Enable, 1=Disable, 2=Enable only on NOK tightening
Reserved	85-86	11
	87	Reserved for Job repair. One ASCII character. 0=E, 1=G
Number of parameter sets	88-89	12
	90-91	The number of parameter sets in the Job list, defined by two ASCII characters, range 00-99.
Job list	92-93	13
	94-(93+N x 12)	A list of parameter sets (N=value from parameter "Number of parameter sets", max 50). Each parameter set is defined by a number of parameters separated by ":" and terminated by ";" (12 bytes) according to: [Channel-ID]:[Type-ID]:[AutoValue]:[BatchSize]; Channel-ID = two ASCII characters, range 00-99 Type ID = parameter set ID or Multistage ID, three ASCII characters, range 000-999 Auto Value = One ASCII character, 1 or 0, 1=for Auto Next Change, BatchSize = Two ASCII characters, range 00-99 Example: 15:011:0:22;

Table 66 MID 0033 Job data Revision 3

Parameter	Byte	Value
Job list	92-93	13
	94-(93+N x 44)	<p>A list of parameter sets (N=value from parameter "Number of parameter sets", max 50). Each parameter set is defined by a number of parameters separated by ":" and terminated by ";" (44 bytes) according to:</p> <p>[Channel-ID]:[Type-ID]:[AutoValue]:[BatchSize]:[Socket]:[Job step name]:[Job step type];</p> <p>Channel-ID = two ASCII characters, range 00-99 Type ID = parameter set ID or Multistage ID, three ASCII characters, range 000-999 Auto Value = One ASCII character, 1 or 0, 1=for Auto Next Change, BatchSize = Two ASCII characters, range 00-99 Socket = Two ASCII characters, range 00-99 (socket used) Job step name = 25 ASCII characters Job step type = Two ASCII characters, range 00-99 Batch step = 1 Reserved = 2-6</p> <p>Example: 15:011:0:22:02:Front axle :01;</p> <p>Observe that "Socket", "Job step name" and "Job step type" are NOT supported from PF4000, hence set to zeroes only.</p>

Table 67 MID 0033 Job data Revision 4

Parameter	Byte	Value
Job list	92 – 93	13
	94 – (93 + N x 49)	<p>A list of parameter sets (N=value from parameter "Number of parameter sets", max 50). Each parameter set is defined by a number of parameters separated by ":" and terminated by ";" (49 bytes) according to:</p> <p>[Channel-ID]:[Type-ID]:[AutoValue]:[BatchSize]:[IdentifierNumber]:[Job step name]:[Job step type]:[Max Coherent NOK];</p> <p>Channel-ID = two ASCII characters, range 00-99 Type ID = parameter set ID or Multistage ID, three ASCII characters, range 000-999 Auto Value = One ASCII character, 0, 1=for Auto Next Change, 2=I/O, 6=Fieldbus, 8=Socket tray BatchSize = Two ASCII characters, range 00-99 IdentifierNumber = Four ASCII characters, range 0000-9999(socket(s), EndFitting(s)...)) Job step name = 25 ASCII characters Job step type = Two ASCII characters, range 00-99 Batch step = 1 Reserved = 2-6 Max Coherent NOK = Two ASCII characters, range 00-99</p> <p>Example: 15:011:0:22:0002:Front axle :01:03;</p>

Table 68 MID 0033 Job data Revision 5

Parameter	Byte	Value
Job list	92 – 93	13
	94 – (93 + N x 51)	<p>A list of parameter sets (N=value from parameter “Number of parameter sets”, max 50). Each parameter set is defined by a number of parameters separated by “:” and terminated by “;” (51 bytes) according to: [Channel-ID]:[Type-ID]:[AutoValue]:[BatchSize]:[IdentifierNumber]:[Job step name]:[Job step type]:[Max Coherent NOK]; Channel-ID = two ASCII characters, range 00-99 Type ID = parameter set ID or Multistage ID, three ASCII characters, range 000-999 Auto Value = One ASCII character, 0, 1=for Auto Next Change, 2=I/O, 6=Fieldbus, 8=Socket tray BatchSize = Four ASCII characters, range 0000-9999 IdentifierNumber = Four ASCII characters, range 0000-9999(socket(s), EndFitting(s)...)) Job step name = 25 ASCII characters Job step type = Two ASCII characters, range 00-99 Batch step = 1 Reserved = 2-6 Max Coherent NOK = Two ASCII characters, range 00-99 Example: 15:011:0:0022:0002:Front axle :01:03;</p>

5.5.5 MID 0034 Job info subscribe

A subscription for the Job info. **MID 0035 Job info** is sent to the integrator when a new Job is selected and after each tightening performed during the Job.

Message sent by: Integrator
 Answer: **MID 0005 Command accepted** or
MID 0004 Command error, Job info subscription already exists

For header description see section 2.2.2!

5.5.6 MID 0035 Job info

The Job info subscriber will receive a Job info message after a Job has been selected and after each tightening performed in the Job. The Job info consists of the ID of the currently running Job, the Job status, the Job batch mode, the Job batch size and the Job batch counter.

Message sent by: Controller
 Answer: **MID 0036 Job info Acknowledge**

Example: Job info for Job 1

00630035	0101020030040008050003062001-12-01:20:12:45NUL
----------	--

For header description see section 2.2.2!

Table 69 MID 0035 Job info Revision 1

Parameter	Byte	Value
Job ID	21-22	01
	23-24	The Job ID is specified by two ASCII characters, range 00-99
Job status	25-26	02
	27	The Job batch status is specified by one ASCII character. 0=Job not completed, 1=Job OK, 2=Job NOK.
Job batch mode	28-29	03
	30	The Job batch mode is the way to count the tightening in a Job only the OK or both OK and NOK. One ASCII character 0= only the OK tightenings are counted 1= both the OK and NOK tightenings are counted
Job batch size	31-32	04
	33-36	This parameter gives the total number of tightening in the Job. The Job batch size is four bytes long. Four ASCII characters, range 0000-9999.

Parameter	Byte	Value
Job batch counter	37-38	05
	39-42	This parameter gives the current value of the Job batch counter. The Job is completed when the Job batch counter is equal to the Job batch size. The Job batch counter is four bytes long. Four ASCII characters, range 0000-9999.
Time stamp	43-44	06
	45-63	Time stamp for the Job info. The time stamp is 19 bytes long and is specified by 19 ASCII characters YYYY-MM-DD:HH:MM:SS.

Table 70 MID 0035 Job info Revision 2

Parameter	Byte	Value
Job ID	21-22	01
	23-26	The Job ID is specified by four ASCII characters, range 0000-9999
Job status	27-28	02
	29	The Job batch status is specified by one ASCII character. 0=Job not completed, 1=Job OK, 2=Job NOK.
Job batch mode	30-31	03
	32	The Job batch mode is the way to count the tightening in a Job only the OK or both OK and NOK. One ASCII character 0= only the OK tightenings are counted 1= both the OK and NOK tightenings are counted
Job batch size	33-34	04
	35-38	This parameter gives the total number of tightening in the Job. The Job batch size is four bytes long. Four ASCII characters, range 0000-9999.
Job batch counter	39-40	05
	41-44	This parameter gives the current value of the Job batch counter. The Job is completed when the Job batch counter is equal to the Job batch size. The Job batch counter is four bytes long. Four ASCII characters, range 0000-9999.
Time stamp	45-46	06
	47-65	Time stamp for the Job info. The time stamp is 19 bytes long and is specified by 19 ASCII characters YYYY-MM-DD:HH:MM:SS.

Table 71 MID 0035 Job info Revision 3

Parameter	Byte	Value
Job current step	66-67	07
	68-70	The number of the step currently executed in the job. 3 bytes long, 3 ASCII characters range 000-999. For PF4000, PF3000 is zero reported.
Job total number of steps	71-72	08
	73-75	The total number of steps in the job. 3 bytes long, 3 ASCII characters range 000-999. For PF4000, PF3000 is zero reported.
Job step type	76-77	09
	78-79	Job step type = Two ASCII characters, range 00-99 Batch step = 1 Reserved = 2-6 For PF4000, PF3000 is zero reported.

Table 72 MID 0035 Job info Revision 4

Parameter	Byte	Value
Job ID	21-22	01
	23-26	The Job ID is specified by four ASCII characters, range 0000-9999
Job status	27-28	02
	29	The Job batch status is specified by one ASCII character. 0=Job not completed, 1=Job OK, 2=Job NOK, 3=Job ABORTED, 4=Job restart
Job batch mode	30-31	03
	32	The Job batch mode is the way to count the tightening in a Job only the OK or both OK and NOK. One ASCII character 0= only the OK tightenings are counted 1= both the OK and NOK tightenings are counted
Job batch size	33-34	04
	35-38	This parameter gives the total number of tightening in the Job. The Job batch size is four bytes long. Four ASCII characters, range 0000-9999.
Job batch counter	39-40	05
	41-44	This parameter gives the current value of the Job batch counter. The Job is completed when the Job batch counter is equal to the Job batch size. The Job batch counter is four bytes long. Four ASCII characters, range 0000-9999.
Time stamp	45-46	06
	47-65	Time stamp for the Job info. The time stamp is 19 bytes long and is specified by 19 ASCII characters YYYY-MM-DD:HH:MM:SS.
Job current step	66-67	07

All messages

Parameter	Byte	Value
	68-70	The number of the step currently executed in the job. 3 bytes long, 3 ASCII characters range 000-999. For PF4000, PF3000 is zero reported.
Job total number of steps	71-72	08
	73-75	The total number of steps in the job. 3 bytes long, 3 ASCII characters range 000-999. For PF4000, PF3000 is zero reported.
Job step type	76-77	09
	78-79	Job step type = Two ASCII characters, range 00-99 Batch step = 1 Reserved = 2-6 For PF4000, PF3000 is zero reported.
Job tightening status	80-81	10
	82-83	The Job tightening status is specified by two ASCII character. 0=JobTight OFF, 1=JobTight OK, 2=JobTight NOK, 3=JobTight ABORTED, 4= JobTight INCREMENTED, 5=JobTight DECREMENTED, 6=JobTight BYPASSED, 7=JobTight RESET BATCH, 8=JobTight LOOSENING, 9=JobTight FREE BATCH, 10=JobTight JOB ABORTED, 11= JobTight JOB RESTART

Table 73 MID 0035 Job info Revision 5

Parameter	Byte	Value
Job sequence number	84-85	11
	86-90	The Job sequence number is unique for each Job. All tightenings performed in the same Job are stamped with the same Job sequence number. It is specified by five ASCII digits. Range: 00000-65535.
VIN number	91-92	12
	93-117	The VIN number is 25 bytes long and is specified by 25 ASCII characters.
Identifier result part 2	118-119	13
	120-144	The identifier result part 2 is 25 bytes long and is specified by 25 ASCII characters.
Identifier result part 3	145-146	14
	147-171	The identifier result part 3 is 25 bytes long and is specified by 25 ASCII characters.
Identifier result part 4	172-173	15
	174-198	The identifier result part 4 is 25 bytes long and is specified by 25 ASCII characters.

Table 74 MID 0035 Additions for Revision 6

Parameter		Byte	Value
Joint ID		199-200	16
		201-225	Exactly 25 left-aligned ASCII characters of the Joint ID assigned in source tightening. Right padded with spaces if Joint ID is under 25 characters. Cut off at 25 characters if it is longer.

5.5.7 MID 0036 Job info acknowledge

Acknowledgement of a Job info message.

Message sent by: Integrator
Answer: None

For header description see section 2.2.2!

5.5.8 MID 0037 Job info unsubscribe

Reset the subscription for a Job info message.

Message sent by: Integrator
Answer: **MID 0005 Command accepted** or
MID 0004 Command error, Job info subscription does not exist

For header description see section 2.2.2!

5.5.9 MID 0038 Select Job

Message to select Job. If the requested ID is not present in the controller, then the command will not be performed.

Message sent by: Integrator
Answer: **MID 0005 Command accepted** or
MID 0004 Command error, Job can not be set, or Invalid data

For header description see section 2.2.2!

Table 74 MID 0038 Job ID, revision 1

Parameter	Byte	Value
Job ID	21-22	The Job ID is specified by two ASCII characters. Range: 00-99

Table 75 MID 0038 Job ID, revision 2

Parameter	Byte	Value
Job ID	21-24	The Job ID is specified by four ASCII characters. Range: 0000-9999

5.5.10 MID 0039 Job restart

Job restart message.

Message sent by: Integrator

Answer: **MID 0005 Command accepted** or
MID 0004 Command error, Job not running, or Invalid data

Example: Restart Job 1

00220039	01NUL
----------	-------

For header description see section 2.2.2!

Table 76 MID 0039 Revision 1

Parameter	Byte	Value
Job ID	21-22	Two ASCII digits for the Job Id. Range: 00-99.

Table 77 MID 0039 Revision 2

Parameter	Byte	Value
Job ID	21-24	Four ASCII digits for the Job ID. Range: 0000-9999.

5.6 Application Tool messages

5.6.1 MID 0040 Tool data upload request

A request for some of the data stored in the tool. The result of this command is the transmission of the tool data.

Message sent by: Integrator

Answer: MID 0041 Tool data upload reply or
MID 0004 Command error, with code 29 – Tool does not exist

For header description see section 2.2.2!

Table 78 MID 0040 Tool data upload request revision 6 -7, no data for revision 0-5

Parameter	Byte	Value
Tool Number	21-22	01
	23-26	The number of the tool to send tool data for. It is the same number as the tool numbers sent in MID 0701 Tool List Upload 4 ASCII digits

5.6.2 MID 0041 Tool data upload reply

Upload of tool data from the controller.

Message sent by: Controller

Answer: None

Example: Tool data

00810041	01C341212	02548796
032001-05-07:13:24:5404670919	NUL	

For header description see section 2.2.2!

Table 79 MID 0041 Tool data, revision 1

Parameter	Byte	Value
Tool serial number	21-22	01
	23-36	14 ASCII characters
Tool number of tightening	37-38	02
	39-48	10 ASCII digits. Max 4294967295
Last calibration date	49-50	03
	51-69	19 ASCII characters. YYYY-MM-DD:HH:MM:SS
Controller serial number = Ford. RBU Serial = Normal	70-71	04
	72-81	10 ASCII characters

Table 80 MID 0041 Tool data, additions for revision 2

Parameter	Byte	Value
Calibration value	82-83	05
	84-89	The tool calibration value is multiplied by 100 and sent as an integer (2 decimals truncated). Six ASCII digits.
Last service date	90-91	06
	92-110	YYYY-MM-DD:HH:MM:SS
Tightenings since service	111-112	07
	113-122	The number of tightenings since last service is specified by 10 ASCII digits. Max 4294967295.
Tool type	123-124	08
	125-126	The tool type is specified by 2 ASCII digits: 00=No Tool, 01=S-tool, 02=DS-tool, 03=Ref. transducer, 04=ST-tool, 05=EP-tool, 06=ETX-tool, 07=SL-tool, 08=DL-tool, 09=IRC Offline, 10=STB-tool, 11=QST-tool, 12=STT-tool, 13=Stwrench, 14 = ES-tool, 15 = ESB, 16 = SB, 17 = SB+, 18 = PST-tool, 19 = STR-tool, 20 = ETD M, 21 = ETD MC, 22 = ETD MT, 23 = QMC, 24 = QMT, 25 = BCV-RE, 26 = BCP-RE, 27 = E-LIT, 28 = ISB, 29 = ITB, 30 = ITP, 31 = Qshield-C, 32 = DeltaWrench, 33 = STRWrench, 34 = XPBM, 35 = ExBC, 36 = ExD
Motor size	127-128	09
	129-130	The motor size is specified by 2 ASCII digits, range 00-99. 00 = no motor, 01-99 = motor size xx in Atlas Copco nomenclature, or motor size = 10xx in Atlas Copco nomenclature (certain numbers correspond to 2 different motor sizes, for example 62 for both motor size 62 and motor size 1062)
Open end data	131-132	10
	133-135	The open end data is specified by 3 ASCII digits. The first digit represents the "use open end": 1=true, 0=false. The second digit indicates the tightening direction: 0=CW, 1=CCW. The third digit indicates motor rotation: 0=normal, 1=inverted.
Controller software version	136-137	11
	138-156	The software version is specified by 19 ASCII characters.

Table 81 MID 0041 Tool data, additions for revision 3

Parameter	Byte	Value
Tool max torque	157-158	12

	159-164	The tool max toque value is multiplied by 100 and sent as an integer (2 decimals truncated). Six ASCII digits.
Gear ratio	165-166	13
	167-172	The gear ratio value is multiplied by 100 and sent as an integer (2 decimals truncated). Six ASCII digits.
Tool full speed	173-174	14
	175-180	The tool full speed value is multiplied by 100 and sent as an integer (2 decimals truncated). Six ASCII digits.

Table 82 MID 0041 Tool data, additions for revision 4

Parameter	Byte	Value
Primary tool	181-182	15
	183-184	Primary tool. The primary tool is two byte-long and specified by two ASCII digits. 01=Cable (invalid for IRC-controller), 02=IRC-B, 03=IRC-W

Table 83 MID 0041 Tool data, additions for revision 5

Parameter	Byte	Value
Tool model	185-186	16
	187-198	12 ASCII characters with padding at the end of the string if needed. The padding is done spaces.

Table 84 MID 0041 Tool data, additions for revision 6

Parameter	Byte	Value
Tool Number	199-200	17
	201-204	The number of the tool. It is the same number as the tool numbers sent in MID 0701 Tool List Upload In systems with only 1 tool the number sent will always be 0001 4 ASCII digits
Tool article number	205-206	18
	207-236	30 ASCII characters

Table 85 MID 0041 Tool data, additions for revision 7

Parameter	Byte	Value
Rundown min speed	237-238	19
	239-244	The rundown min speed value is multiplied by 100 and sent as an integer(2 decimals truncated).6 ASCII digits
Downshift max speed	245-246	20
	247-252	The downshift max speed value is multiplied by 100 and sent as an integer(2 decimals truncated).6 ASCII digits
Downshift min speed	253-254	21

	255-260	The downshift min speed value is multiplied by 100 and sent as an integer(2 decimals truncated).6 ASCII digits
--	---------	--

5.6.3 MID 0042 Disable tool

Disable tool.

Message sent by: Integrator
 Answer: **MID 0005 Command accepted** or
MID 0004 Command error, with codes
 29 – Tool does not exist
 36 – Lock type not supported

For header description see section 2.2.2!

In revision 0-1 no extra data shall be sent. From revision 2 it is possible to disable or inhibit one tool if multiple tools are connected to the station, for example in a fixture. The number of the tool to disable or inhibit is specified in the telegram. If the tool number is set to 9999 all tools connected to the controller or station is disabled or inhibited.

Table 86 MID 0042 Disable tool, additions for revision 2, no data in revision 0-1

Parameter	Byte	Value
Tool Number	21-22	01
	23-26	The number of the tool to disable. It is the same number as the tool numbers sent in MID 0701 Tool List Upload 4 ASCII digits
Disable type	27-28	02
	29-30	The type of disable: 00 = Disable (lock) 01 = Inhibit NOK 02 = Inhibit OK 03 = Inhibit No result 2 ASCII digits

Definition of each disable type:

- **Disable** – This is the same function as the revision 1 functionality. The tool is locked and cannot be started.
- **Inhibit NOK** – Will not run in the next tightening but will be included in the final result with status NOK
- **Inhibit OK** – Will not run in the next tightening but will be included in the final result with status OK
- **Inhibit No Result** – Will not run in the next tightening and will not be included in the final result

5.6.4 MID 0043 Enable tool

Enable the tool in revision 0-1. For revision 2, will release the inhibit / disable value set with MID 0042 Disable tool. The number of the tool to release is specified in the telegram. If the tool number is set to 9999 all tools connected to the controller or station will be released.

Message sent by: Integrator
 Answer: **MID 0005 Command accepted** or
MID 0004 Command error, with code 29 – Tool does not exist

For header description see section 2.2.2!

Table 87 MID 0043 Enable tool, additions for revision 2, no data in revision 0-1

Parameter	Byte	Value
Tool Number	21-22	01
	23-26	The number of the tool to enable. It is the same number as the tool numbers sent in MID 0701 Tool List Upload 4 ASCII digits

5.6.5 MID 0044 Disconnect tool request

This command is sent by the integrator in order to request the possibility to disconnect the tool from the controller. The command is rejected if the tool is currently used.

When the command is accepted the operator can disconnect the tool and replace it (hot swap).

Message sent by: Integrator
 Answer: **MID 0005 Command accepted** or
MID 0004 Command error, Tool currently in use

For header description see section 2.2.2!

5.6.6 MID 0045 Set calibration value request

This message is sent by the integrator in order to set the calibration value of the tool.

Message sent by: Integrator
 Answer: **MID 0005 Command accepted** or
MID 0004 Command error, with code Calibration failed

Example: Request for setting a calibration value of 35,5 Nm.

00310045	01102003550NUL
----------	----------------

For header description see section 2.2.2!

Table 88 MID 0045 Set calibration value request revision 1

Parameter	Byte	Value
Calibration value Unit	21-22	01
	23	The unit in which the calibration value is sent. The calibration value unit is one byte long and specified by one ASCII digit. 1=Nm, 2=Lbf.ft, 3=Lbf.ln, 4=Kpm, 5=Kgf.cm, 6=ozf.in, 7=% , 8=Ncm, 9=kNm
Calibration value	24-25	02
	26-31	The calibration value is multiplied by 100 and sent as an integer (2 decimals truncated). The calibration value is six bytes long and is specified by six ASCII digits.

Table 89 MID 0045 Set calibration value request, additions for revision 2

Parameter	Byte	Value
Channel Number	32-33	03
	34-35	The number of the channel to set the calibration value. 2 ASCII digits

Table 90 MID 0045 Set calibration value request, additions for revision 3

Parameter	Byte	Value
Extended calibration value	36-37	04
	38-47	The calibration value is multiplied by 10 000 and sent as an integer (4 decimals truncated). The calibration value is ten bytes long and is specified by ten ASCII digits.
Transducer number	48-49	05
	50-51	The transducer number if the tool has more than one transducer. Specified by one ASCII digit (1-9). For a tool with only one transducer 1 or space can be used.

5.6.7 MID 0046 Set primary tool request

This message is sent by the integrator in order to set tool data.

Warning 1: this MID requires **programming control** (see 4.4 Programming control).

Warning 2: the new configuration will not be active until the next controller reboot!

Message sent by: Integrator

Answer: **MID 0005 Command accepted** or
MID 0004 Command error, Programming control not granted
or **Invalid data** (value not supported by controller)

Example: Request for setting primary tool to Cable.

00240046	0101NUL
----------	---------

For header description see section 2.2.2!

Table 91 MID 0046 Primary tool, revision 000-001

Parameter	Byte	Value
Primary tool	21-22	01
	23-24	Primary tool. The primary tool is two byte-long and specified by two ASCII digits. 01=Cable (invalid for IRC-controller), 02=IRC-B, 03=IRC-W

5.6.8 MID 0047 Tool Pairing handling

This message is sent by the integrator in order to Pair tools, to abort ongoing pairing, to Abort/Disconnect established connection and request for pairing status of the IRC-B or IRC-W tool types. At pairing handling type, Start Pairing and Pairing Abort or Disconnect the controller must take program control and release when finished. MID 0048 will be uploaded during the pairing process at each change of the pairing stage.

Message sent by: Integrator
 Answer: **MID 0005 Command accepted at pairing status ACCEPTED**
MID 0004 Command error. See error codes.
MID 0048 Pairing status during the pairing process

For header description see section 2.2.2!

Table 92 MID 0047 Tool Pairing handling, revision 000-001

Parameter	Byte	Value
Pairing handling type	21-22	01
	23-24	Type of handling, a two byte-long and specified by two ASCII digits. 01 = Start Pairing 02 = Pairing Abort or Disconnect 03 = Fetch latest pairing status.

5.6.9 MID 0048 Tool Pairing status

This message is sent by the controller in order to report the current status of the tool pairing.

Message sent by: Controller

Answer: N/A

For header description see section 2.2.2!

Table 93 MID 0048 Tool Pairing status Revision 000-001

Parameter	Byte	Value
Pairing status	21-22	01
	23-24	Status of the tool pairing, a two byte-long and specified by two ASCII digits. 00 = UNDEFINED. Tool not mounted yet 01= ACCEPTED. Pairing allowed and started 02=INQUIRY. Normal pairing sequence as OK 03=SENDPIN. -- -- 04=PINOK -- -- 05=READY -- -- 06=ABORTED. Ongoing Pairing aborted. 07=DENIED. Pairing not allowed. Program control. 08=FAILED. Pairing attempt failed 09=UNREADY. Pairing never done before or disconnected
Time stamp	25-26	02
	27-45	Time stamp for each status change or time for fetch. It is 19 bytes long and is specified by 19 ASCII characters (YYYY-MM-DD:HH:MM:SS).

5.6.10 MID 0700 Tightening data download status

Used by controller to upload the status of tightening data download to a radio connected tool.

Must be subscribed for by generic MID 0008 and unsubscribed for with generic MID 0009.

No extra data is needed and no historical data is applicable.

Message sent by: Controller

Answer: MID 0005

For header description see section 2.2.2!

Table 94 MID 0700 Data

Message part	Parameter	Byte	Value
Data field	Tightening data download status in tool	21-23	Number of variable parameters.
Variable parameters	Tightening data download status in tool	23-x	Tightening data tool download status. See variable parameters.

5.6.11 MID 0701 Tool list upload reply

Upload a list of connected tools from controller.

Message sent by: Controller

Answer: None

The list will contain all tools that are connected to the controller or station.

To request the data **MID 0006 Application data message request** without any extra data is used.

Table 95 MID 0701 Tool list upload reply revision 1

Parameter	Size [byte]	Data type	Description	
The number of tools (N tool)	3	UI	The number of tools connected to the controller or station	
Tool data, will repeat N tool times	Tool Number	4	UI	The number of the tool
	Tool serial number	30	S	Serial number of the tool
	Tool Model Name	30	S	Model name of the Tool
	Tool Model Article Number	30	S	Article Number of the Tool

5.6.12 MID 0702 Tool Data upload reply with generic data

Upload a list of connected tools from controller.

Message sent by: Controller

Answer: None

The list will contain all tool parameters that are connected to the controller or station.

To request the data **MID 0006 Application data message request** with required extra data is used.

Table 96 MID 0702 Request extra data

Parameter	Byte	Value
Tool Number	21-22	01
	23-26	The number of the tool to send tool data for. It is the same number as the tool numbers sent in MID 0701 Tool List Upload 4 ASCII digits

For header description see section 2.2.2!

Table 97 MID 0702 Data

Message part	Parameter	Byte	Value
Data field	The number of tool parameters	21-23	Number of variable parameters.
Variable parameters	Tool data upload	23-x	Tool information

See [2.4 Variable data field use from OP spec 2.0](#)

Table 98 Examples of tool parameters PIDs that can be included as variable parameter:

Parameter id (PID)	Name	Description
01213	Tool Temperature	To read out the different tool temperatures

For PIDs that can be used with MID 0702: See Table 235 Tool Information PID list

A check for allowed PIDs to be included in this message should be done for each controller type.

5.6.13 MID 0703 Set calibration value request with generic data

This message is sent by the integrator in order to set the calibration value of the tool.

Message sent by: Integrator

Answer: **MID 0005 Command accepted** or
MID 0004 Command error, with code Calibration failed

For header description see section 2.2.2!

Table 99 MID 703 Data

Message part	Parameter	Byte	Value
	Tool Number	21-22	01
		23-26	The number of the tool to send tool data for. It is the same number as the tool numbers sent in MID 0701 Tool List Upload 4 ASCII digits
Data field	The number of calibration parameter	27-28	Number of variable parameters.
Variable parameters	Calibration parameters	28-x	Tool calibration information.

See [2.4 Variable data field use from OP spec 2.0](#)

Table 100 Examples of tool parameter PIDs that can be included as variable parameter:

Parameter id (PID)	Name	Description
01201	Tool article number	The article number of the tool that made the tightening. Will be sent as a string
01202	Tool serial number	The serial number of the tool that made the tightening. Will be sent as a string
01205	Tool number	The index or number of the tool

5.6.14 MID 0704 Tool Data status reply with generic data

Upload requested parameters from given tool.

Message sent by: Controller
Answer: None

The list will contain requested parameters from the tool.

Table 101 Examples of tool parameters PIDs that can be included as variable parameter:

Parameter id (PID)	Name	Description
01213	Tool Temperature	To read out the different tool temperatures
01215	Battery: State of charge	

For PIDs that can be used with MID 0704: See Table 235 Tool Information PID list

A check for allowed PIDs to be included in this message should be done for each controller type.

5.6.14.1 Request for MID 0704 Extra data

Use MID 0006 to request for MID 0704 uploads. Table 102 shows the content in the “Extra data” field for this MID.

Table 102 MID 0704 Request extra data

Parameter		Size [byte]	Data type	Description
Tool number		4	UI	Number as sent in MID 0701
The number of parameters		3	UI	The number of requested parameters (N).
Parameter IDs, will repeat N times	PID	6	UI	Requested parameter id

5.6.14.2 Subscription for MID 0704 Extra data

Use MID 0008 for subscription of MID 0704 uploads at versioning. Table 103 shows the content in the “Extra data” field for this MID. MID 0704 will be sent when any of the requested parameter is changed more than the given restriction.

Table 103 MID 0704 Subscription extra data

Parameter	Size [byte]	Data type	Description	
Tool number	4	UI	Number as sent in MID 0701	
The number of parameters	3	UI	The number of requested parameters (N).	
Parameter IDs and restrictions, will repeat N times	PID	6	UI	Requested parameter id
	Restriction	3	UI	Requested parameter must be changed more than restriction to trigger a transmission of MID 0704. Value 000 means no restriction.

As the restriction is given as an UI the value may be casted to the type for the requested parameter. For a string parameter only 000 is allowed. For time parameters the restriction is given in seconds.

Example: A request for temperature with a restriction of 5 will initiate a transmission of MID 0704 whenever the temperature has changed 5 degrees or more.

5.6.14.3 Unsubscription for MID 0704 Extra data

Use MID 0009 to unsubscribe a MID 0704. Table 104 shows the content in the “Extra data” field for this MID.

Table 104 MID 0704 Unsubscription extra data

Parameter	Size [byte]	Data type	Description
Tool number	4	UI	Number as sent in MID 0701

5.6.14.4 MID 0704 Data

As described in [2.4 Variable data field use from OP spec 2.0](#).

5.7 Application VIN Messages

5.7.1 MID 0050 Vehicle ID Number download request



This message is replaced by MID 0150. MID 0050 is still supported.

Used by the integrator to send a VIN number to the controller.

Message sent by: Integrator

Answer: **MID 0005 Command accepted** or
MID 0004 Command error, VIN input source not granted

For header description see section 2.2.2!

Table 105 MID 0050 Revision 1

Parameter	Byte	Value
VIN number	21-max 45	Dynamic with max 25 ASCII characters.

5.7.2 MID 0051 Vehicle ID Number subscribe

This message is used by the integrator to set a subscription for the current identifiers of the tightening result.

The tightening result can be stamped with up to four identifiers:

- VIN number
- Identifier result part 2
- Identifier result part 3
- Identifier result part 4

The identifiers are received by the controller from several input sources, for example serial, Ethernet, or field bus.

In revision 1 of the **MID 0052 Vehicle ID Number**, only the VIN number is transmitted. In revision 2, all four possible identifiers are transmitted.

Message sent by: Integrator

Answer: **MID 0005 Command accepted** or
MID 0004 Command error, VIN subscription already exists

For header description see section 2.2.2!

5.7.3 MID 0052 Vehicle ID Number

Transmission of the current identifiers of the tightening by the controller to the subscriber.

The tightening result can be stamped with up to four identifiers:

- VIN number (identifier result part 1)
- Identifier result part 2
- Identifier result part 3
- Identifier result part 4

The identifiers are received by the controller from several input sources, for example serial, Ethernet, or field bus.

Message sent by: Controller

Answer: **MID 0053 Vehicle ID Number acknowledge**

For header description see section 2.2.2!

Table 106 MID 0052 Identifier data, revision 1

Parameter	Byte	Value
VIN number	21-45	The VIN number is 25 bytes long and is specified by 25 ASCII characters. Note! Only for PowerMACS and rev 000-001, the VIN number can be up to <u>40</u> bytes long. Minimum number of bytes is always 25.

Table 107 MID 0052 Identifier data, additions for revision 2

Parameter	Byte	Value
VIN number	21-22	01
	23-47	The VIN number is 25 bytes long and is specified by 25 ASCII characters. Note! Only for PowerMACS and rev 000-001, the VIN number can be up to <u>40</u> bytes long. Minimum number of bytes is always 25.
Identifier result part 2	48-49	02
	50-74	The identifier result part 2 is 25 bytes long and is specified by 25 ASCII characters.
Identifier result part 3	75-76	03
	77-91	The identifier result part 3 is 25 bytes long and is specified by 25 ASCII characters.
Identifier result part 4	92-93	04
	94-128	The identifier result part 4 is 25 bytes long and is specified by 25 ASCII characters.

5.7.4 MID 0053 Vehicle ID Number acknowledge

Vehicle ID Number acknowledge.

Message sent by: Integrator

Answer: None

For header description see section 2.2.2!

5.7.5 MID 0054 Vehicle ID Number unsubscribe

Reset the subscription for the current tightening identifiers.

Message sent by: Integrator

Answer: **MID 0005 Command accepted** or
MID 0004 Command error, VIN subscription does not exist

For header description see section 2.2.2!

5.8 Application Tightening result messages

5.8.1 MID 0060 Last tightening result data subscribe

Set the subscription for the result tightenings. The result of this command will be the transmission of the tightening result after the tightening is performed (push function). The MID revision in the header is used to subscribe to different revisions of **MID 0061 Last tightening result data upload reply**.

Message sent by: Integrator
 Answer: **MID 0005 Command accepted** or
MID 0004 Command error, Last tightening subscription already exists or
MID revision not supported

For header description see section 2.2.2!

5.8.2 MID 0061 Last tightening result data

Upload the last tightening result. The following tables show the revisions available:

Message sent by: Controller
 Answer: **MID 0062 Last tightening result data acknowledge**

Example: **MID 0061 Last tightening result data upload reply**, revision 1

023100610010	010001020103airbag7
04KPOL3456JKL0897	05000600307000008000009010011112000840
130014001400120015000739160000017099991800000	
1900000202001-06-02:09:54:09212001-05-29:12:34:3322123345675	NUL

For header description see section 2.2.2!

Table 108 MID 0061 Revision 1

Parameter	Byte	Value
Cell ID	21-22	01
	23-26	The cell ID is four bytes long and specified by four ASCII digits. Range: 0000-9999.
Channel ID	27-28	02
	29-30	The channel ID is two bytes long and specified by two ASCII digits. Range: 00-99.
Torque controller Name	31-32	03
	33-57	The controller name is 25 bytes long and is specified by 25 ASCII characters.
VIN Number	58-59	04
	60-84	The VIN number is 25 bytes long and is specified by 25 ASCII characters.
Job ID	85-86	05
	87-88	The Job ID is two bytes long and specified by two ASCII digits. Range: 00-99
Parameter set ID	89-90	06
	91-93	The parameter set ID is three bytes long and specified by three ASCII digits. Range: 000-999.
Batch size	94-95	07
	96-99	This parameter gives the total number of tightening in the batch. The batch size is four bytes long and specified by four ASCII digits. Range: 0000-9999.
Batch counter	100-101	08
	102-105	The batch counter information is four bytes long specifying and specified by four ASCII digits. Range: 0000-9999.
Tightening Status	106-107	09
	108	The tightening status is one byte long and specified by one ASCII digit. 0=tightening NOK, 1=tightening OK.
Torque status	109-110	10
	111	0=Low, 1=OK, 2=High
Angle status	112-113	11
	114	0=Low, 1=OK, 2=High
Torque Min limit	115-116	12
	117-122	The torque min limit is multiplied by 100 and sent as an integer (2 decimals truncated). It is six bytes long and is specified by six ASCII digits.
Torque Max limit	123-124	13
	125-130	The torque max limit is multiplied by 100 and sent as an integer (2 decimals truncated). It is six bytes long and is specified by six ASCII digits.

Parameter	Byte	Value
Torque final target	131-132	14
	133-138	The torque final target is multiplied by 100 and sent as an integer (2 decimals truncated). It is six bytes long and is specified by six ASCII digits.
Torque	139-140	15
	141-146	The torque value is multiplied by 100 and sent as an integer (2 decimals truncated). It is six bytes long and is specified by six ASCII digits.
Angle Min	147-148	16
	149-153	The angle min value in degrees. Each turn represents 360 degrees. It is five bytes long and specified by five ASCII digits. Range: 00000-99999.
Angle Max	154-155	17
	156-160	The angle max value in degrees. Each turn represents 360 degrees. It is five bytes long and specified by five ASCII digits. Range: 00000-99999.
Final Angle Target	161-162	18
	163-167	The target angle value in degrees. Each turn represents 360 degrees. It is five bytes long and specified by five ASCII digits. Range: 00000-99999.
Angle	168-169	19
	170-174	The turning angle value in degrees. Each turn represents 360 degrees. It is five bytes long and specified by five ASCII digits. Range: 00000-99999.
Time stamp	175-176	20
	177-195	Time stamp for each tightening. It is 19 bytes long and is specified by 19 ASCII characters (YYYY-MM-DD:HH:MM:SS).
Date/time of last change in parameter set settings	196-197	21
	198-216	Time stamp for the last change in the current parameter set settings. It is 19 bytes long and is specified by 19 ASCII characters (YYYY-MM-DD:HH:MM:SS).
Batch status	217-218	22
	219	The batch status is specified by one ASCII character. 0=batch NOK, 1=batch OK, 2=batch not used, 3=batch running
Tightening ID	220-221	23
	222-231	The tightening ID is a unique ID for each tightening result. It is incremented after each tightening. 10 ASCII digits. Max 4294967295

Table 109 MID 0061 Revision 2

Parameter	Byte	Value
Cell ID	21-22	01
	23-26	The cell ID is four bytes long and specified by four ASCII digits. Range: 0000-9999.
Channel ID	27-28	02
	29-30	The channel ID is two bytes long and specified by two ASCII digits. Range: 00-99.
Torque controller Name	31-32	03
	33-57	The controller name is 25 bytes long and is specified by 25 ASCII characters.
VIN Number	58-59	04
	60-84	The VIN number is 25 bytes long and is specified by 25 ASCII characters.
Job ID	85-86	05
	87-90	The Job ID is four bytes long and specified by four ASCII digits. Range: 0000-9999
Parameter set number	91-92	06
	93-95	The parameter set ID is three bytes long and specified by three ASCII digits. Range: 000-999.
Strategy	96-97	07
	98-99	The strategies currently run by the controller. It is two bytes long and specified by two ASCII digits. Range: 00-99. The corresponding strategies are : 01=Torque control, 02=Torque control / angle monitoring, 03=Torque control / angle control AND, 04=Angle control / torque monitoring, 05=DS control, 06=DS control torque monitoring, 07=Reverse angle, 08=Reverse torque, 09=Click wrench, 10=Rotate spindle forward, 11=Torque control angle control OR, 12=Rotate spindle reverse, 13=Home position forward, 14=EP Monitoring, 15=Yield, 16=EP Fixed, 17=EP Control, 18=EP Angle shutoff, 19=Yield / torque control OR, 20=Snug gradient, 21=Residual torque / Time 22=Residual torque / Angle, 23=Breakaway peak 24=Loose and tightening, 25=Home position reverse, 26=PVT comp with Snug 99=No strategy
Strategy options	100-101	08

Parameter	Byte	Value
	102-106	Five bytes long bit field. Bit 0 Torque Bit 1 Angle Bit 2 Batch Bit 3 PVT Monitoring Bit 4 PVT Compensate Bit 5 Self-tap Bit 6 Rundown Bit 7 CM Bit 8 DS control Bit 9 Click Wrench Bit 10 RBW Monitoring
Batch size	107-108	09
	109-112	This parameter gives the total number of tightening in the batch. The batch size is four bytes long and specified by four ASCII digits. Range: 0000-9999.
Batch counter	113-114	10
	115-118	The batch counter information is four bytes long specifying and specified by four ASCII digits. Range: 0000-9999.
Tightening Status	119-120	11
	121	The tightening status is one byte long and is specified by one ASCII digit. 0=tightening NOK, 1=tightening OK. Note! For Ford the status is built on certain "Tightening error status" bits and "Result type", see fields below. See Ford appendix for detailed description.
Batch status	122-123	12
	124	The batch status is specified by one ASCII character. 0=batch NOK, 1=batch OK, 2=batch not used, 3=batch running
Torque status	125-126	13
	127	0=Low, 1=OK, 2=High
Angle status	128-129	14
	130	0=Low, 1=OK, 2=High
Rundown angle status	131-132	15
	133	0=Low, 1=OK, 2=High
Current Monitoring Status	134-135	16
	136	0=Low, 1=OK, 2=High
Self-tap status	137-138	17
	139	0=Low, 1=OK, 2=High
Prevail Torque monitoring status	140-141	18
	142	0=Low, 1=OK, 2=High
Prevail Torque compensate status	143-144	19
	145	0=Low, 1=OK, 2=High
Tightening error status	146-147	20

All messages

Parameter	Byte	Value
	148-157	Ten bytes long bit field. Tightening error bits show what went wrong with the tightening. Bit 1 Rundown angle max shut off Bit 2 Rundown angle min shut off Bit 3 Torque max shut off Bit 4 Angle max shut off Bit 5 Self-tap torque max shut off Bit 6 Self-tap torque min shut off Bit 7 Prevail torque max shut off Bit 8 Prevail torque min shut off Bit 9 Prevail torque compensate overflow Bit 10 Current monitoring max shut off Bit 11 Post view torque min torque shut off Bit 12 Post view torque max torque shut off Bit 13 Post view torque Angle too small Bit 14 Trigger lost Bit 15 Torque less than target Bit 16 Tool hot Bit 17 Multistage abort Bit 18 Rehit Bit 19 DS measure failed Bit 20 Current limit reached Bit 21 End Time out shutoff Bit 22 Remove fastener limit exceeded Bit 23 Disable drive Bit 24 Transducer lost Bit 25 Transducer shorted Bit 26 Transducer corrupt Bit 27 Sync timeout Bit 28 Dynamic current monitoring min Bit 29 Dynamic current monitoring max Bit 30 Angle max monitor Bit 31 Yield nut off Bit 32 Yield too few samples
Torque Min limit	158-159	21
	160-165	The torque min limit is multiplied by 100 and sent as an integer (2 decimals truncated). It is six bytes long and is specified by six ASCII digits.
Torque Max limit	166-167	22
	168-173	The torque max limit is multiplied by 100 and sent as an integer (2 decimals truncated). It is six bytes long and is specified by six ASCII digits.
Torque final target	174-175	23
	176-181	The torque final target is multiplied by 100 and sent as an integer (2 decimals truncated). It is six bytes long and is specified by six ASCII digits.
Torque	182-183	24
	184-189	The torque value is multiplied by 100 and sent as an integer (2 decimals truncated). It is six bytes long and is specified by six ASCII digits.
Angle Min	190-191	25
	192-196	The angle min value in degrees. Each turn represents 360 degrees. It is five bytes long and specified by five ASCII digits. Range: 00000-99999.

Parameter	Byte	Value
Angle Max	197-198	26
	199-203	The angle max value in degrees. Each turn represents 360 degrees. It is five bytes long and specified by five ASCII digits. Range: 00000-99999.
Final Angle Target	204-205	27
	206-210	The target angle value in degrees. Each turn represents 360 degrees. It is five bytes long and specified by five ASCII digits. Range: 00000-99999.
Angle	211-212	28
	213-217	The turning angle value in degrees. Each turn represents 360 degrees. It is five bytes long and specified by five ASCII digits. Range: 00000-99999.
Rundown angle Min	218-219	29
	220-224	The tightening angle min value in degrees. Each turn represents 360 degrees. It is five bytes long and specified by five ASCII digits. Range: 00000-99999.
Rundown angle Max	225-226	30
	227-231	The tightening angle max value in degrees. Each turn represents 360 degrees. It is five bytes long and specified by five ASCII digits. Range: 00000-99999.
Rundown angle	232-233	31
	234-238	The tightening angle value reached in degrees. Each turn represents 360 degrees. It is five bytes long and specified by five ASCII digits. Range: 00000-99999.
Current Monitoring Min	239-240	32
	241-243	The current monitoring min limit in percent is three bytes long and is specified by three ASCII digits. Range: 000-999.
Current Monitoring Max	244-245	33
	246-248	The current monitoring max limit in percent is three bytes long and is specified by three ASCII digits. Range: 000-999.
Current Monitoring Value	249-250	34
	251-253	The current monitoring value in percent is three bytes long and is specified by three ASCII digits. Range: 000-999.
Self-tap min	254-255	35
	256-261	The self-tap min limit is multiplied by 100 and sent as an integer (2 decimals truncated). It is six bytes long and specified by six ASCII digits.
Self-tap max	262-263	36
	264-269	The self-tap max limit is multiplied by 100 and sent as an integer (2 decimals truncated). It is six bytes long and specified by six ASCII digits.
Self-tap torque	270-271	37
	272-277	The self-tap torque is multiplied by 100 and sent as an integer (2 decimals truncated). It is six bytes long and specified by six ASCII digits.
	278-279	38

All messages

Parameter	Byte	Value
Prevail torque monitoring min	280-285	The PVTmin limit is multiplied by 100 and sent as an integer (2 decimals truncated). It is six bytes long and specified by six ASCII digits.
Prevail torque monitoring max	286-287	39
	288-293	The PVT max limit is multiplied by 100 and sent as an integer (2 decimals truncated). It is six bytes long and specified by six ASCII digits.
Prevail torque	294-295	40
	296-301	The prevail torque value is multiplied by 100 and sent as an integer (2 decimals truncated). The prevail torque is six bytes long and is specified by six ASCII digits.
Tightening ID	302-303	41
	304-313	The tightening ID is a unique ID. It is incremented after each tightening. It is ten bytes long and specified by ten ASCII digits. Max 4294967295.
Job sequence number	314-315	42
	316-320	The Job sequence number is unique for each Job. All tightenings performed in the same Job are stamped with the same Job sequence number. It is specified by five ASCII digits. Range: 00000-65535.
Sync tightening ID	321-322	43
	323-327	The sync tightening ID is a unique ID for each sync tightening result. Each individual result of each spindle is stamped with this ID. The tightening ID is incremented after each sync tightening. It is specified by five ASCII digits. Range: 00000-65535.
Tool serial number	328-329	44
	330-343	The Tool serial number is specified by 14 ASCII characters.
Time stamp	344-345	45
	346-364	Time stamp for the tightening. It is 19 bytes long and is specified by 19 ASCII characters (YYYY-MM-DD:HH:MM:SS).
Date/time of last change in parameter set settings	365-366	46
	367-385	Time stamp for the last change in the current parameter set settings. It is 19 bytes long and is specified by 19 ASCII characters (YYYY-MM-DD:HH:MM:SS).

Table 110 MID 0061 Revision 3

Parameter	Byte	Value
Parameter set Name	386-387	47
	388-412	The parameter set name is 25 bytes long and is specified by 25 ASCII characters.
Torque values Unit	413-414	48
	415	The unit in which the torque values are sent. The torque values unit is one byte long and is specified by one ASCII digit. 1=Nm, 2=Lbf.ft, 3=Lbf.ln, 4=Kpm 5=Kgf.cm, 6=ozf.in, 7=%, 8= Ncm
Result type	416-417	49
	418-419	The result type is two bytes long and specified by two ASCII digits. 1=Tightening, 2=Loosening, 3=Batch Increment 4=Batch decrement, 5=Bypass parameter set result 6=Abort Job result, 7=Sync tightening, 8=Reference setup, 9=Batch reset, 10=Job restart

Table 111 MID 0061 Revision 4

Parameter	Byte	Value
Identifier result part 2	420-421	50
	422-446	The identifier result part 2 is 25 bytes long and is specified by 25 ASCII characters.
Identifier result part 3	447-448	51
	449-473	The identifier result part 3 is 25 bytes long and is specified by 25 ASCII characters.
Identifier result part 4	474-475	52
	476-500	The identifier result part 4 is 25 bytes long and is specified by 25 ASCII characters.

Note: The identifier result parts will only be set if the multiple identifier option has been activated in the controller.

Table 112 MID 0061 Revision 5

Parameter	Byte	Value
Customer tightening error code	501-502	53
	503-506	The customer tightening error code is 4 byte long and is specified by 4 ASCII characters.

Table 113 MID 0061 Revision 6

Parameter	Byte	Value
Prevail Torque compensate value	507-508	54
	509-514	The PVT compensate torque value. It is multiplied by 100 and sent as an integer (2 decimals truncated). It is six bytes long and specified by six ASCII digits.
Tightening error status 2	515-516	55
	517-526	Bit field, Tightening error bits 2 shows what went wrong with the tightening. Bit 1 Drive deactivated Bit 2 Tool stall Bit 3 Drive hot Bit 4 Gradient monitoring high Bit 5 Gradient monitoring low Bit 6 Reaction bar failed Bit 7 Snug Max Bit 8 Cycle abort Bit 9 Necking failure Bit 10 Effective loosening Bit 11 Over speed Bit 12 No residual Torque Bit 13 Positioning fail Bit 14 Snug Mon. Low Bit 15 Snug Mon. High Bit 16 Dynamic Min. Current Bit 17 Dynamic Max. Current Bit 18 Latent result Bit 19-32 Reserved

Table 114 MID 0061 Revision 7

Parameter	Byte	Value
Compensated angle	527-528	56
	529-535	The compensated angle value is multiplied by 100 and sent as an integer. It is seven bytes long and specified by seven ASCII digits.
Final Angle Decimal	536-537	57
	538-544	The turning angle value is multiplied by 100 and sent as an integer (2 decimals truncated). It is seven bytes long and is specified by seven ASCII digits.

Table 115 MID 0061 Revision 8

Parameter	Byte	Value
Start final angle	545-546	58
	547-552	The start final angle is the torque to reach the snug level. The start final angle is multiplied by 100 and sent as an integer (2 decimals truncated). It is six bytes long and is specified by six ASCII digits.
Post view torque activated	553-554	59
	555	PostView Torque is On/Off 0=Off, 1=On, 2=Only PVTH on and 3=Only PVTL on

Parameter	Byte	Value
Post view torque high	556-557	60
	558-563	The post view torque high value. It is multiplied by 100 and sent as an integer (2 decimals truncated). It is six bytes long and specified by six ASCII digits.
Post view torque low	564-565	61
	566-571	The post view torque low value. It is multiplied by 100 and sent as an integer (2 decimals truncated). It is six bytes long and specified by six ASCII digits.

Table 116 MID 0061 Revision 9

Parameter	Byte	Value
Current Monitoring Amp	572-573	62
	574-578	The current monitoring value is multiplied by 100 and sent as an integer. It is five bytes long and specified by five ASCII digits. Range: 00000-99999. Value in Ampere Use blank space, when not used in implementation
Current Monitoring Amp Min	579-580	63
	581-585	The current monitoring min value is multiplied by 100 and sent as an integer. It is five bytes long and specified by five ASCII digits. Range: 00000-99999. Value in Ampere Use blank space, when not used in implementation
Current Monitoring Amp Max	586-587	64
	588-592	The current monitoring max value is multiplied by 100 and sent as an integer. It is five bytes long and specified by five ASCII digits. Range: 00000-99999. Value in Ampere Use blank space, when not used in implementation

Table 117 MID 0061 Revision 10

Parameter	Byte	Value
Angle numerator scale factor	593-594	65
	595-599	The scale factor defined by numerator / denominator applies on all angle values. Angle numerator scale factor is sent as an integer. It is five bytes long and specified by five ASCII digits. Range 00000-99999 Example: With 1/100 scale factor, angle value: 1.23° will be sent with value: 123
Angle denominator scale factor	600-601	66
	602-606	The scale factor defined by numerator / denominator applies on all angle values. Angle denominator scale factor is sent as an integer. It is five bytes long and specified by five ASCII digits. Range 00001-99999
Overall Angle Status	607-608	67

All messages

Parameter	Byte	Value
	609	Overall Angle is the total angle measured during the parameter set execution. OK when Overall Angle belongs to [Overall Angle Min ; Overall Angle Max] Low when Overall Angle < Overall Angle Min High when Overall Angle > Overall Angle Max 0=Low, 1=OK, 2=High
Overall Angle Min	610-611	68
	612-616	The overall angle min value in degrees. Each turn represents 360 degrees. It is five bytes long and specified by five ASCII digits. Range: -9999-99999. Note: Affected by angle scale factor.
Overall Angle Max	617-618	69
	619-623	The overall angle max value in degrees. Each turn represents 360 degrees. It is five bytes long and specified by five ASCII digits. Range: -9999-99999. Note: Affected by angle scale factor.
Overall Angle	624-625	70
	626-630	The overall angle value in degrees. Each turn represents 360 degrees. It is five bytes long and specified by five ASCII digits. Range: -9999-99999 Note: Affected by angle scale factor.
Peak Torque	631-632	71
	633-638	Peak Torque defines the highest torque value measured during the tightening. The peak torque value is multiplied by 100 and sent as an integer (2 decimals truncated). It is six bytes long and is specified by six ASCII digits.
Residual Breakaway Torque	639-640	72
	641-646	Residual Breakaway Torque defines the torque necessary to rotate the screw further. The breakaway torque value is multiplied by 100 and sent as an integer (2 decimals truncated). It is six bytes long and is specified by six ASCII digits.
Start Rundown angle	647-648	73
	649-654	The start rundown angle is the torque where the rundown angle monitoring starts. The start rundown angle is multiplied by 100 and sent as an integer (2 decimals truncated). It is six bytes long and is specified by six ASCII digits.
Rundown angle complete	655-656	74
	657-662	The rundown angle complete is the torque where the monitoring of rundown angle is stopped. The rundown angle complete is multiplied by 100 and sent as an integer (2 decimals truncated). It is six bytes long and is specified by six ASCII digits.

Table 118 MID 0061 Additions for Revision 11

Parameter	Byte	Value
Click torque	663-664	75
	665-670	The click torque value. It is multiplied by 100 and sent as an integer (2 decimals truncated). It is six bytes long and specified by six ASCII digits.
Click angle	671-672	76
	673-677	The click angle value. It is five bytes long and specified by five ASCII digits

Table 119 MID 0061 Additions for Revision 12

Parameter	Byte	Value
Selected Identifier Number	678-679	77
	680-683	The identifier number used to select the program is four bytes long and specified by four ASCII digits.
Joint ID	684-685	78
	673-677	Joint ID assigned in the source tightening. Only the first 25 characters of the Joint ID will be sent. Cut off at 25 characters if the Joint ID is longer.

Table 119 MID 0061 Revision 998

Note: Revision 998 is a continuation of Revision 6.

Parameter	Byte	Value
Number of stages in multistage	527-528	56
	529-530	The total number of stages to be run for this tightening. It is two bytes long and specified by two ASCII digits.
Number of stage results	531-532	57
	533-534	Number of run stages. It is two bytes long and specified by two ASCII digits. For each completed stage the final torque and the final angle are reported.
Stage result	535-536	58
	537-+11 x number of stage results	Byte 1-6: The stage torque value. The torque is multiplied by 100 and sent as an integer (2 decimals truncated). It is six bytes long and specified by six ASCII digits. Byte 7-11: The turning angle stage value in degrees. Each turn represents 360 degrees. It is five bytes long and specified by five ASCII digits. Range: 00000-99999.

Table 120 MID 0061 Light, revision 999

Parameter	Byte	Value
VIN Number	21-45	The VIN number is 25 bytes long and is specified by 25 ASCII characters taken.
Job ID	46-47	This is the Job ID. It is two bytes long and specified by two ASCII digits. Range: 00-99.
Parameter set ID	48-50	The parameter set ID is three bytes long and specified by three ASCII digits. Range: 000-999.
Batch size	51-54	This parameter gives the total number of tightening in the batch. It is four bytes long and specified by four ASCII digits. Range: 0000-9999.
Batch counter	55-58	The batch counter is four bytes long and specified by four ASCII digits. Range: 0000-9999.
Batch status	59	The batch status is specified by one ASCII character. 0=batch NOK (batch not completed), 1=batch OK, 2=batch not used.
Tightening status	60	The tightening status is one byte long and specified by one ASCII digit. 0=tightening NOK, 1=tightening OK.
Torque status	61	0=Low, 1=OK, 2=High
Angle status	62	0=Low, 1=OK, 2=High
Torque	63-68	The torque value is multiplied by 100 and sent as an integer (2 decimals truncated). It is six bytes long and is specified by six ASCII digits.
Angle	69-73	The turning angle value in degrees. Each turn represents 360 degrees. It is five bytes long and specified by five ASCII digits. Range: 00000-99999.

Parameter	Byte	Value
Time stamp	74-92	Time stamp for the tightening. It is 19 bytes long and is specified by 19 ASCII characters (YYYY-MM-DD:HH:MM:SS).
Date/time of last change in parameter set settings	93-111	Time stamp for the last change in the current parameter set settings. It is 19 bytes long and is specified by 19 ASCII characters (YYYY-MM-DD:HH:MM:SS).
Tightening ID	112-121	The tightening ID is a unique ID for each tightening result. It is incremented after each tightening. 10 ASCII digits. Max 4294967295

Note : The MID 0061 light revision 999 is intended to be used by integrators with limited receiving capability (small receive buffer). In order to limit the size of the MID 0061 as much as possible the parameter IDs usually sent in the message has been removed.

5.8.3 MID 0062 Last tightening result data acknowledge

Acknowledgement of last tightening result data.

Message sent by: Integrator
 Answer: None

For header description see section 2.2.2!

5.8.4 MID 0063 Last tightening result data unsubscribe

Reset the last tightening result subscription.

Message sent by: Integrator
 Answer: **MID 0005 Command accepted** or
MID 0004 Command error, Last tightening result subscription does not exist

For header description see section 2.2.2!

5.8.5 MID 0064 Old tightening result upload request

This message is a request to upload a particular tightening result from the controller. The requested result is specified by its unique ID (tightening ID). This message is useful after a failure of the network in order to retrieve the missing result during the communication interruption. The integrator can see the missing results by always comparing the last tightening IDs of the two last received tightening's packets (parameter 23 in the result message).

If both tightening ID and Offline result is zero, the request is for the latest tightening performed. If tightening ID is zero and Offline result is one, the request is for the latest tightening performed offline.

Otherwise the request is for the specified tightening ID independent of offline result flag.

Message sent by: Integrator
Answer: MID 0065 Old tightening result upload reply or
MID 0004 Command error, Tightening ID requested not found, or
MID revision not supported

For header description see section 2.2.2!

Table 121 MID 0064 Revision 1

Parameter	Byte	Value
Tightening ID	21-30	10 ASCII digits. Max 4294967295

Table 122 MID 0064 Revision 10

Parameter	Byte	Value
Tightening ID	21-30	10 ASCII digits. Max 4294967295
Offline result	31	0 or 1

MID 0064 Revision 999 – Reserved

5.8.6 MID 0065 Old tightening result upload reply

Old tightening upload. The following tables show the revisions available:

Table 123 MID 0065 Revision 1.

Table 124 MID 0065 Revision 2.

Table 125 MID 0065 Revision 3. Addition of parameters 29 and 30.

Table 126 MID 0065 Revision 4. Addition of parameters 31, 32 and 33.

Table 127 MID 0065 Revision 5. Addition of parameter 34.

Table 128 MID 0065 Revision 6. Addition of parameters 35 and 36.

Table 129 MID 0065 Revision 7. Addition of parameters 37 and 38.

Table 130 MID 0065 Revision 8. Addition of parameters 39, 40, 41 and 42.

Table 131 MID 0065 Revision 9. Addition of parameters 43, 44 and 45.

Table 132 MID 0065 Revision 10. Addition of parameters 46 to 55.

Table 133 MID 0065 Revision 11 Addition of parameters 56 and 57.

Table 6 MID 0065 Revision 12

Parameter	Byte	Value
Selected Identifier Number	513-514	58
	515-518	The identifier number used to select the program is four bytes long and specified by four ASCII digits.
Click angle	519-520	59
	521-545	Joint ID assigned in the source tightening. Only the first 25 characters of the Joint ID are sent. It is 25 characters long and is specified by 25 characters.

Table 134 MID 0065 Revision 998 Continuation of revision 6.

Table 135 MID 0065 Revision 12. Addition of parameters 58 and 59.

Message sent by: Controller

Answer: None

Example: MID 0065 Old tightening result upload reply, revision 1

```
01180065001      01456789  02AIRBAG
0300104002050060070080014670900046
102001-04-22:14:54:34142112
```

For header description see section 2.2.2!

Table 123 MID 0065 Revision 1

Parameter	Byte	Value
Tightening ID	21-22	01
	23-32	The tightening ID is a unique ID for each tightening result. It is incremented after each tightening. 10 ASCII digits. Max 4294967295
VIN Number	33-34	02
	35-59	The VIN number is 25 bytes long and is specified by 25 ASCII characters.
Parameter set ID	60-61	03
	62-64	The parameter set ID is three bytes long and specified by three ASCII digits. Range: 000-999.
Batch counter	65-66	04
	67-70	The batch counter information is four bytes long and specified by four ASCII digits. Range: 0000-9999.
Tightening Status	71-72	05

All messages

Parameter	Byte	Value
	73	The tightening status is one byte long and specified by one ASCII digit. 0=tightening NOK, 1=tightening OK.
Torque status	74-75	06
	76	0=Low, 1=OK, 2=High
Angle status	77-78	07
	79	0=Low, 1=OK, 2=High
Torque	80-81	08
	82-87	The torque value is multiplied by 100 and sent as an integer (2 decimals truncated). It is six bytes long and is specified by six ASCII digits.
Angle	88-89	09
	90-94	The turning angle value in degrees. Each turn represents 360 degrees. It is five bytes long and specified by five ASCII digits. Range: 00000-99999.
Time stamp	95-96	10
	97-115	Time stamp for the tightening. It is 19 bytes long and is specified by 19 ASCII characters (YYYY-MM-DD:HH:MM:SS).
Batch status	116-117	11
	118	The batch status is specified by one ASCII character. 0=batch NOK, 1=batch OK, 2=batch not used, 3=batch running

Table 124 MID 0065 Revision 2

Parameter	Byte	Value
Tightening ID	21-22	01
	23-32	The tightening ID is a unique ID for each tightening result. It is incremented after each tightening. 10 ASCII digits. Max 4294967295
VIN Number	33-34	02
	35-59	The VIN number is 25 bytes long and is specified by 25 ASCII characters.
Job ID	60-61	03
	62-65	The Job ID is four bytes long and specified by four ASCII digits. Range: 00-99
Parameter set ID	66-67	04
	68-70	The parameter set ID (Pset ID) is three bytes long and specified by three ASCII digits. Range: 000-999.
Strategy	71-72	05

Parameter	Byte	Value
	73-74	The strategies currently run by the controller. It is two bytes long and specified by two ASCII digits. Range: 00-99. The corresponding strategies are : 01=Torque control, 02=Torque control / angle monitoring, 03=Torque control / angle control AND, 04=Angle control / torque monitoring, 05=DS control, 06=DS control torque monitoring, 07=Reverse angle, 08=Reverse torque, 09=Click wrench, 10=Rotate spindle forward, 11=Torque control angle control OR, 12=Rotate spindle reverse, 13=Home position forward, 14=EP Monitoring, 15=Yield, 16=EP Fixed, 17=EP Control, 18=EP Angle shutoff, 19=Yield / torque control OR, 20=Snug gradient, 21=Residual torque / Time 22=Residual torque / Angle, 23=Breakaway peak 24=Loose and tightening, 25=Home position reverse, 26=PVT comp with Snug 99=No strategy
Strategy options	75-76	06
	77-81	Five bytes long bit field. Bit 0 Torque Bit 1 Angle Bit 2 Batch Bit 3 PVT Monitoring Bit 4 PVT Compensate Bit 5 Self-tap Bit 6 Rundown Bit 7 CM Bit 8 DS control Bit 9 Click Wrench Bit 10 RBW Monitoring
Batch size	82-83	07
	84-87	This parameter gives the total number of tightening in the batch. The batch size is four bytes long and specified by four ASCII digits. Range: 0000-9999.
Batch counter	88-89	08
	90-93	The batch counter information is four bytes long specifying and specified by four ASCII digits. Range: 0000-9999.
Tightening Status	94-95	09
	96	The tightening status is one byte long and is specified by one ASCII digit. 0=tightening NOK, 1=tightening OK.
Batch status	97-98	10
	99	The batch status is specified by one ASCII character. 0=batch NOK, 1=batch OK, 2=batch not used, 3=batch running
Torque status	100-101	11
	102	0=Low, 1=OK, 2=High

All messages

Parameter	Byte	Value
Angle status	103-104	12
	105	0=Low, 1=OK, 2=High
Rundown angle status	106-107	13
	108	0=Low, 1=OK, 2=High
Current Monitoring Status	109-110	14
	111	0=Low, 1=OK, 2=High
Self-tap status	112-113	15
	114	0=Low, 1=OK, 2=High
Prevail Torque monitoring status	115-116	16
	117	0=Low, 1=OK, 2=High
Prevail Torque compensate status	118-119	17
	120	0=Low, 1=OK, 2=High
Tightening error status	121-122	18
	123-132	<p>Ten bytes long bit field. Tightening error bits show what went wrong with the tightening.</p> <ul style="list-style-type: none"> Bit 1 Rundown angle max shut off Bit 2 Rundown angle min shut off Bit 3 Torque max shut off Bit 4 Angle max shut off Bit 5 Self-tap torque max shut off Bit 6 Self-tap torque min shut off Bit 7 Prevail torque max shut off Bit 8 Prevail torque min shut off Bit 9 Prevail torque compensate overflow Bit 10 Current monitoring max shut off Bit 11 Post view torque min torque shut off Bit 12 Post view torque max torque shut off Bit 13 Post view torque Angle too small Bit 14 Trigger lost Bit 15 Torque less than target Bit 16 Tool hot Bit 17 Multistage abort Bit 18 Rehit Bit 19 DS Measure failed Bit 20 Current limit reached Bit 21 End Time out shutoff Bit 22 Remove fastener limit exceeded Bit 23 Disable drive Bit 24 Transducer lost Bit 25 Transducer shorted Bit 26 Transducer corrupt Bit 27 Sync timeout Bit 28 Dynamic current monitoring min Bit 29 Dynamic current monitoring max Bit 30 Angle max monitor Bit 31 Yield nut off Bit 32 Yield too few samples
Torque	133-134	19
	135-140	The torque value is multiplied by 100 and sent as an integer (2 decimals truncated). It is six bytes long and is specified by six ASCII digits.

Parameter	Byte	Value
Angle	141-142	20
	143-147	The turning angle value in degrees. Each turn represents 360 degrees. It is five bytes long and specified by five ASCII digits. Range: 00000-99999.
Rundown angle	148-149	21
	150-154	The tightening angle value reached in degrees. Each turn represents 360 degrees. It is five bytes long and specified by five ASCII digits. Range: 00000-99999.
Current Monitoring Value	155-156	22
	157-159	The current monitoring value in percent is three bytes long and is specified by three ASCII digits. Range: 000-999.
Self-tap torque	160-161	23
	162-167	The self-tap torque is multiplied by 100 and sent as an integer (2 decimals truncated). It is six bytes long and specified by six ASCII digits.
Prevail torque	168-169	24
	170-175	The prevail torque value is multiplied by 100 and sent as an integer (2 decimals truncated). The prevail torque is six bytes long and is specified by six ASCII digits.
Job sequence number	176-177	25
	178-182	The Job sequence number is unique for each Job. All tightenings performed in the same Job are stamped with the same Job sequence number. It is specified by five ASCII digits. Range: 00000-65535.
Sync tightening ID	183-184	26
	185-189	The sync tightening ID is a unique ID for each sync tightening result. Each individual result of each spindle is stamped with this ID. The tightening ID is incremented after each sync tightening. It is specified by five ASCII digits. Range: 00000-65535.
Tool serial number	190-191	27
	192-205	The Tool serial number is specified by 14 ASCII characters.
Time stamp	206-207	28
	208-226	Time stamp for the tightening. It is 19 bytes long and is specified by 19 ASCII characters (YYYY-MM-DD:HH:MM:SS).

Table 125 MID 0065 Revision 3

Parameter	Byte	Value
Torque values Unit	227-228	29
	229	The unit in which the torque values are sent. The torque values unit is one byte long and is specified by one ASCII digit.

All messages

		1=Nm, 2=Lbf.ft, 3=Lbf.In, 4=Kpm 5=Kgf.cm, 6=ozf.in, 7=% , 8= Ncm
Result type	230-231	30
	232-233	The result type is two bytes long and specified by two ASCII digits. 1=Tightening, 2=Loosening, 3=Batch Increment, 4=Batch decrement, 5=Bypass parameter set result, 6=Abort Job result, 7=Sync tightening, 8=Reference setup, 9=Batch reset, 10=Job restart

Table 126 MID 0065 Revision 4

Parameter	Byte	Value
Identifier result part 2	234-235	31
	236-260	The identifier result part 2 is 25 bytes long and is specified by 25 ASCII characters.
Identifier result part 3	261-262	32
	263-287	The identifier result part 3 is 25 bytes long and is specified by 25 ASCII characters.
Identifier result part 4	288-289	33
	290-314	The identifier result part 4 is 25 bytes long and is specified by 25 ASCII characters.

Note: The identifier result parts will only be set if the multiple identifier option has been activated in the controller.

Table 127 MID 0065 Revision 5

Parameter	Byte	Value
Customer tightening error code	315-316	34
	317-320	The customer tightening error code is 4 byte long and is specified by 4 ASCII characters.

Table 128 MID 0065 Revision 6

Parameter	Byte	Value
Prevail Torque compensate value	321-322	35
	323-328	The PVT compensate torque value. It is multiplied by 100 and sent as an integer (2 decimals truncated). It is six bytes long and specified by six ASCII digits.
Tightening error status 2	329-330	36
	331-340	Bit field, Tightening error bits 2 shows what went wrong with the tightening. Bit 1 Drive deactivated Bit 2 Tool stall Bit 3 Drive hot Bit 4 Gradient monitoring high Bit 5 Gradient monitoring low Bit 6 Reaction bar failed Bit 7 Snug Max Bit 8 Cycle abort Bit 9 Necking failure Bit 10 Effective loosening Bit 11 Over speed Bit 12 No residual Torque

		Bit 13	Positioning fail
		Bit 14	Snug Mon. Low
		Bit 15	Snug Mon. High
		Bit 16	Dynamic Min. Current
		Bit 17	Dynamic Max. Current
		Bit 18	Latent result
		Bit 19-32	Reserved

Table 129 MID 0065 Revision 7

Parameter	Byte	Value
Station Id	341-342	37
	343-352	The station id is a unique id for each station. 10 ASCII digits. Max 4294967295
Station Name	353-354	38
	355-379	The station name is 25 bytes long and specified by 25 ASCII characters.

Table 130 MID 0065 Revision 8

Parameter	Byte	Value
Start final angle	380-381	39
	382-387	The start final angle is the torque to reach the snug level. The start final angle is multiplied by 100 and sent as an integer (2 decimals truncated). It is six bytes long and is specified by six ASCII digits.
Post view torque activated	388-389	40
	390	Post View Torque is On/Off 0=Off, 1=On, 2=Only PVTH on and 3=Only PVTL on
Post view torque high	391-392	41
	393-398	The post view torque high value. It is multiplied by 100 and sent as an integer (2 decimals truncated). It is six bytes long and specified by six ASCII digits.
Post view torque low	399-400	42
	401-406	The post view torque low value. It is multiplied by 100 and sent as an integer (2 decimals truncated). It is six bytes long and specified by six ASCII digits.

Table 131 MID 0065 Revision 9

Parameter	Byte	Value
Current Monitoring Amp	407-408	43
	409-413	The current monitoring value is multiplied by 100 and sent as an integer. It is five bytes long and specified by five ASCII digits. Range: 00000-99999. Value in Ampere Use blank space, when not used in implementation
Current Monitoring Amp Min	414-415	44
	416-420	The current monitoring min value is multiplied by 100 and sent as an integer. It is five bytes long and specified by five ASCII digits. Range: 00000-99999. Value in Ampere Use blank space, when not used in implementation
Current Monitoring Amp Max	421-422	45
	423-427	The current monitoring max value is multiplied by 100 and sent as an integer. It is five bytes long and specified by five ASCII digits. Range: 00000-99999. Value in Ampere Use blank space, when not used in implementation

Table 132 MID 0065 Revision 10

Parameter	Byte	Value
Angle numerator scale factor	428-429	46
	430-434	The scale factor defined by numerator / denominator applies on all angle values. Angle numerator scale factor is sent as an integer. It is five bytes long and specified by five ASCII digits. Range 00000-99999 Example: With 1/100 scale factor, angle value: 1.23° will be sent with value: 123
Angle denominator scale factor	435-436	47
	437-441	The scale factor defined by numerator / denominator applies on all angle values. Angle denominator scale factor is sent as an integer. It is five bytes long and specified by five ASCII digits. Range 00001-99999
Overall Angle Status	442-443	48
	444	Overall Angle is the total angle measured during the parameter set execution. OK when Overall Angle belongs to [Overall Angle Min ; Overall Angle Max] Low when Overall Angle < Overall Angle Min High when Overall Angle > Overall Angle Max 0=Low, 1=OK, 2=High
Overall Angle Min	445-446	49
	447-451	The overall angle min value in degrees. Each turn represents 360 degrees. It is five bytes long and specified by five ASCII digits. Range: -9999-99999. Note: Affected by angle scale factor.
Overall Angle Max	452-453	50
	454-458	The overall angle max value in degrees. Each turn represents 360 degrees. It is five bytes long and specified by five ASCII digits. Range: -9999-99999. Note: Affected by angle scale factor.
Overall Angle	459-460	51
	461-465	The overall angle value in degrees. Each turn represents 360 degrees. It is five bytes long and specified by five ASCII digits. Range: -9999-99999 Note: Affected by angle scale factor.
Peak Torque	466-467	52
	468-473	Peak Torque defines the highest torque value measured during the tightening. The peak torque value is multiplied by 100 and sent as an integer (2 decimals truncated). It is six bytes long and is specified by six ASCII digits.
Residual Breakaway Torque	474-475	53
	476-481	Residual Breakaway Torque defines the torque necessary to rotate the screw further. The breakaway torque value is multiplied by 100 and sent as an integer (2 decimals truncated). It is six bytes long and is specified by six ASCII digits.

All messages

Parameter	Byte	Value
Start Rundown angle	482-483	54
	484-489	The start rundown angle is the torque where the rundown angle monitoring starts. The start rundown angle is multiplied by 100 and sent as an integer (2 decimals truncated). It is six bytes long and is specified by six ASCII digits.
Rundown angle complete	490-491	55
	492-497	The rundown angle complete is the torque where the monitoring of rundown angle is stopped. The rundown angle complete is multiplied by 100 and sent as an integer (2 decimals truncated). It is six bytes long and is specified by six ASCII digits.

Table 133 MID 0065 Revision 11

Parameter	Byte	Value
Click torque	498-499	56
	500-505	The click torque value. It is multiplied by 100 and sent as an integer (2 decimals truncated). It is six bytes long and specified by six ASCII digits.
Click angle	506-507	57
	508-512	The click angle value. It is five bytes long and specified by five ASCII digits

Table 6 MID 0065 Revision 12

Parameter	Byte	Value
Selected Identifier Number	513-514	58
	515-518	The identifier number used to select the program is four bytes long and specified by four ASCII digits.
Click angle	519-520	59
	521-545	Joint ID assigned in the source tightening. Only the first 25 characters of the Joint ID are sent. It is 25 characters long and is specified by 25 characters.

Table 134 MID 0065 Revision 998

Note: Revision 998 is a continuation of Revision 6.

Parameter	Byte	Value
Number of stages in multistage	341-342	37
	343-344	The total number of stages to be run for this tightening. It is two bytes long and specified by two ASCII digits.
Number of stage results	345-346	38
	347-348	Number of run stages. It is two bytes long and specified by two ASCII digits. For each completed stage the final torque and the final angle are reported.

Parameter	Byte	Value
Stage result	349-350	39
	351- +11 x number of stage results	Byte 1-6: The stage torque value. The torque is multiplied by 100 and sent as an integer (2 decimals truncated). It is six bytes long and specified by six ASCII digits. Byte 7-11: The turning angle stage value in degrees. Each turn represents 360 degrees. It is five bytes long and specified by five ASCII digits. Range: 00000-99999.

5.8.7 MID 0066 Number of offline results

Number of results when offline. The following table show the revision available:

Message sent by: Controller
Answer: None

To request the data **MID 0006 Application data message request** without any extra data is used

For header description see section 2.2.2!

Table 135 MID 0066 Revision 1

Parameter	Byte	Value
Number of offline results	21-22	01
	23-24	2 ASCII digits. Max 99

Table 136 MID 0066 Revision 2

Parameter	Byte	Value
Number of offline results	21-22	01
	23-25	3 ASCII digits. Max 999
Number of offline curves	26-27	02
	28-30	3 ASCII digits. Max 999

5.8.8 MID 0067 Tightening Result List Upload

This message contains a list of tightening results stored in the controller. The result list is sorted ascendingly on result index, and contains a brief summary of each result.

MID 0006 Application Data Message Request shall be used for fetching this message

For full results data, request upload of MID 1201

5.8.8.1 Request for MID 0067 Extra Data

Use MID 0006 to request a MID 0067 upload. Table 137 shows the contents in the “extra data” field for this MID.

Table 137 MID 0067 Request extra data

Parameter	Size [byte]	Data type	Description
Start Index	10	UI	The oldest tightening result index to include in list. If equal to zero, result list will contain the most recent results.
Count	3	UI	The amount of tightening results requested. Uploaded list may contain fewer results. Also, different implementations might limit the maximum count supported, refer to the relevant implementation appendix.

5.8.8.2 Data field, MID 0067

Table 138 MID 0067 Tightening Result List Upload

Parameter	Size [byte]	Data type	Description			
Number of results	3	UI	The total number of tightening results in list.			
Result data	Number of results * 30		Parameter	Size [byte]	Data type	Description
			Index	10	UI	Index of tightening result.
			Start time	19	T	Start time for each tightening result. The time is 19 byte long and is specified by 19 ASCII characters (YYYY-MM-DD:HH:MM:SS)
			Status	1	UI	The total status of the operation. One byte long and is specified by one ASCII digit ('0' or '1'). 0=result NOK, 1=result OK.

5.8.9 MID 0900 Trace curve data message

This MID 0900 response contains all data from the trace curve that integrator has subscribed for except the plotting parameters that is sent in MID 0901

Message sent by: Controller
 Answer: **MID 0005 Command accepted**

The data fields contain all overall data necessary for identifying the trace result of a tightening. Table below descriptions the “Data field” that begins at byte 21 after the message header. All PID’s is to be described in Chapter “6.4 Parameter ID numbers”

Table 139 MID 900 Data field, revision 1

Parameter	Size [byte]	Data type	Description		
Result Data Identifier	10	UI	The Result Data Identifier is a unique ID for each operation result within the system.		
Time stamp	19	T	Time stamp for each operation sent to the control station. The time is 19 byte long and is specified by 19 ASCII characters (YYYY-MM-DD:HH:MM:SS)		
Number of PID’s (parameter data fields)	3	UI	The number of variable data fields in the telegram. If no data fields exist “000” will be sent. The parameters on this level are common for all traces.		
Data fields	Vary	This section is repeated “Number of data fields” times. If Number of data fields = 000, this section is not sent. . The structure of each Data field is of variable parameter type see Variable Data Field Use			
		Parameter	Size [byte]	Data type	Description
		Parameter id (PID).	5	UI	The available PID’s may vary depending on the system type. (see Parameter ID numbers)
		Length	3	UI	Length of data value.
		Data Type	2	UI	Data type of the data value. (see Data Type definitions)
		Unit	3	UI	Unit of the data.
		Step no.	4	UI	The step number for the trace result variable. Sent as 0000 if not relevant (stage Index)
		Data value	Length	Data Type	The data value.

Parameter	Size [byte]	Data type	Description			
Trace Type	2	UI	Type of the trace curve 1 = Angle trace 2 = Torque trace 3 = Current trace 4 = Gradient trace 5 = Stroke trace 6 = Force trace			
Transducer Type	2	UI	To identify the transducer used to produce the trace data for tools with multiple transducers. Sent as an integer value there 1 = transducer 1, 2 = transducer 2 etc.			
Unit	3	UI	Unit of trace curve, according to the table Units types (e.g. 001 = Nm etc.)			
Number of parameter data fields	3	UI	The number of variable data fields in the telegram. If no data fields exist "000" will be sent.			
Data fields	Vary		This section is repeated "Number of data fields" times. If Number of data fields = 000, this section is not sent. . The structure of each Data field is of variable parameter type see Variable Data Field Use			
Number of resolution fields	3	UI	The number of different resolutions fields in this telegram .If no data fields exist "000" will be sent.			
Resolution fields	Vary		This section is repeated Number of resolution fields. If Number of resolution fields = 000, this section is not sent. This field defines the time interval between two consecutive samples in the trace curve.			
			Parameter	Size [byte]	Data type	Description
			First index	5	UI	The first index in the trace data there this resolution is valid
			Last Index	5	UI	The last index in the trace data there this resolution is valid
			Length	3	UI	Length of the time value.
			Data Type	2	UI	Data type of the time value.
			Unit	3	UI	Unit of the time value.
			Time value	Length	Data Type	The time between two consecutive samples
Number of trace samples	5	UI	Number of samples in the trace			
NUL character	1	-	To separate text and binary a NUL character (0x00) is sent here.			
Trace sample	2	Binary	Repeated Number of trace samples times. Each point in the trace is sent as a 2 byte binary value. To calculate the physical values of the torque or angle trace data, it is needed to divide this values by the coefficient "K", parameter with PID 02213 in Data fields or bye doing multiplicity if PID 02214 is used.			

Table 140 MID 900 Data field, revision 2

Parameter	Size [byte]	Data type	Description		
Result Data Identifier	10	UI	The Result Data Identifier is a unique ID for each operation result within the system.		
Time stamp	19	T	Time stamp for each operation sent to the control station. The time is 19 byte long and is specified by 19 ASCII characters (YYYY-MM-DD:HH:MM:SS)		
Number of PID's (parameter data fields)	3	UI	The number of variable data fields in the telegram. If no data fields exist "000" will be sent. The parameters on this level are common for all traces.		
Data fields	Vary	This section is repeated "Number of data fields" times. If Number of data fields = 000, this section is not sent. . The structure of each Data field is of variable parameter type see Variable Data Field Use			
		Parameter	Size [byte]	Data type	Description
		Parameter id (PID).	5	UI	The available PID's may vary depending on the system type. (see Parameter ID numbers)
		Length	3	UI	Length of data value.
		Data Type	2	UI	Data type of the data value. (see Data Type definitions)
		Unit	3	UI	Unit of the data.
		Step no.	4	UI	The step number for the trace result variable. Sent as 0000 if not relevant (stage Index)
		Data value	Length	Data Type	The data value.

Parameter	Size [byte]	Data type	Description			
Trace Type	2	UI	Type of the trace curve 1 = Angle trace 2 = Torque trace 3 = Current trace 4 = Gradient trace 5 = Stroke trace 6 = Force trace			
Transducer Type	2	UI	To identify the transducer used to produce the trace data for tools with multiple transducers. Sent as an integer value there 1 = transducer 1, 2 = transducer 2 etc.			
Unit	3	UI	Unit of trace curve, according to the table Units types (e.g. 001 = Nm etc.)			
Request MID	4	UI	The MID of the request that this message is a response to. Typically 0008 (subscribe) or 0006 (data upload).			
Number of parameter data fields	3	UI	The number of variable data fields in the telegram. If no data fields exist "000" will be sent.			
Data fields	Vary		This section is repeated "Number of data fields" times. If Number of data fields = 000, this section is not sent. . The structure of each Data field is of variable parameter type see Variable Data Field Use			
Number of resolution fields	3	UI	The number of different resolutions fields in this telegram .If no data fields exist "000" will be sent.			
Resolution fields	Vary		This section is repeated Number of resolution fields. If Number of resolution fields = 000, this section is not sent. This field defines the time interval between two consecutive samples in the trace curve.			
			Parameter	Size [byte]	Data type	Description
			First index	5	UI	The first index in the trace data there this resolution is valid
			Last Index	5	UI	The last index in the trace data there this resolution is valid
			Length	3	UI	Length of the time value.
			Data Type	2	UI	Data type of the time value.
			Unit	3	UI	Unit of the time value.
			Time value	Length	Data Type	The time between two consecutive samples
Number of trace samples	5	UI	Number of samples in the trace			
NUL character	1	-	To separate text and binary a NUL character (0x00) is sent here.			
Trace sample	2	Binary	Repeated Number of trace samples times. Each point in the trace is sent as a 2 byte binary value. To calculate the physical values of the torque or angle trace data, it is needed to divide this values by the coefficient "K", parameter with PID 02213 in Data fields or bye doing multiplicity if PID 02214 is used.			

Table 141 MID 900 Data field, revision 3

Parameter	Size [byte]	Data type	Description			
Result Data Identifier	10	UI	The Result Data Identifier is a unique ID for each operation result within the system.			
Time stamp	19	T	Time stamp for each operation sent to the control station. The time is 19 byte long and is specified by 19 ASCII characters (YYYY-MM-DD:HH:MM:SS)			
Object ID	4	UI	The user defined object ID			
Object type	1	UI	0=Unknown 1=Dual Reading 2=Tightening Production 3=Tightening Simulation 4=Joint check 5=Dimensional			
Reference object ID	4	UI	Link to related Object ID			
Number of PID's (parameter data fields)	3	UI	The number of variable data fields in the telegram. If no data fields exist "000" will be sent. The parameters on this level are common for all traces.			
Data fields	Vary		This section is repeated "Number of data fields" times. If Number of data fields = 000, this section is not sent. . The structure of each Data field is of variable parameter type see Variable Data Field Use			
			Parameter	Size [byte]	Data type	Description
			Parameter id (PID).	5	UI	The available PID's may vary depending on the system type. (see Parameter ID numbers)
			Length	3	UI	Length of data value.
			Data Type	2	UI	Data type of the data value. (see Data Type definitions)
			Unit	3	UI	Unit of the data.
			Step no.	4	UI	The step number for the trace result variable. Sent as 0000 if not relevant (stage Index)
Data value	Length	Data Type	The data value.			

Parameter	Size [byte]	Data type	Description			
Trace Type	2	UI	Type of the trace curve 1 = Angle trace 2 = Torque trace 3 = Current trace 4 = Gradient trace 5 = Stroke trace 6 = Force trace			
Number of traces	2	UI	How many MID0901 graphs the controller will send.			
Transducer Type	2	UI	To identify the transducer used to produce the trace data for tools with multiple transducers. Sent as an integer value there 1 = transducer 1, 2 = transducer 2 etc.			
Unit	3	UI	Unit of trace curve, according to the table Units types (e.g. 001 = Nm etc.)			
Request MID	4	UI	The MID of the request that this message is a response to. Typically 0008 (subscribe) or 0006 (data upload).			
Number of parameter data fields	3	UI	The number of variable data fields in the telegram. If no data fields exist "000" will be sent.			
Data fields	Vary		This section is repeated "Number of data fields" times. If Number of data fields = 000, this section is not sent. . The structure of each Data field is of variable parameter type see Variable Data Field Use			
Number of resolution fields	3	UI	The number of different resolutions fields in this telegram .If no data fields exist "000" will be sent.			
Resolution fields	Vary		This section is repeated Number of resolution fields. If Number of resolution fields = 000, this section is not sent. This field defines the time interval between two consecutive samples in the trace curve.			
			Parameter	Size [byte]	Data type	Description
			First index	5	UI	The first index in the trace data there this resolution is valid
			Last Index	5	UI	The last index in the trace data there this resolution is valid
			Length	3	UI	Length of the time value.
			Data Type	2	UI	Data type of the time value.
			Unit	3	UI	Unit of the time value.
Time value	Length	Data Type	The time between two consecutive samples			
Number of trace samples	5	UI	Number of samples in the trace			
NUL character	1	-	To separate text and binary a NUL character (0x00) is sent here.			
Trace sample	2	Binary	Repeated Number of trace samples times. Each point in the trace is sent as a 2 byte binary value. To calculate the physical values of the torque or angle trace data, it is needed to divide this values by the coefficient "K", parameter with PID 02213 in Data fields or bye doing multiplicity if PID 02214 is used.			

All messages

The PID 02213, Coefficient, must be included in the message to be able to calculate the binary value, used for division.

OR

The PID 02214, Coefficient, must be included in the message to be able to calculate the binary value, used for multiplication.

Calculation example: Message sends a Torque trace that has unit Nm and a Coefficient = 100 (PID=02213 has Data value=100) the Trace sample value = 5610, this means that the Torque is 5610/100 means that torque is 56,1[Nm] or by PID = 02214 =5610 * 0,001.

Message example:

Sign | is not in message. Used only for increasing the readability.

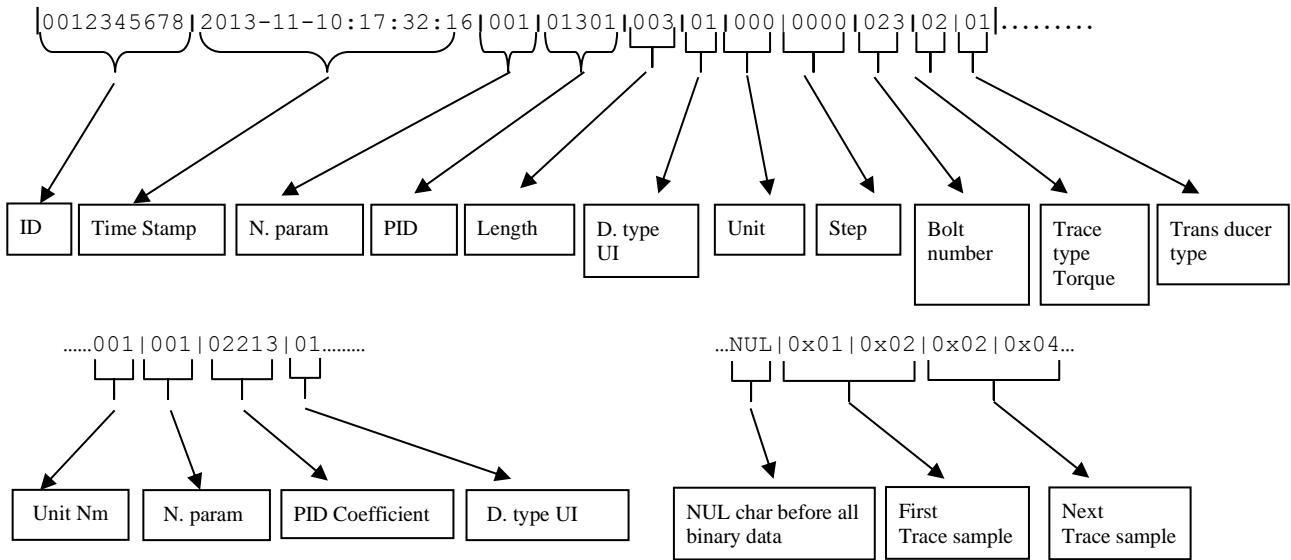

5.8.9.1 Request for MID 900 Extra Data

Use MID 0006 to request a MID 900 upload. Table 190 shows the contents in the “extra data” field for this MID.

Table 142 MID 900 Request extra data

Parameter	Size [byte]	Data type	Description
Index	10	UI	The index of the requested tightening result. If equal to zero, response will contain the most recent result.
Trace type	3	UI	Type of the trace requested. 1 = Angle trace 2 = Torque trace 3 = Current trace 4 = Gradient trace 5 = Stroke trace 6 = Force trace
Tool Number	4	UI	The number of the tool

5.8.9.2 Subscribe, MID 0900 Trace data message

Used by the integrator to subscribe on trace data. MID is used together with MID 0008, see Table 26 MID 0008, revision 1, this begins at byte 30 after the message header.

Message sent by: Integrator
 Answer: **MID 0005 Command accepted with MID 900 in the data field or
 MID 0004 Command error with MID 900 in the data field and error code,
 Subscription MID Revision unsupported or Subscription already exist or
 Subscription on specific data not supported or Invalid data**

Table 143 Extra data field for subscription MID 900, revision 1

Parameter	Size [byte]	Data type	Description
Send alternatives	1	UI	Following alternatives are available. One ASCII digit 0=Only new data, 1= Stored data from given index, 2 Stored data from given time stamp, 3 Stored data between two indexes, 4 Stored data between two given time stamps in Unix time (Seconds since 1970-01-01).. If = 0 then only the new data generated after the subscription is done is sent to the subscriber. Old unsent data will not be sent to the subscriber. If = 1 the data from given INDEX is sent inclusive the latest stored. If = 2 the data from given time stamp in Unix format is sent inclusive the latest stored. If = 3 the data between two given indexes is sent If = 4 the data between two given time stamps in Unix time is sent
			STRUCTURE FOR ALTERNATIVE 0-2
Data Identifier Time Stamp type	19	T	The identifier is a Time stamp of the requested data. The first data sent will be the first data and inclusive this time stamp and forward up to and inclusive the last one. If the data is not found, rewind will be to oldest possible data. All data from this point up to the newest available will be sent directly on subscribe. If not used filled in with zeroes e.g at alternative 1. At alternative 2 it contains the Time Stamp ex. 2015.10.01:19:01:30.
Data Identifier Index type or unix time type	10	UI	The Identifier INDEX or the UNIX time (at Alternative 2) of the data to rewind to. 10 bytes. Only used for old stored process data. The first data sent will be the data from and inclusive this point and forward up to and inclusive the last one. If the data is not found, or if the value is 0, rewind will be to oldest possible data. All data from this point up to the newest available will be sent directly on su
Number of trace types	2	UI	The number of trace types subscribed for
Trace type	3	UI	Type of the trace curve subscribed for. This field is repeated the Number of trace types. 1 = Angle trace 2 = Torque trace 3 = Current trace 4 = Gradient trace 5 = Stroke trace 6 = Force trace
			STRUCTURE FOR ALTERNATIVE 3

All messages

Data Identifier First index	10	UI	The first identifier is an index result id. The first data sent will be the first data, this index included. If the data is not found, there will be reported error. All data from this point up to the last given index will be sent directly on subscribe if found, else error.
Data Identifier Last Index	10	UI	The second Identifier is an index result id.
Number of trace types	2	UI	The number of trace types subscribed for
Trace type	3	UI	Type of the trace curve subscribed for. This field is repeated the Number of trace types. 1 = Angle trace 2 = Torque trace 3 = Current trace 4 = Gradient trace 5 = Stroke trace 6 = Force trace
			STRUCTURE FOR ALTERNATIVE 4
Data Identifier First Unix time	10	UI	The first identifier is an Unix time = Seconds since 1970-01-01. The first data sent will be the first data after this time. If the data is not found, there will be reported error. All data from this point up to the second given time will be sent directly on subscribe if found, else error.
Data Identifier Last Unix time	10	UI	The second Identifier is a Unix time.
Number of trace types	2	UI	The number of trace types subscribed for
Trace type	3	UI	Type of the trace curve subscribed for. This field is repeated the Number of trace types. 1 = Angle trace 2 = Torque trace 3 = Current trace 4 = Gradient trace 5 = Stroke trace 6 = Force trace

If the integrator tries to subscribe on a specific data that the controller doesn't support, the controller will replay with an error code MID 0004 Error 78 Subscription data not supported.

Error example: Parameter "Send only new data" is set to 2 and the controller doesn't support that, the controller will replay "MID 0004 Error 78 Subscription data not supported"

or

Parameter "Trace type" is set to 5 and the controller doesn't support that, the controller will replay "MID 0004 Error 78 Subscription data not supported"

Example: Subscribe on Angle Trace data, stored after that the subscription is done, using MID 0008 combined with MID 0900.

```
Send only new data=0,
Data Identifier Time Stamp type = N/A
Data Identifier Index type = N/A
Number of trace types = 01
```

Trace type = 001

<Data Field design>: MID[4];MIDRev[3];Length[2];ExtraData[2+n*3];NUL

<Header	><DataField	><NUL>
006400080010	0900001050	01001 NUL

The bold data is the data in the 'Extra Data Field' that begins at byte 30, and here it starts with a zero. This means that the subscription is set to send only new data. Then 29 spaces are sent since those fields are not needed and finally we have one trace of type Angle.

5.8.9.3 Unsubscribe, MID 0900 Trace curve data message

MID 0900 is used together with MID 0009 it will unsubscribe on trace data.

Message sent by: Integrator
 Answer: MID 0005 Command accepted with MID 900 in the data field or
 MID 0004 Command error with MID 900 in the data field with error code,
 Subscription not exist or Subscription on specific data not supported or Invalid
 data

Table below describe the parameter “Extra data” byte nr 30 in MID 0009 and is a part of the Data field. For a more detailed description see Table 27 MID 0009, revision 1

Example: Trace data message unsubscription on Angle using MID 0009

<Data Field design>: MID[4]; MIDRev[3]; Length[2]; **ExtraData**[2+n*3]; NUL

<Header	><Data Field	><NUL>
003400090010	09000010501001NUL	

Table 144 Extra data field for unsubscription MID 900, revision 1

Parameter	Size [byte]	Data type	Description
Number of trace types	2	UI	The number of trace types to unsubscribe
Trace type	3	UI	Type of the trace curve to unsubscribe. This field is repeated the Number of trace types. 1 = Angle trace 2 = Torque trace 3 = Current trace 4 = Gradient trace 5 = Stroke trace 6 = Force trace 999 = Unsubscribe on all

If unsubscribe is done on a specific trace type it automatically unsubscribes on the plotting data for that trace type as well.

5.8.10 MID 0901 Traces Plot Parameters Message

This MID contains all trace plotting parameters necessary for drawing of the limit figures in relation to the trace curve. The plotting parameters sent are dependent on the Trace types subscribed for. If both Torque and Angle trace are subscribed for also the Plot parameters for all possible limit figures will be sent

Message sent by: Controller
 Answer: MID 0005 Command accepted

5.8.10.1 Request for MID 901 Extra Data

Use MID 0006 to request a MID 901 upload. Table 194 shows the contents in the “extra data” field for this MID.

Table 145 MID 901 Request extra data

Parameter	Size [byte]	Data type	Description
Index	10	UI	The index of the requested tightening result. If equal to zero, response will contain the most recent result.
Trace type	3	UI	Type of the trace requested. 1 = Angle trace 2 = Torque trace 3 = Current trace 4 = Gradient trace 5 = Stroke trace 6 = Force trace
Tool Number	4	UI	The number of the tool

Table below descriptions the “Data field” that begins at byte 21 after the message header. All PID’s is to be described in Chapter “6.4 Parameter ID numbers”

Table 146 MID 901 data field, revision 1

Parameter	Size [byte]	Data type	Description
Result Data Identifier	10	UI	The Result Data Identifier is a unique ID for each operation result within the system.
Time stamp	19	T	Time stamp for each operation sent to the control station. The time is 19 byte long and is specified by 19 ASCII characters (YYYY-MM-DD:HH:MM:SS)
Number of PID’s (parameter data fields, specific)	3	UI	The number of variable data fields in the telegram. If no data fields exist “000” will be sent.
Data fields	Vary		This section is repeated “Number of data fields” times. If Number of data fields = 000, this section is not sent. . Each Data field structure is of variable parameter type see Variable Data Field Use

Table 147 MID 901 data field, revision 2

Parameter	Size [byte]	Data type	Description
Result Data Identifier	10	UI	The Result Data Identifier is a unique ID for each operation result within the system.
Time stamp	19	T	Time stamp for each operation sent to the control station. The time is 19 byte long and is specified by 19 ASCII characters (YYYY-MM-DD:HH:MM:SS)
Number of PID's (parameter data fields, specific)	3	UI	The number of variable data fields in the telegram. If no data fields exist "000" will be sent.
Request MID	4	UI	The MID of the request that this message is a response to. Typically 0008 (subscribe) or 0006 (data upload).
Data fields	Vary		This section is repeated "Number of data fields" times. If Number of data fields = 000, this section is not sent. . Each Data field structure is of variable parameter type see Variable Data Field Use

Table 148 MID 901 data field, revision 3

Parameter	Size [byte]	Data type	Description
Result Data Identifier	10	UI	The Result Data Identifier is a unique ID for each operation result within the system.
Time stamp	19	T	Time stamp for each operation sent to the control station. The time is 19 byte long and is specified by 19 ASCII characters (YYYY-MM-DD:HH:MM:SS)
Number of PID's (parameter data fields, specific)	3	UI	The number of variable data fields in the telegram. If no data fields exist "000" will be sent.
Request MID	4	UI	The MID of the request that this message is a response to. Typically 0008 (subscribe) or 0006 (data upload).
Object ID	4	UI	The user defined object ID
Object type	1	UI	0=Unknown 1=Dual Reading 2=Tightening Production 3=Tightening Simulation 4=Joint check 5=Dimensional
Reference object ID	4	UI	Link to related Object ID
Trace Type	2	UI	Type of the trace curve 1 = Angle trace 2 = Torque trace 3 = Current trace 4 = Gradient trace 5 = Stroke trace 6 = Force trace
Data fields	Vary		This section is repeated "Number of data fields" times. If Number of data fields = 000, this section is not sent. . Each Data field structure is of variable parameter type see Variable Data Field Use

Example: Subscription is made on plotting parameters. The controller will send plotting limits for Torque over time plane

LL	MID	Rev	N	ResDataId	TIMESTamp	NPI	PID	ll	DT	U	S.No	data value	
00xx	0009	001	0		000000001	YYYY-MM-DD:HH:MM:SS	00x	00000	000	00	000	0000	...	NUL

5.8.10.2 Subscribe, MID 0901 Trace plotting parameter

Used by the integrator to subscribe on trace data. MID 0901 is used together with MID 0008 Application data message subscription. No extra data is needed after the message header.

Message sent by: Integrator
Answer: **MID 0005 Command accepted with MID 901 in the data field** or
MID 0004 Command error with MID 901 in the data field and with error code, Subscription already exist or **Subscription does not exists** or **Invalid data**

The number of plotting parameters that is sent is according to respective Controller and according to what trace type that is subscribed for.

Example: If there Controller support Angle Trace and that trace type is subscribed for plus the plotting parameter, the Plotting limits for Angle vs. Time will be sent.

If there was no subscription on any trace type the controller will answer with **MID 0004 Command error Subscription does not exists.**

5.8.10.3 Unsubscribe, MID 0901 Trace plotting parameter

Used by the integrator to unsubscribe on trace data. MID 0901 is used together with MID 0009 Application Data Message unsubscribe. No extra data is needed after the message header.

Message sent by: Integrator
Answer: **MID 0005 Command accepted** or
MID 0004 Command error, Subscription not exist or **Invalid data**

5.8.11 MID 0902 Tightening Result DB Info Upload

This message contains information concerning the tightening result database on the controller.

Mid 0006 Application Data Message Request shall be used for fetching this message

5.8.11.1 Request for MID 0902 Extra Data

Use MID 0006 to request a MID 0902 upload. The extra data shall be empty.

5.8.11.2 Data field, MID 0902

Table 149 MID 0902 Data field, revision 1

Parameter	Size [byte]	Data type	Description																								
Capacity	10	UI	The total number of tightening results that can be stored.																								
Oldest sequence number	10	UI	The sequence number of the oldest tightening result currently in the database																								
Oldest time	19	T	The start time of the oldest tightening result currently in the database																								
Newest sequence number	10	UI	The sequence number of the newest tightening result currently in the database																								
Newest time	19	T	The start time of the newest tightening result currently in the database																								
Number of PID's (parameter data fields)	3	UI	The number of variable data fields in the telegram. If no data fields exist "000" shall be sent.																								
Data fields	Vary		<p>This section is repeated "Number of data fields" times. If Number of data fields = 000, this section is not sent. The structure of each Data field is of variable parameter type see Variable Data Field Use</p> <table border="1"> <thead> <tr> <th>Parameter</th> <th>Size [byte]</th> <th>Data type</th> <th>Description</th> </tr> </thead> <tbody> <tr> <td>Parameter id (PID).</td> <td>5</td> <td>UI</td> <td>The available PID's may vary depending on the system type. (see Parameter ID numbers)</td> </tr> <tr> <td>Length</td> <td>3</td> <td>UI</td> <td>Length of data value.</td> </tr> <tr> <td>Data Type</td> <td>2</td> <td>UI</td> <td>Data type of the data value. (see Data Type definitions)</td> </tr> <tr> <td>Unit</td> <td>3</td> <td>UI</td> <td>Unit of the data.</td> </tr> <tr> <td>Data value</td> <td>Length</td> <td>Data Type</td> <td>The data value.</td> </tr> </tbody> </table>	Parameter	Size [byte]	Data type	Description	Parameter id (PID).	5	UI	The available PID's may vary depending on the system type. (see Parameter ID numbers)	Length	3	UI	Length of data value.	Data Type	2	UI	Data type of the data value. (see Data Type definitions)	Unit	3	UI	Unit of the data.	Data value	Length	Data Type	The data value.
Parameter	Size [byte]	Data type	Description																								
Parameter id (PID).	5	UI	The available PID's may vary depending on the system type. (see Parameter ID numbers)																								
Length	3	UI	Length of data value.																								
Data Type	2	UI	Data type of the data value. (see Data Type definitions)																								
Unit	3	UI	Unit of the data.																								
Data value	Length	Data Type	The data value.																								

5.9 Application result messages with variables

These result data MIDs allow for step data to be sent, as well as most other available result variables.

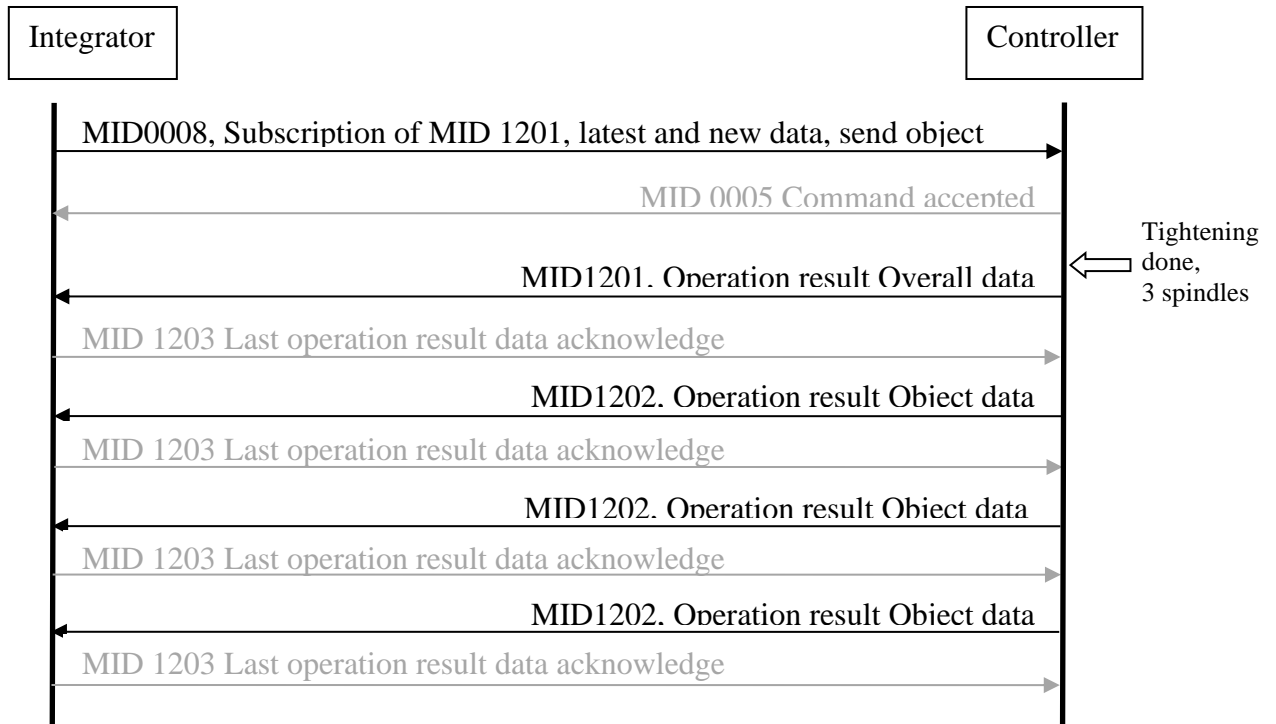

5.9.1 MID 1201 Operation result Overall data

This MID contains the overall result data and some of the object data of the last tightening. In the subscription of this message it can be chosen to also start subscription of MID 1202 Operation result object data. The user defined values is preconfigured in the controller via the configuration tool.

Message sent by: Controller

Answer: MID 1203 Operation result data acknowledge or MID 0005 with MID 1201 in the data field. If the sequence number acknowledge functionality is used there is no need for these acknowledges.

5.9.1.1 Request for MID 1201 Extra Data

Use MID 0006 to request a MID 1201 upload. Table 150 shows the contents in the “extra data” field for this MID. Requesting an upload of MID 1201 will also result in one or more MID 1202 uploads.

Table 150 MID 1201 Request extra data

Parameter	Size [byte]	Data type	Description
Index	10	UI	The index of the requested tightening result. If equal to zero, response will contain the most recent result.

5.9.1.2 Subscription, MID 1201

Use MID 0008 to start subscription, Table 151 shows the content in the “Extra data” field.

Table 151 MID 1201, Subscription “Extra data” field included in MID 0008, rev 001.

Parameter	Size [byte]	Data type	Description
Send alternatives	1	UI	<p>Following alternatives are available.</p> <p>One ASCII digit 0=Only new data, 1= Stored data from given index, 2 Stored data from given time stamp, 3 Stored data between two indexes, 4 Stored data between two given time stamps in Unix time (Seconds since 1970-01-01)..</p> <p>If = 0 then only the last data stored and data stored after that the subscription is done is sent to the subscriber. Old unsent data will not be sent to the subscriber.</p> <p>If = 1 the data from given INDEX is sent inclusive the latest stored.</p> <p>If = 2 the data from given time stamp in Unix format is sent inclusive the latest stored.</p> <p>If = 3 the data between two given indexes is sent</p> <p>If = 4 the data between two given time stamps in Unix time is sent</p>
			STRUCTURE FOR ALTERNATIVE 0-2

All messages

Data Identifier Time Stamp type	19	T	The identifier is a Time stamp of the requested data. The first data sent will be the first data and inclusive this time stamp and forward up to and inclusive the last one. If the data is not found, rewind will be to oldest possible data. All data from this point up to the newest available will be sent directly on subscribe. If not used filled in with zeroes e.g at alternative 1. At alternative 2 it contains the Time Stamp ex. 2015.10.01:19:01:30.
Data Identifier Index type or unix time type	10	UI	The Identifier INDEX or the UNIX time (at Alternative 2) of the data to rewind to. 10 bytes. Only used for old stored process data. The first data sent will be the data from and inclusive this point and forward up to and inclusive the last one. If the data is not found, or if the value is 0, rewind will be to oldest possible data. All data from this point up to the newest available will be sent directly on subscribe.
Send object data	1	B	Start subscription of MID 1202. It is not possible to only start subscription of MID 1202 without a subscription of MID 1201.
			STRUCTURE FOR ALTERNATIVE 3
Data Identifier First index	10	UI	The first identifier is an index result id. The first data sent will be the first data, this index included. If the data is not found, there will be reported error. All data from this point up to the last given index will be sent directly on subscribe if found, else error.
Data Identifier Last Index	10	UI	The second Identifier is an index result id.
Send object data	1	B	Start subscription of MID 1202. It is not possible to only start subscription of MID 1202 without a subscription of MID 1201.
			STRUCTURE FOR ALTERNATIVE 4
Data Identifier First Unix time	10	UI	The first identifier is an Unix time = Seconds since 1970-01-01. The first data sent will be the first data after this time. If the data is not found, there will be reported error. All data from this point up to the second given time will be sent directly on subscribe if found, else error.
Data Identifier Last Unix time	10	UI	The second Identifier is a Unix time.
Send object data	1	B	Start subscription of MID 1202. It is not possible to only start subscription of MID 1202 without a subscription of MID 1201.

Message sent by: Integrator

Answer: MID 0005 Command accepted with MID 1201 in the data field or

MID 0004 Command error with MID 1201 in the data field with error code, Subscription on specific data not supported or Invalid data.

After a MID 0005 the last stored data is sent from the Controller to the Integrator in addition.

5.9.1.3 Unsubscription, MID 1201

Use MID 0009 to unsubscribe. No "Extra data" field is needed.

5.9.1.4 Data field, MID 1201

Table 152 MID 1201 Data, revision 1

Parameter	Size [byte]	Data type	Description												
Total no of messages	3	UI	The total number of messages needed to send all data for all tools/screws in the tightening. The rest of the messages are of type MID 1202 Operation result object data, one message for each object.												
Message number	3	UI	This parameter is always 001 as this is the first message.												
Result Data Identifier	10	UI	The Result Data Identifier is a unique ID for each operation result within the system.												
Time	19	T	Cycle start time for each operation sent to the control station. The time is 19 byte long and is specified by 19 ASCII characters (YYYY-MM-DD:HH:MM:SS)												
Result status	1	UI	The total status of the operation. One byte long and is specified by one ASCII digit ('0' or '1'). 0=cycle NOK, 1=cycle OK.												
Operation type	2	UI	Operation type: 0=Non synchronized tightening, i.e. a hand tool 1=Synchronized tightening, i.e. a fixture multiple 2=Pressing 3=Drilling 4=Pulse												
Number of objects	3	UI	The total number of objects in the operation The object part in this message is repeated Number of objects times.												
Object data	Number of objects * 5		<table border="1"> <thead> <tr> <th>Parameter</th> <th>Size [byte]</th> <th>Data type</th> <th>Description</th> </tr> </thead> <tbody> <tr> <td>Object Id</td> <td>4</td> <td>UI</td> <td>The user defined Object Id.</td> </tr> <tr> <td>Object Status</td> <td>1</td> <td>UI</td> <td>Specified by one ASCII digit. 0=NOK, 1=OK</td> </tr> </tbody> </table>	Parameter	Size [byte]	Data type	Description	Object Id	4	UI	The user defined Object Id.	Object Status	1	UI	Specified by one ASCII digit. 0=NOK, 1=OK
		Parameter	Size [byte]	Data type	Description										
		Object Id	4	UI	The user defined Object Id.										
Object Status	1	UI	Specified by one ASCII digit. 0=NOK, 1=OK												
Number of data fields	3	UI	The number of variable data fields in the telegram. If no data fields exist "000" will be sent.												
Data fields	Vary		This section is repeated Number of data fields times. If Number of data fields = 000, this section is not sent. The structure is of variable parameter type see Variable Data Field Use												
<p>Note: It is NOT allowed to use the 'Data values' fields of this telegram to send data that are spindle/bolt/controller specific. If ANY data of this type is wanted the telegram 1202 MUST be used instead. If spindle/bolt/controller specific data is sent in 1201 the telegram will not be compatible between single and multiple tightenings and this is not good. Also there is a mandatory to include variable data fields of parameters for the oldest and the last INDEX and the oldest and the last TIME STAMPS. See specific controller documents.</p>															

Table 153 MID 1201 Data, revision 2

Parameter	Size [byte]	Data type	Description												
Total no of messages	3	UI	The total number of messages needed to send all data for all tools/screws in the tightening. The rest of the messages are of type MID 1202 Operation result object data, one message for each object.												
Message number	3	UI	This parameter is always 001 as this is the first message.												
Result Data Identifier	10	UI	The Result Data Identifier is a unique ID for each operation result within the system.												
Time	19	T	Cycle start time for each operation sent to the control station. The time is 19 byte long and is specified by 19 ASCII characters (YYYY-MM-DD:HH:MM:SS)												
Result status	1	UI	The total status of the operation. One byte long and is specified by one ASCII digit ('0' or '1'). 0=cycle NOK, 1=cycle OK.												
Operation type	2	UI	Operation type: 0=Non synchronized tightening, i.e. a hand tool 1=Synchronized tightening, i.e. a fixture multiple 2=Pressing 3=Drilling 4=Pulse												
Request MID	4	UI	The MID of the request that this message is a response to. Typically 0008 (subscribe) or 0006 (data upload).												
Number of objects	3	UI	The total number of objects in the operation The object part in this message is repeated Number of objects times.												
Object data	Number of objects * 5		<table border="1"> <thead> <tr> <th>Parameter</th> <th>Size [byte]</th> <th>Data type</th> <th>Description</th> </tr> </thead> <tbody> <tr> <td>Object Id</td> <td>4</td> <td>UI</td> <td>The user defined Object Id.</td> </tr> <tr> <td>Object Status</td> <td>1</td> <td>UI</td> <td>Specified by one ASCII digit. 0=NOK, 1=OK</td> </tr> </tbody> </table>	Parameter	Size [byte]	Data type	Description	Object Id	4	UI	The user defined Object Id.	Object Status	1	UI	Specified by one ASCII digit. 0=NOK, 1=OK
			Parameter	Size [byte]	Data type	Description									
			Object Id	4	UI	The user defined Object Id.									
Object Status	1	UI	Specified by one ASCII digit. 0=NOK, 1=OK												
Number of data fields	3	UI	The number of variable data fields in the telegram. If no data fields exist "000" will be sent.												
Data fields	Vary		This section is repeated Number of data fields times. If Number of data fields = 000, this section is not sent. The structure is of variable parameter type see Variable Data Field Use												
<p>Note: It is NOT allowed to use the 'Data values' fields of this telegram to send data that are spindle/bolt/controller specific. If ANY data of this type is wanted the telegram 1202 MUST be used instead. If spindle/bolt/controller specific data is sent in 1201 the telegram will not be compatible between single and multiple tightenings and this is not good. Also there is a mandatory to include variable data fields of parameters for the oldest and the last INDEX and the oldest and the last TIME STAMPS. See specific controller documents.</p>															

Table 154 MID 1201 Data, revision 3

Parameter	Size [byte]	Data type	Description																				
Total no of messages	3	UI	The total number of messages needed to send all data for all tools/screws in the tightening. The rest of the messages are of type MID 1202 Operation result object data, one message for each object.																				
Message number	3	UI	This parameter is always 001 as this is the first message.																				
Result Data Identifier	10	UI	The Result Data Identifier is a unique ID for each operation result within the system.																				
Time	19	T	Cycle start time for each operation sent to the control station. The time is 19 byte long and is specified by 19 ASCII characters (YYYY-MM-DD:HH:MM:SS)																				
Result status	1	UI	The total status of the operation. One byte long and is specified by one ASCII digit ('0' or '1'). 0=cycle NOK, 1=cycle OK.																				
Operation type	2	UI	Operation type: 0=Non synchronized tightening, i.e. a hand tool 1=Synchronized tightening, i.e. a fixture multiple 2=Pressing 3=Drilling 4=Pulse																				
Request MID	4	UI	The MID of the request that this message is a response to. Typically 0008 (subscribe) or 0006 (data upload).																				
Number of objects	3	UI	The total number of objects in the operation The object part in this message is repeated Number of objects times.																				
Object data	Number of objects * 10		<table border="1"> <thead> <tr> <th>Parameter</th> <th>Size [byte]</th> <th>Data type</th> <th>Description</th> </tr> </thead> <tbody> <tr> <td>Object Id</td> <td>4</td> <td>UI</td> <td>The user defined Object Id.</td> </tr> <tr> <td>Object Status</td> <td>1</td> <td>UI</td> <td>Specified by one ASCII digit. 0=NOK, 1=OK</td> </tr> <tr> <td>Object type</td> <td>1</td> <td>UI</td> <td>0=Unknown 1=Dual Reading 2=Tightening Production 3=Tightening Simulation 4=Joint check 5=Dimensional</td> </tr> <tr> <td>Reference object ID</td> <td>4</td> <td>UI</td> <td>Link to related object ID</td> </tr> </tbody> </table>	Parameter	Size [byte]	Data type	Description	Object Id	4	UI	The user defined Object Id.	Object Status	1	UI	Specified by one ASCII digit. 0=NOK, 1=OK	Object type	1	UI	0=Unknown 1=Dual Reading 2=Tightening Production 3=Tightening Simulation 4=Joint check 5=Dimensional	Reference object ID	4	UI	Link to related object ID
		Parameter	Size [byte]	Data type	Description																		
		Object Id	4	UI	The user defined Object Id.																		
		Object Status	1	UI	Specified by one ASCII digit. 0=NOK, 1=OK																		
		Object type	1	UI	0=Unknown 1=Dual Reading 2=Tightening Production 3=Tightening Simulation 4=Joint check 5=Dimensional																		
Reference object ID	4	UI	Link to related object ID																				
Number of data fields	3	UI	The number of variable data fields in the telegram. If no data fields exist "000" will be sent.																				
Data fields	Vary		This section is repeated Number of data fields times. If Number of data fields = 000, this section is not sent. The structure is of variable parameter type see Variable Data Field Use																				
<p>Note: It is NOT allowed to use the 'Data values' fields of this telegram to send data that are spindle/bolt/controller specific. If ANY data of this type is wanted the telegram 1202 MUST be used instead. If spindle/bolt/controller specific data is sent in 1201 the telegram will not be compatible between single and multiple tightenings and this is not good. Also there is a mandatory to include variable data fields of parameters for the oldest and the last INDEX and the oldest and the last TIME STAMPS. See specific controller documents.</p>																							

5.9.2 MID 1202 Operation result object data

This message contains the cycle data for one object, both data for the whole process and data related to the different steps in the process. The user defined values are preconfigured in the controller via the configuration tool. The message uses the Variable Parameter pattern for transmission of the values.

Note: Only values that exist in the result will be sent. So the actual data received may vary between the cycles if the settings differ between different programs.

Message sent by: Controller

Answer: MID 1203 Operation result data acknowledge or MID 0005 with MID 1202 in the data field. If the sequence number acknowledge functionality is used there is no need for these acknowledges.

5.9.2.1 Subscription, on MID1202

Start subscription of MID1201 and set the "Send object data"=TRUE.

5.9.2.2 Unsubscribe, on MID1202

To unsubscribe on this mid you need to unsubscribe on MID 1201.

5.9.2.3 Data field, MID 1202

Table 155 MID 1202, revision 1

Parameter	Size [byte]	Data type	Value
Total no of messages	3	UI	The total number of messages needed to send all object data for all objects, including message MID 1201 Last operation result Overall data, sent with the station data. One message MID 1202 Last operation result Object data is sent for each Bolt.
Message number	3	UI	This number counts from 002 to Total no of messages and is incremented by 1 for each sent message. The first Bolt message is message number 002, since MID 1201 Operation result Overall data is number 001. 3 ASCII digits, range 002-999.
Result Data Identifier	10	UI	The Result Data Identifier is a unique ID for each object result within the system. Will always match the Result identifier sent in MID 1201 Last operation result Overall data.
Object Id	4	UI	The user defined Object Id.
Number of data fields	3	UI	The number of variable data fields in the telegram. Format: ASCII digits. If no values exist "000" will be sent.
Data fields	Vary		This section is repeated Number of data fields times. If Number of data fields = 000, this section is not sent. The structure is of variable parameter type see Variable Data Field Use

Table 156 MID 1202, revision 2

Parameter	Size [byte]	Data type	Value
Total no of messages	3	UI	The total number of messages needed to send all object data for all objects, including message MID 1201 Last operation result Overall data, sent with the station data. One message MID 1202 Last operation result Object data is sent for each Bolt.
Message number	3	UI	This number counts from 002 to Total no of messages and is incremented by 1 for each sent message. The first Bolt message is message number 002, since MID 1201 Operation result Overall data is number 001. 3 ASCII digits, range 002-999.
Result Data Identifier	10	UI	The Result Data Identifier is a unique ID for each object result within the system. Will always match the Result identifier sent in MID 1201 Last operation result Overall data.
Object Id	4	UI	The user defined Object Id.
Node GUID	36	UI	The user defined node GUID
Number of data fields	3	UI	The number of variable data fields in the telegram. Format: ASCII digits. If no values exist "000" will be sent.
Data fields	Vary		This section is repeated Number of data fields times. If Number of data fields = 000, this section is not sent. The structure is of variable parameter type see Variable Data Field Use

If system is not sync (Flex of StepSync) then Joint ID will be sent as Bolt name with parameter ID 01300 if a Joint ID is used (non-empty).

5.9.3 MID 1203 Operation result data acknowledge

Message sent by: Integrator

Answer: None

Only Header is sent with no data fields.

5.9.4 Examples

All the examples below assume a subscription on MID 1201 Operation result Overall data has first been made. In the subscription it is assumed Send object data is set.

Hand tool

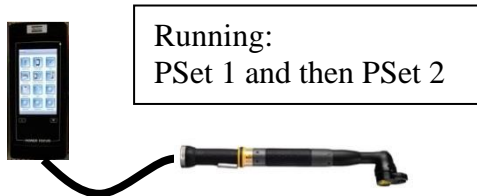

Telegrams sent

Controller

- MID 1201 Operation result Overall data** ←
Total no of messages = 2
Message number = 1
Number of objects = 1

- MID 1202 Operation result Object data** ←
Total no of messages = 2
Message number = 2

- MID 1201 Operation result Overall data** ←
Total no of messages = 2
Message number = 1
Number of objects = 1

- MID 1202 Operation result Object data** ←
Total no of messages = 2
Message number = 2

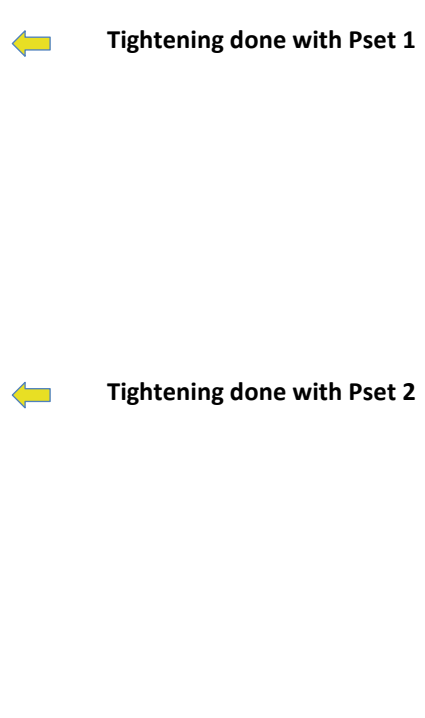

Hand tool running batch

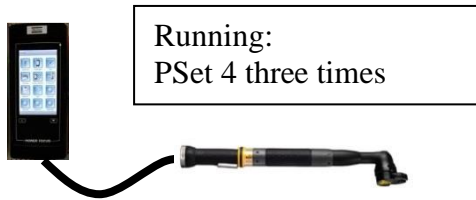

Telegrams sent

Controller

MID 1201 Operation result Overall data ←

Total no of messages = 2
Message number = 1
Number of objects = 1

MID 1202 Operation result Object data ←

Total no of messages = 2
Message number = 2

MID 1201 Operation result Overall data ←

Total no of messages = 2
Message number = 1
Number of objects = 1

MID 1202 Operation result Object data ←

Total no of messages = 2
Message number = 2

MID 1201 Operation result Overall data ←

Total no of messages = 2
Message number = 1
Number of objects = 1

MID 1202 Operation result Object data ←

Total no of messages = 2
Message number = 2

← Tightening done with Pset 4

← Tightening done with Pset 4

← Tightening done with Pset 4

Multiple with 4 spindles

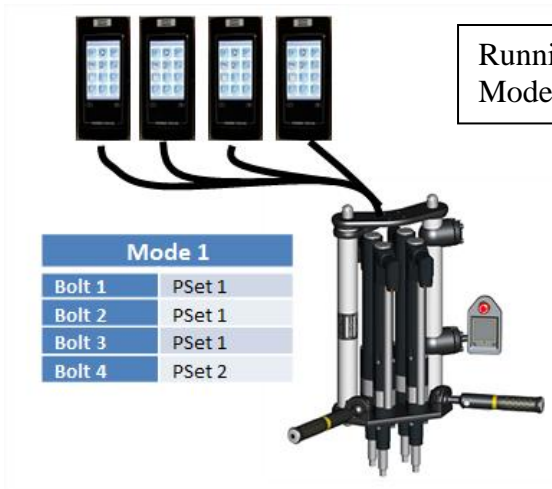

Telegrams sent

Controller

MID 1201 Operation result Overall data ←

Total no of messages = 5
Message number = 1
Number of objects = 4

MID 1202 Operation result Object data ←

Total no of messages = 5
Message number = 2
Object Id = 0001

MID 1202 Operation result Object data ←

Total no of messages = 5
Message number = 3
Object Id = 0002

MID 1202 Operation result Object data ←

Total no of messages = 5
Message number = 4
Object Id = 0003

MID 1202 Operation result Object data ←

Total no of messages = 5
Message number = 5
Object Id = 0004



Tightening done with Mode 1

Multiple with 2 spindles running batch

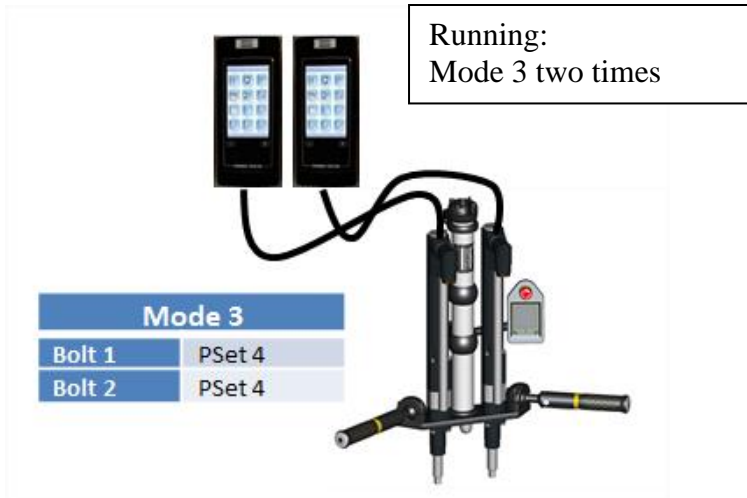

Telegrams sent

Controller

- MID 1201 Operation result Overall data** ←
 - Total no of messages = 3
 - Message number = 1
 - Number of objects = 2
- MID 1202 Operation result Object data** ←
 - Total no of messages = 3
 - Message number = 2
 - Object Id = 0001
- MID 1202 Operation result Object data** ←
 - Total no of messages = 3
 - Message number = 3
 - Object Id = 0002
- MID 1201 Operation result Overall data** ←
 - Total no of messages = 3
 - Message number = 1
 - Number of objects = 2
- MID 1202 Operation result Object data** ←
 - Total no of messages = 3
 - Message number = 2
 - Object Id = 0001
- MID 1202 Operation result Object data** ←
 - Total no of messages = 3
 - Message number = 3
 - Object Id = 0002

← Tightening done with Mode 3

← Tightening done with Mode 3



Running:
Measurement with
Verification Program two times

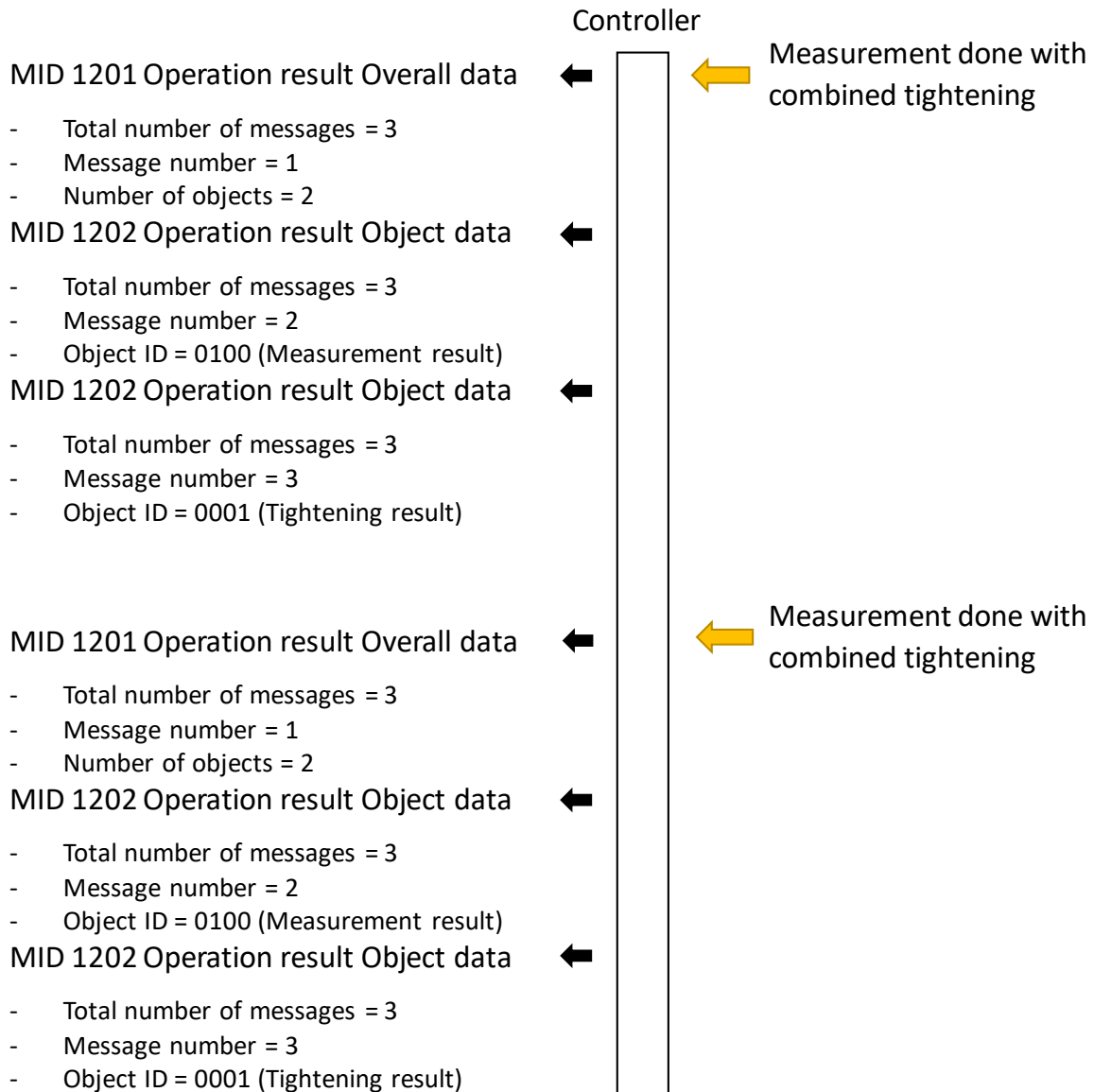

5.10 Application Alarm messages

5.10.1 MID 0070 Alarm subscribe

A subscription for the alarms that can appear in the controller.

Message sent by: Integrator
 Answer: **MID 0005 Command accepted** or
MID 0004 Command error, Alarm subscription already exists

For header description see section 2.2.2!

5.10.2 MID 0071 Alarm

An alarm has appeared in the controller. The current alarm is uploaded from the controller to the integrator.

Message sent by: Controller
 Answer: **MID 0072 Alarm acknowledge**

Example: MID 0071. Alarm E404 appeared on June 12, 2008. The controller and the tool have ready status.

00530071	01E404021031042008-06-02:10:14:26NUL
----------	--------------------------------------

For header description see section 2.2.2!

Table 157 MID 0071 Alarm data revision 0-1

Parameter	Byte	Value
Error code	21-22	01
	23-26	The error code is specified by 4 ASCII characters. Example E851 or 1010.
Controller ready status	27-28	02
	29	Controller ready status 1=OK, 0=NOK
Tool ready status	30-31	03
	32	Tool ready status 1=OK, 0=NOK
Time	33-34	04
	35-53	Time stamp for the alarm. 19 ASCII characters. YYYY-MM-DD:HH:MM:SS

Table 158 MID 0071 Alarm data revision 2

Parameter	Byte	Value
Error code	21-22	01
	23-27	The error code is specified by 5 ASCII characters. But doesn't have to be five characters long, not used characters are replaced with space or according to application specific appendix. Example E1021.
Controller ready status	28-29	02
	30	Controller ready status 1=OK, 0=NOK
Tool ready status	31-32	03
	33	Tool ready status 1=OK, 0=NOK
Time	34-35	04
	36-54	Time stamp for the alarm. 19 ASCII characters. YYYY-MM-DD:HH:MM:SS

Table 159 MID 0071 Alarm data revision 3

Parameter	Byte	Value
Tool health	55-56	05
	57	Tells the status of the tool. See device specific documentation for examples. 0=Tool Health not applicable, 1=Tool Health is OK, 2=Tool Health is NOK
Alarm text	58-59	06
	60-110	Alarm text. 50 ASCII characters

5.10.3 MID 0072 Alarm acknowledge

Acknowledgement for **MID 0071 Alarm**.

Message sent by: Integrator

Answer: None

For header description see section 2.2.2!

5.10.4 MID 0073 Alarm unsubscribe

Reset the subscription for the controller alarms.

Message sent by: Integrator

Answer: **MID 0005 Command accepted** or
MID 0004 Command error, Alarm subscription does not exist

For header description see section 2.2.2!

5.10.5 MID 0074 Alarm acknowledged on controller

The message is sent by the controller to inform the integrator that the current alarm has been acknowledged.

Message sent by: Controller
 Answer: **MID 0075 Alarm acknowledged on controller acknowledge**

Example: MID 0074 Alarm E406 acknowledged on controller.

00240074	E406NUL
----------	---------

For header description see section 2.2.2!

Table 160 MID 0074 Alarm acknowledged revision 1

Parameter	Byte	Value
Error code	21-24	Four ASCII characters

Table 161 MID 0074 Alarm acknowledged revision 2

Parameter	Byte	Value
Error code	21-25	Five ASCII characters

5.10.6 MID 0075 Alarm acknowledged on controller acknowledge

Acknowledgement of **MID 0074 Alarm acknowledged on controller**.

Message sent by: Integrator
 Answer: None

For header description see section 2.2.2!

5.10.7 MID 0076 Alarm status

The alarm status is sent after an accepted subscription of the controller alarms. This message is used to inform the integrator that an alarm is active on the controller at subscription time.

Message sent by: Controller
 Answer: **MID 0077 Alarm status acknowledge**

Example: MID 0076. Alarm E404 is active, the controller and the tool are ready.

00560076	01102E404031041052008-06-02:10:14:26NUL
----------	---

For header description see section 2.2.2!

Table 162 MID 0076 Alarm status data Rev 1

Parameter	Byte	Value
Alarm status	21-22	01
	23	0=no alarm is active, 1=an alarm is currently active
Error code	24-25	02
	26-29	The error code is specified by 4 ASCII characters. Example E851 or 1010.
Controller ready status	30-31	03
	32	Controller ready status 1=OK, 0=NOK
Tool ready status	33-34	04
	35	Tool ready status 1=OK, 0=NOK
Time	36-37	05
	38-56	Time stamp for the alarm. 19 ASCII characters. YYYY-MM-DD:HH:MM:SS

Table 163 MID 0076 Alarm status data Rev 2

Parameter	Byte	Value
Alarm status	21-22	01
	23	0=no alarm is active, 1=an alarm is currently active
Error code	24-25	02
	26-30	The error code is specified by 5 ASCII characters. But doesn't have to be five characters long, not used characters are replaced with space or according to application specific appendix. Example E1021.
Controller ready status	31-32	03
	33	Controller ready status 1=OK, 0=NOK
Tool ready status	34-35	04
	36	Tool ready status 1=OK, 0=NOK
Time	37-38	05
	39-57	Time stamp for the alarm. 19 ASCII characters. YYYY-MM-DD:HH:MM:SS

Table 164 MID 0076 Alarm status data Rev 3

Parameter	Byte	Value
Tool health	58-59	06
	60	Tells the status of the tool. See device specific documentation for examples. 0=Tool Health not applicable, 1=Tool Health is OK, 2=Tool Health is NOK

5.10.8 MID 0077 Alarm status acknowledge

Acknowledgement of **MID 0076 Alarm Status**.

Message sent by: Integrator
Answer: None

For header description see section 2.2.2!

5.10.9 MID 0078 Acknowledge alarm remotely on controller

The integrator can remotely acknowledge the current alarm on the controller by sending **MID 0078**. If no alarm is currently active when the controller receives the command, the command will be rejected.

Message sent by: Integrator
Answer: **MID 0005 Command accepted** or
MID 0004 Command error, No alarm present or
Invalid data

For header description see section 2.2.2!

5.10.10 MID 1000 Alarm

An alarm has appeared in the controller. The current alarm is uploaded from the controller to the integrator. This MID replace the old alarm MID 0071.

Message sent by: Controller
Answer: **MID 1001 Alarm acknowledge**

Use MID 0008 to start subscription and MID 0009 to end subscription. Both without any extra data.

For header description see section 2.2.2!

Table 165 MID 1000 Alarm data

Parameter	Size [byte]	Data type	Value
Alarm code	5	S	The alarm code is specified by 5 ASCII characters, not used characters are replaced with space or according to application specific appendix.
Time	19	T	Time stamp for the alarm. 19 ASCII characters. YYYY-MM-DD:HH:MM:SS
Number of data fields	3	UI	The number of variable data fields in the telegram. If no data fields exist "000" will be sent. Must be the first of each section of variable data fields.
Data fields	Vary		This section is repeated Number of data fields times . If Number of data fields = 000, this section is not sent. The structure is of variable parameter type see the description in document "OpenProtocol_Specification_9836 4415 01" section 2.4 Variable data field use from OP spec 2.0

Below is a typical and recommended list of possible PIDs to be used together with MID 1000 Alarm. Each Open Protocol server/device can however specify other data to be sent, consult the device specific documentation.

Table 166 MID 1000 Alarm data typical PIDs revision 1

Parameter id (PID)	Name	Description
<i>Alarm information</i>		
01700	Alarm text	Alarm text, sent as String
01701	Alarm severity	Severity of the alarm, possible values are: 1 = Info 2 = Warning 3 = Error
<i>Torque controller information</i>		
01101	Torque controller Number	The number of the torque controller. For example be the drive index in a PF6000 system.
01104	Torque controller serial number	The serial number of the torque controller. Will be sent as a string
10100	Controller ready status	Sent as Boolean (Note: PID number is in PF4000 specific range)
<i>Tool information</i>		
01202	Tool serial number	The serial number of the tool. Will be sent as a string
01205	Tool number	The number of the tool
10101	Tool ready status	Sent as Boolean (Note: PID number is in PF4000 specific range)
10102	Tool health status	Sent as Boolean (Note: PID number is in PF4000 specific range)
<i>Carrier information</i>		
20010	Carrier number	The number of the carrier (Note: PID number is in PF6000 specific range)
20011	Serial number carrier	The serial number of the carrier (Note: PID number is in PF6000 specific range)

5.10.11 MID 1001 Alarm acknowledge

Acknowledge for MID 1000 Alarm

Message sent by: Integrator
Answer: **None**

5.11 Application Time messages

5.11.1 MID 0080 Read time upload request

Read time request.

Message sent by: Integrator
Answer: **MID 0081 Read time upload reply**

For header description see section 2.2.2!

5.11.2 MID 0081 Read time upload reply

Time upload reply from the controller.

Message sent by: Controller
Answer: None

For header description see section 2.2.2!

Table 167 MID 0081 Revision 1

Parameter	Byte	Value
Time	21-39	19 ASCII characters: YYYY-MM-DD:HH:MM:SS

5.11.3 MID 0082 Set Time

Set the time in the controller.

Message sent by: Integrator
Answer: **MID 0005 Command accepted**

For header description see section 2.2.2!

Table 168 MID 0082 Revision 1

Parameter	Byte	Value
Time	21-39	19 ASCII characters: YYYY-MM-DD:HH:MM:SS

5.12 Application Multi-spindle status messages

The multi-spindle messages for Power Focus are always exchanged with a sync Master. For PowerMACS, these messages are exchanged with the station using the IP address of the station TC.

5.12.1 MID 0090 Multi-spindle status subscribe

A subscription for the multi-spindle status. For Power Focus, the subscription must be addressed to the sync Master.

Message sent by: Integrator
 Answer: **MID 0005 Command accepted** or
MID 0004 Command error, Controller is not a sync master/station controller, or Multi-spindle status subscription already exists

For header description see section 2.2.2!

5.12.2 MID 0091 Multi-spindle status

The multi-spindle status is sent after each sync tightening. The multiple status contains the common status of the multiple as well as the individual status of each spindle.

Message sent by: Controller
 Answer: **MID 0092 Multi-spindle status acknowledge**

Example: Multiple status for two spindles. Common status OK, spindle 1 OK, spindle 2 OK.

00670091	01020200012032001-06-02:10:14:26 041050120102041NUL
----------	---

For header description see section 2.2.2!

Table 169 MID 0091 Multi-spindle status data

Parameter	Byte	Value
Number of spindles	21-22	01
	23-24	Number of spindles running in the multiple. The number of spindles is two bytes long and specified by 2 ASCII digits, range 02-10.
Sync tightening ID	25-26	02
	27-31	The sync tightening ID is a unique ID for each sync tightening result. Each individual result of each spindle is stamped with this ID. The tightening ID is incremented after each sync tightening. It is specified by five ASCII digits. Range: 00000-65535.
Time	32-33	03
	34-52	Time stamp. 19 ASCII characters. YYYY-MM-DD:HH:MM:SS
Sync overall status	53-54	04
	55	The status of all the spindles. OK if the individual status of each spindle is OK, NOK if at least one spindles status is NOK. One ASCII digit 1=OK, 0=NOK.
Spindle status	56-57	05

	58-5 × number of spindles.	Bytes 1-2: The first two bytes specify the spindle number in the same order as in the sync list. Range 01-99. Bytes 3-4: The next two bytes are the channel ID of the spindle. Range 01-99 Byte 5: The fifth byte is the individual overall status of the tightening of each spindle 0=NOK, 1=OK
--	-------------------------------------	--

5.12.3 MID 0092 Multi-spindle status acknowledge

Multi-spindle status acknowledge.

Message sent by: Integrator

Answer: None

For header description see section 2.2.2!

5.12.4 MID 0093 Multi-spindle status unsubscribe

Reset the subscription for the multi-spindle status.

Message sent by: Integrator

Answer: **MID 0005 Command accepted** or
MID 0004 Command error, Multi-spindle status subscription does not exist

For header description see section 2.2.2!

5.13 Application Multi-spindle result messages

The multi-spindle messages for Power Focus are always exchanged with a sync Master. For PowerMACS, these messages are exchanged with the station using the IP address of the station TC.

5.13.1 MID 0100 Multi-spindle result subscribe

A subscription for the multi-spindle status. For Power Focus, the subscription must be addressed to a sync Master.

This telegram is also used for a PowerMACS 4000 system running a press instead of a spindle. A press system only supports revision 4 and higher of the telegram and will answer with MID 0004, MID revision unsupported if a subscription is made with a lower revision.

Message sent by: Integrator

Answer: MID 0005 Command accepted or
MID 0004 Command error, Controller is not a sync master/station controller,
Multi-spindle result subscription already exists or MID revision unsupported

For header description see section 2.2.2!

(Revision 1 contains no data!)

Table 170 MID 0100 Revision 2

Parameter	Byte	Value
Data No. System	21-30	Data No System (see MID 0106) is the number for the cycle data to rewind to. The first cycle data will be the cycle data <u>after</u> this point. If the data is not found, or if the value is 0, rewind will be to oldest possible cycle data.

Table 171 MID 0100 Revision 3, 4, 5 and 6

Parameter	Byte	Value
Send only new data	31	Send only new result data. One ASCII digit 0=FALSE, 1=TRUE. If TRUE then only the result data stored after that the subscription is done is sent to the subscriber. Old result data of the unsent result will not be sent to the subscriber. This parameter has higher priorities than "Data No. System". So if this is TRUE, value in byte 21-30 is ignored and not performed.

5.13.2 MID 0101 Multi-spindle result

The multi-spindle result is sent after each sync tightening and if it is subscribed. The multiple results contain the common status of the multiple as well as the individual tightening result (torque and angle) of each spindle.

This telegram is also used for PowerMACS systems running a Press. The layout of the telegram is exactly the same but some of the fields have slightly different definitions. The fields for Torque are used for Force values and the fields for Angle are used for Stroke values. A press system always uses revision 4 or higher of the telegram.

Message sent by: Controller
 Answer: **MID 0102 Multi-spindle result acknowledge**
 if MID 0101 is sent due to a subscription or
None if MID 0101 is sent as a MID 0104 reply

For header description see section 2.2.2!

Table 172 MID 0101 Multi-spindle result data, Revision 1, 2 and 3

Parameter	Byte	Value
Number of spindles	21-22	01
	23-24	Number of spindles running in the multiple. The number of spindles is two bytes long and specified by 2 ASCII digits, range 01-50.
VIN Number	25-26	02
	27-51	The VIN number is 25 bytes long and is specified by 25 ASCII characters.
Job ID	52-53	03
	54-55	The Job ID is two bytes long and specified by two ASCII digits. Range: 00-99
Parameter set ID	56-57	04
	58-60	The parameter set ID is three bytes long and specified by three ASCII digits. Range: 000-999.
Batch size	61-62	05
	63-66	This parameter gives the total number of tightening in the batch. The batch size is four bytes long and specified by four ASCII digits. Range: 0000-9999.
Batch counter	67-68	06
	69-72	The batch counter information is four bytes long specifying and specified by four ASCII digits. Range: 0000-9999.
Batch status	73-74	07
	75	The batch status is specified by one ASCII character. 0=batch NOK (batch not completed), 1=batch OK, 2=batch not used.
Torque Min limit	76-77	08
	78-83	The torque min limit in Nm is multiplied by 100 and sent as an integer (2 decimals truncated). It is six bytes long and is specified by six ASCII digits.
Torque Max limit	84-85	09

Parameter	Byte	Value
	86-91	The torque max limit in Nm is multiplied by 100 and sent as an integer (2 decimals truncated). It is six bytes long and is specified by six ASCII digits.
Torque final target	92-93	10
	94-99	The torque final target in Nm is multiplied by 100 and sent as an integer (2 decimals truncated). It is six bytes long and is specified by six ASCII digits.
Angle Min	100-101	11
	102-106	The angle min value in degrees. Each turn represents 360 degrees. It is five bytes long and specified by five ASCII digits. Range: 00000-99999.
Angle Max	107-108	12
	109-113	The angle max value in degrees. Each turn represents 360 degrees. It is five bytes long and specified by five ASCII digits. Range: 00000-99999.
Final Angle Target	114-115	13
	116-120	The target angle value in degrees. Each turn represents 360 degrees. It is five bytes long and specified by five ASCII digits. Range: 00000-99999.
Date/time of last change in parameter set settings	121-122	14
	123-141	Time stamp for the last change in the current parameter set settings. It is 19 bytes long and is specified by 19 ASCII characters (YYYY-MM-DD:HH:MM:SS).
Time stamp	142-143	15
	144-162	Time stamp. 19 ASCII characters (YYYY-MM-DD:HH:MM:SS).
Sync tightening ID	163-164	16
	165-169	The sync tightening ID is a unique ID for each sync tightening result. Each individual result of each spindle is stamped with this ID. The tightening ID is incremented after each sync tightening. 5 ASCII digits, range 00000-65535.
Sync overall status	170-171	17
	172	The status of all the spindles. OK if the individual status of each spindle is OK, NOK if at least one spindle status is NOK. One ASCII digit 1=OK, 0=NOK.
Spindle status	173-174	18
	175 - 175 + 18 x number of spindles	18 × number of spindles.
		Bytes 1-2: Spindle number in the same order as in the sync list. Range 01-99.
		Bytes 3-4:
		Byte 5: Individual overall status of the tightening of each spindle 0=NOK, 1=OK
Byte 6: Individual torque status of each spindle. 0=Low, 1=OK, 2 = High		

All messages

Parameter	Byte	Value
		Byte 7-12: The torque result of each spindle. The torque in Nm is multiplied by 100 and sent as an integer (2 decimals truncated). It is six bytes long and specified by six ASCII digits.
		Byte 13: Individual angle status of each spindle. 0=NOK, 1=OK
		Byte 14-18: The turning angle value in degrees for each spindle. Each turn represents 360 degrees. It is five bytes long and specified by five ASCII digits. Range: 00000-99999.

Note: In a Power MACS system the unit used for torque measurement depends on the unit setting in the Power MACS setup. If the setup use Nm that unit is used in the telegram and if the setup use FtLbs the telegrams also use FtLbs.

Table 173 MID 0101 Multi-spindle result data, Revision 4

Parameter	Byte	Value
Number of spindles or presses	21-22	01
	23-24	Number of spindles or presses running in the multiple. The number is two bytes long and specified by 2 ASCII digits, range 01-50.
VIN Number	25-26	02
	27-51	The VIN number is 25 bytes long and is specified by 25 ASCII characters.
Job ID	52-53	03
	54-55	The Job ID is two bytes long and specified by two ASCII digits. Range: 00-99
Parameter set ID	56-57	04
	58-60	The parameter set ID is three bytes long and specified by three ASCII digits. Range: 000-999.
Batch size	61-62	05
	63-66	This parameter gives the total number of cycles in the batch. The batch size is four bytes long and specified by four ASCII digits. Range: 0000-9999.
Batch counter	67-68	06
	69-72	The batch counter information is four bytes long specifying and specified by four ASCII digits. Range: 0000-9999.
Batch status	73-74	07
	75	The batch status is specified by one ASCII character. 0=batch NOK (batch not completed), 1=batch OK, 2=batch not used.
Torque or Force Min limit	76-77	08
	78-83	The torque or force min limit, see description of torque and force values below.
Torque or Force Max limit	84-85	09
	86-91	The torque or force max limit, see description of torque and force values below.
Torque of Force final target	92-93	10
	94-99	The torque or force final target, see description of torque and force values below.
Angle or Stroke Min limit	100-101	11
	102-106	Angle or stroke min limit, see description of angle and stroke values below.
Angle or Stroke Max limit	107-108	12
	109-113	The angle or stroke max limit, see description of angle and stroke values below.
Final Angle or Stroke Target	114-115	13
	116-120	The target angle or stroke value, see description of angle and stroke values below..
Date/time of last change in parameter set settings	121-122	14
	123-141	Time stamp for the last change in the current parameter set settings. It is 19 bytes long and is specified by 19 ASCII characters (YYYY-MM-DD:HH:MM:SS).

All messages

Parameter	Byte	Value
Time stamp	142-143	15
	144-162	Time stamp. 19 ASCII characters (YYYY-MM-DD:HH:MM:SS).
Sync tightening ID	163-164	16
	165-169	The identity is a unique ID for each sync result. Each individual result of each spindle or press is stamped with this ID. The ID is incremented after each sync cycle. 5 ASCII digits, range 00000-65535.
Sync overall status	170-171	17
	172	The status of all the spindles or presses. OK if the individual status of each spindle or press is OK, NOK if at least one of them has status NOK. One ASCII digit 1=OK, 0=NOK.
Spindle or Press status	173-174	18
	175 - 175 + 18 x number of spindles	18 × number of spindles or presses
		Bytes 1-2: Spindle or press number in the same order as in the sync list. Range 01-99.
		Bytes 3-4: Channel ID of the spindle or press. Range 01-99
		Byte 5: Individual overall status of the cycle of each spindle or press. 0=NOK, 1=OK
		Byte 6: Individual torque or force status of each spindle or press. 0=NOK, 1=OK
		Byte 7-12: The torque or force result of each spindle or press, see description of torque and force values below.
		Byte 13: Individual angle or stroke status of each spindle or press. 0=NOK, 1=OK
Byte 14-18: The measured angle or stroke value for each spindle or press, see description of angle and stroke values below.		
System sub type	+2	19
	+3	The subtype of the system sending the data. 3 ASCII digits. Have the same value as the field System subtype in MID 0002 Communication start acknowledge. For a PowerMACS 4000 system it can have the following values: 001 = a normal tightening system 002 = a system running presses instead of spindles. If the system subtype is 002 for Press all the data above is Force and Stroke instead of Torque and Angle

Table 174 MID 0101 Multi-spindle result data, Revision 5

Job sequence number	+2	20
	+5	The Job sequence number is unique for each Job. All tightenings performed in the same Job are stamped with the same Job sequence number. It is specified by five ASCII digits. Range: 00000-65535. When unused should be: 00000

Table 175 MID 0101 Multi-spindle result data, Revision 6

Parameter	Byte	Value
Number of spindles or presses	21-22	01
	23-24	Number of spindles or presses running in the multiple. The number is two bytes long and specified by 2 ASCII digits, range 01-50.
VIN Number	25-26	02
	27-51	The VIN number is 25 bytes long and is specified by 25 ASCII characters.
Job ID	52-53	03
	54-55	The Job ID is two bytes long and specified by two ASCII digits. Range: 00-99
Parameter set ID	56-57	04
	58-60	The parameter set ID is three bytes long and specified by three ASCII digits. Range: 000-999.
Batch size	61-62	05
	63-66	This parameter gives the total number of cycles in the batch. The batch size is four bytes long and specified by four ASCII digits. Range: 0000-9999.
Batch counter	67-68	06
	69-72	The batch counter information is four bytes long specifying and specified by four ASCII digits. Range: 0000-9999.
Batch status	73-74	07
	75	The batch status is specified by one ASCII character. 0=batch NOK, 1=batch OK, 2=batch not used, 3=batch running
Torque or Force Min limit	76-77	08
	78-83	The torque or force min limit, see description of torque and force values below.
Torque or Force Max limit	84-85	09
	86-91	The torque or force max limit, see description of torque and force values below.
Torque of Force final target	92-93	10
	94-99	The torque or force final target, see description of torque and force values below.
Angle or Stroke Min limit	100-101	11
	102-106	Angle or stroke min limit, see description of angle and stroke values below.
Angle or Stroke Max limit	107-108	12
	109-113	The angle or stroke max limit, see description of angle and stroke values below.

All messages

Parameter	Byte	Value
Final Angle or Stroke Target	114-115	13
	116-120	The target angle or stroke value, see description of angle and stroke values below..
Date/time of last change in parameter set settings	121-122	14
	123-141	Time stamp for the last change in the current parameter set settings. It is 19 bytes long and is specified by 19 ASCII characters (YYYY-MM-DD:HH:MM:SS).
Time stamp	142-143	15
	144-162	Time stamp. 19 ASCII characters (YYYY-MM-DD:HH:MM:SS).
Sync tightening ID	163-164	16
	165-169	The identity is a unique ID for each sync result. Each individual result of each spindle or press is stamped with this ID. The ID is incremented after each sync cycle. 5 ASCII digits, range 00000-65535.
Sync overall status	170-171	17
	172	The status of all the spindles or presses. OK if the individual status of each spindle or press is OK, NOK if at least one of them has status NOK. One ASCII digit 1=OK, 0=NOK.
Spindle or Press status	173-174	18
	175 - 175 + 18 x number of spindles	18 × number of spindles or presses
		Bytes 1-2: Spindle or press number in the same order as in the sync list. Range 01-99.
		Bytes 3-4: Channel ID of the spindle or press. Range 01-99
		Byte 5: Individual overall status of the cycle of each spindle or press. 0=NOK, 1=OK
		Byte 6: Individual torque or force status of each spindle or press. 0=NOK, 1=OK
		Byte 7-12: The torque or force result of each spindle or press, see description of torque and force values below.
		Byte 13: Individual angle or stroke status of each spindle or press. 0=NOK, 1=OK
Byte 14-18: The measured angle or stroke value for each spindle or press, see description of angle and stroke values below.		

Parameter	Byte	Value
System sub type	+2	19
	+3	The subtype of the system sending the data. 3 ASCII digits. Have the same value as the field System subtype in MID 0002 Communication start acknowledge. For a PowerMACS 4000 system it can have the following values: 001 = a normal tightening system 002 = a system running presses instead of spindles. If the system subtype is 002 for Press all the data above is Force and Stroke instead of Torque and Angle
Job sequence number	+2	20
	+5	The Job sequence number is unique for each Job. All tightenings performed in the same Job are stamped with the same Job sequence number. It is specified by five ASCII digits. Range: 00000-65535. When unused should be: 00000

Angle values:

Sent with unit degrees. Each turn represents 360 degrees. It is five bytes long and specified by five ASCII digits. Range: -9999 – 99999.

Stroke values:

Sent with unit mm. The value is multiplied by 100 and sent as an integer (2 decimals truncated). It is five bytes long and is specified by five ASCII digits. Range -99.99 – +999.99 mm sent as -9999 – 99999.

Torque values:

The torque is multiplied by 100 and sent as an integer (2 decimals truncated). It is six bytes long and is specified by six ASCII digits. The unit is Nm. Range: -999.99 – 9999.99 Nm sent as -99999 – 999999.

Force values:

The force is multiplied by 100 and sent as an integer (2 decimals truncated). It is six bytes long and is specified by six ASCII digits. The unit is kN. Range: -999.99 – 9999.99 kN sent as -99999 – 999999.

Note: In revision 4 of the telegram a PowerMACS system always use Nm for the torque measurement, independent of the setting in the PowerMACS setup. The unit of force measurements in a press system is always kN.

5.13.3 MID 0102 Multi-spindle result acknowledge

Multi-spindle result acknowledge.

Message sent by: Integrator
Answer: None

For header description see section 2.2.2!

5.13.4 MID 0103 Multi spindle result unsubscribe

Reset the subscription for the multi spindle result.

Message sent by: Integrator
Answer: **MID 0005 Command accepted** or
MID 0004 Command error, Multi spindle result subscription does not exist

For header description see section 2.2.2!

5.13.5 MID 0104 Old Multi spindle result request

Request for an old multi spindle result.

Note: MID 0104 can't be used if there is an active subscription for multiple spindle results.

Message sent by: Integrator
Answer: **MID 0101 Multi-spindle result** or
MID 0004 Command error, Multi spindle result subscription already exist

For header description see section 2.2.2!

Table 176 MID 0104 Revision 1 to 6

Parameter	Byte	Value
Requested Result Index	21-22	01
	23-33	Index of tightening result. Index as returned by MID.0067 . 10 digits.

Note: Timestamp may be used to verify that the reply matches the request.

5.14 Application PowerMACS result data

The PowerMACS result data MIDs allow for step data to be sent, as well as most other available PowerMACS result variables. The intention is also that it should be easy to add any new result variables without having to change the protocol specification.

The variables that are sent with Open Protocol are selected in the reporter in PowerMACS. The data needed for the station messages and for the header part of the Bolt messages are always selected. For most of the remaining data is possible to select if it should be sent or not. All data is listed in the Appendix PowerMACS data, names for variable identification

The fields Width and Decimals in the reporter are not accessible; the data is always formatted according to the message specifications.

5.14.1 MID 0105 Last PowerMACS tightening result data subscribe

Set the subscription for the rundowns result. The result of this command will be the transmission of the rundown result after the tightening is performed (push function).

This telegram is also used for a PowerMACS 4000 system running a press instead of a spindle. A press system only supports revision 4 and higher of the telegram and will answer with MID 0004, MID revision unsupported if a subscription is made with a lower revision.

Message sent by: Integrator

Answer: MID 0005 Command accepted or
MID 0004 Command error, Subscription already exists or MID revision
unsupported

For header description see section 2.2.2!

(OBS! Revision 1 contains no data!)

Table 177 MID 0105 Revision 2, 3 and 4

Parameter	Revision	Byte	Value
Data No System	2-3	21-30	Data No System (see MID 0106) is the system number of the cycle data to rewind to. Two ASCII digits 00. The first cycle data will be the cycle data <u>after</u> this point. If the data is not found, or if the value is 0, rewind will be to oldest possible cycle data.
Send only new data	3	31	Send only new result data. One ASCII digit 0=FALSE, 1=TRUE. If TRUE then only the result data stored after that the subscription is done is sent to the subscriber. Old result data of the unsent result will not be sent to the subscriber. This parameter has higher priorities than "Data No System". So if this is TRUE, value in byte 21-30 is ignored and not preformed.

5.14.2 MID 0106 Last PowerMACS tightening result Station data

This MID contains the station part and some of the Bolt data of the last result data. After this message has been sent the integrator selects if it also wants to have the Bolt and step data. If this data is requested, then the integrator sends the message **MID 0108 Last PowerMACS tightening result data acknowledge**, with the parameter Bolt Data set to **TRUE**. If only the station data is wanted the parameter Bolt Data is set to **FALSE**.

This telegram is also used for Power MACS systems running a Press. The layout of the telegram is exactly the same but some of the fields have slightly different definitions. The fields for Torque are used for Force values and the fields for Angle are used for Stroke values. Press systems also use different identifiers for the optional data on bolt and step level. A press system always use revision 4 or higher of the telegram

Note: All values that are undefined in the results will be sent as all spaces (ASCII 0x20). This will for instance happen with the Torque Status if no measuring value for Bolt T was available for the tightening.

Message sent by: Controller

Answer: **MID 0108 Last Power MACS tightening result data acknowledge**

For header description see section 2.2.2!

Table 178 MID 0106 Last tightening result Station data, revision 1,2 and 3

Parameter	Byte	Value
Total no of messages	21-22	01
	23-24	The total number of messages needed to send all Bolt data for all Bolts. The rest of the messages are of type MID 0107 Last PowerMACS tightening result Bolt data , once for each Bolt. They are only sent on request from the integrator. 2 ASCII digits, range 00-99.
Message number	25-26	02
	27-28	This parameter is always 01 as this is the first message.

Parameter	Byte	Value
Data No System	29-30	03
	31-40	The Data No system is a unique ID for each tightening result within the system. 10 ASCII digits, max value are 4294967295.
Station No	41-42	04
	43-44	The station number within the PowerMACS system. 2 ASCII digits, range 01-15.
Station Name	45-46	05
	47-66	The station name is 20 bytes long and is specified by 20 ASCII characters.
Time	67-68	06
	69-87	Cycle start time for each tightening sent to the control station. The time is 19 byte long and is specified by 19 ASCII characters (YYYY-MM-DD:HH:MM:SS)
Mode No	88-89	07
	90-91	The mode number used for the tightening. 2 ASCII digits, range 01-50. If undefined, empty spaces are sent.
Mode Name	92-93	08
	94-113	The name of the mode used for the tightening. Specified by 20 ASCII characters. If undefined, empty spaces are sent.
Simple status	114-115	09
	116	One byte long and is specified by one ASCII digit ('0' or '1'). 0=tightening NOK, 1=tightening OK.
PM Status	117-118	10
	119	The status of the tightening, specified by one ASCII digit. 0=OK, 1=OKR, 2=NOK, 3=TERMNOK.
Wp. Id	120-121	11
	122-161	The Wp. Id is 40 bytes long and is specified by 40 ASCII characters. If undefined, empty spaces are sent.
Number of Bolts	162-163	12
	164-165	The total number of Bolts in the tightening, 2 ASCII digits. The Bolt part in this message (indicated with double table border) is repeated Number of Bolt times. The parameter numbers (13-22) are also repeated.

All messages

Parameter	Byte	Value
Ordinal Bolt Number	+2	13
	+2	The ordinal Bolt number, the Bolts in the station are always numbered from 01 to 50. 2 ASCII digits.
Simple Bolt Status	+2	14
	+1	Specified by one ASCII digit ('0' or '1'). 0=tightening NOK, 1=tightening OK.
Torque Status	+2	15
	+1	Torque status of each Bolt, specified by one ASCII digit 0=Bolt T Low 1=Bolt T OK 2=Bolt T High If undefined, empty spaces are sent.
Angle Status	+2	16
	+1	Angle status of each Bolt, specified by one ASCII digit 0=Bolt A Low 1=Bolt A OK 2=Bolt A High If undefined, empty spaces are sent.
Bolt T	+2	17
	+7	Sent as 7 ASCII digits formatted as a float. The value is sent with 4 decimal places, for example 99.9999 or -9.9999. If the value is larger than 99 the needed number of decimals are removed to fit the integer part, i.e. 12345.123 is sent as "12345.1". The unit is Nm. If undefined, empty spaces are sent.
Bolt A	+2	18
	+7	Sent as 7 ASCII digits, formatted as a float, see description for Bolt T. The unit is degrees. If undefined, empty spaces are sent.
Bolt T High Limit	+2	19
	+7	Sent as 7 ASCII digits, formatted as a float, see description for Bolt T. The unit is Nm. If undefined, empty spaces are sent.
Bolt T Low Limit	+2	20
	+7	Sent as 7 ASCII digits, formatted as a float, see description for Bolt T. The unit is Nm. If undefined, empty spaces are sent.
Bolt A High Limit	+2	21
	+7	Sent as 7 ASCII digits, formatted as a float, see description for Bolt T. The unit is degrees. If undefined, empty spaces are sent.
Bolt A Low Limit	+2	22
	+7	Sent as 7 ASCII digits, formatted as a float, see description for Bolt T. The unit is degrees. If undefined, empty spaces are sent.

Parameter	Byte	Value	
Number of special values	+2	23	
	+2	The total number of special values sent in this message. Range 00-99.	
	+ n x number of special values	This section is repeated Number of special values times. If Number of special values=00, this section is not sent.	
		Byte 1-20:	Variable name. 20 ASCII characters
		Byte 21-22:	Type: 2 ASCII characters.
		Byte 23-34:	Length: 2 ASCII digits.
Byte 25- :	Value: The value of the variable. The format and length depend on the parameters Type and Length.		

Note 1: All fields with strings are left adjusted and padded with spaces. All numerical fields are right adjusted and padded with 0's.

Note 2: In revision 1, 2 and 3 of the telegram the unit used for torque measurement depends on the unit setting in the PowerMACS setup. If the setup use Nm that unit is used in the telegram and if the setup use FtLbs the telegrams also use FtLbs.

Note 3: Special values is defined in device specific specification/appendix. For Power MACS this can be found in section 2.2.3 in Open Protocol Power MACS Specification.

Table 179 MID 0106 Last tightening result Station data, revision 4

Parameter	Byte	Value
Total no of messages	21-22	01
	23-24	The total number of messages needed to send all Bolt (object) data for all Bolts. The rest of the messages are of type MID 0107 Last PowerMACS tightening result Bolt data , once for each Bolt. They are only sent on request from the integrator. 2 ASCII digits, range 00-99.
Message number	25-26	02
	27-28	This parameter is always 01 as this is the first message.
Data No System	29-30	03
	31-40	The Data No system is a unique ID for each result within the system. 10 ASCII digits, max value are 4294967295.
Station No	41-42	04
	43-44	The station number within the PowerMACS system. 2 ASCII digits, range 01-15.
Station Name	45-46	05
	47-66	The station name is 20 bytes long and is specified by 20 ASCII characters.
Time	67-68	06
	69-87	Cycle start time for each cycle sent to the control station. The time is 19 byte long and is specified by 19 ASCII characters (YYYY-MM-DD:HH:MM:SS)
Mode No	88-89	07

All messages

Parameter	Byte	Value
	90-91	The mode number used for the cycle. 2 ASCII digits, range 01-50. If undefined, empty spaces are sent.
Mode Name	92-93	08
	94-113	The name of the mode used for the cycle. Specified by 20 ASCII characters. If undefined, empty spaces are sent.
Simple status	114-115	09
	116	One byte long and is specified by one ASCII digit ('0' or '1'). 0=cycle NOK, 1=cycle OK.
PM Status	117-118	10
	119	The status of the tightening (pressing), specified by one ASCII digit. 0=OK, 1=OKR, 2=NOK, 3=TERMNOK.
Wp. Id	120-121	11
	122-161	The Wp. Id is 40 bytes long and is specified by 40 ASCII characters. If undefined, empty spaces are sent.
Number of Bolts or Objects	162-163	12
	164-165	The total number of Bolts or Objects in the tightening, 2 ASCII digits. The Bolt/Object part in this message (indicated with double table border) is repeated Number of Bolt times. The parameter numbers (13-22) are also repeated.

Parameter	Byte	Value
Ordinal Bolt or Object Number	+2	13
	+2	The ordinal Bolt (object) number, the Bolts in the station are always numbered from 01 to 50. 2 ASCII digits.
Simple Bolt or Object Status	+2	14
	+1	Specified by one ASCII digit ('0' or '1'). 0=cycle NOK, 1=cycle OK.
Torque or Force Status	+2	15
	+1	Torque or force status of each Bolt or Object, specified by one ASCII digit 0=Bolt T Low (Object F Low) 1=Bolt T OK (Object F OK) 2=Bolt T High (Object F High) If undefined, empty spaces are sent.
Angle or Stroke Status	+2	16
	+1	Angle or stroke status of each Bolt or Object, specified by one ASCII digit 0=Bolt A Low (Object S Low) 1=Bolt A OK (Object S OK) 2=Bolt A High (Object S High) If undefined, empty spaces are sent.
Bolt T or Object F	+2	17
	+7	Sent as 7 ASCII digits formatted as a float. The value is sent with 4 decimal places, for example 99.9999 or -9.9999. If the value is larger than 99 the needed number of decimals are removed to fit the integer part, i.e. 12345.123 is sent as "12345.1". The unit is Nm in a tightening system and kN in a press system. If undefined, empty spaces are sent.
Bolt A or Object S	+2	18
	+7	Sent as 7 ASCII digits, formatted as a float, see description for Bolt T. The unit is degrees in a tightening system and mm in a press system. If undefined, empty spaces are sent.
Bolt T or Object F High Limit	+2	19
	+7	Sent as 7 ASCII digits, formatted as a float, see description for Bolt T. The unit is Nm in a tightening system and kN in a press system. If undefined, empty spaces are sent.
Bolt T or Object F Low Limit	+2	20
	+7	Sent as 7 ASCII digits, formatted as a float, see description for Bolt T. The unit is Nm in a tightening system and kN in a press system. If undefined, empty spaces are sent.
Bolt A or Object S High Limit	+2	21
	+7	Sent as 7 ASCII digits, formatted as a float, see description for Bolt T. The unit is degrees in a tightening system and mm in a press system. If undefined, empty spaces are sent.
Bolt A or Object S Low Limit	+2	22
	+7	Sent as 7 ASCII digits, formatted as a float, see description for Bolt T. The unit is degrees in a tightening system and mm in a press system. If undefined, empty spaces are sent.

Parameter	Byte	Value	
Number of special values	+2	23	
	+2	The total number of special values sent in this message. Range 00-99.	
	+ n x number of special values	This section is repeated Number of special values times. If Number of special values=00, this section is not sent.	
		Byte 1-20:	Variable name. 20 ASCII characters.
		Byte 21-22:	Type: 2 ASCII characters.
		Byte 23-34:	Length: 2 ASCII digits.
Byte 25- :	Value: The value of the variable. The format and length depend on the parameters Type and Length.		
System sub type	+2	24	
	+3	<p>The subtype of the system sending the data. 3 ASCII characters. Have the same value as the filed System subtype in MID 0002 Communication start acknowledge.</p> <p>For a PowerMACS 4000 system it can have the following values: 001 = a normal tightening system 002 = a system running presses instead of spindles. Subtype is 002 for Press all the data above is Force and Stroke instead of Torque and Angle .</p> <p>This part follows directly after the last special value. The byte numbers vary depending on the number of data sent earlier in the telegram.</p>	

Note 1: All fields with strings are left adjusted and padded with spaces. All numerical fields are right adjusted and padded with 0's.

Note 2: In revision 4 of the telegram the unit used for torque measurement are always Nm, independent of the unit selection in the Power MACS setup. The unit used for force measurements in a press system is always kN.

5.14.3 MID 0107 Last Power MACS tightening result Bolt data

This message contains the cycle data for one Bolt, both Bolt data and step data. It is only sent if the acknowledgement of the message **MID 0106 Last PowerMACS tightening result station data** had the parameter Bolt Data set to **TRUE**. The next Bolt data is sent if the acknowledgement has the parameter Bolt Data set to **TRUE**.

This telegram is also used for Power MACS systems running a Press. The layout of the telegram is exactly the same but some of the fields have slightly different definitions. The fields for Torque are used for Force values and the fields for Angle are used for Stroke values. Press systems also use different identifiers for the optional data on bolt and step level. Press systems always use revision 4 or higher of the telegram. Values in the fixed part that are undefined in the results will be sent as all spaces (ASCII 0x20). This can happen with the Customer Error Code if this function is not activated.

Note 2: The Bolt results and step results are only sent when the value exists in the result. This means, for example, that if no high limit is programmed for Peak T, then the value Peak T + will not be sent even if limits for Peak T are defined in the reporter.

Message sent by: Controller
 Answer: **MID 0108 Last PowerMACS tightening result data acknowledge**

For header description see section 2.2.2!

Table 180 MID 0107 Last tightening result Bolt data, revision 1, 2 and 3

Parameter	Byte	Value
Total no of messages	21-22	01
	23-24	The total number of messages needed to send all Bolt data for all Bolts, including the message MID 0106 Last Power MACS tightening result Station data, sent with the station data. One message MID 0107 Last Power MACS tightening result Bolt data is sent for each Bolt.
Message number	25-26	02
	27-28	This number counts from 02 to Total no of messages and is incremented by 1 for each sent message. The first Bolt message is message number 02, since MID 0106 Last Power MACS tightening result Station data is number 01. 2 ASCII digits, range 02-99.
Data No System	29-30	03
	31-40	The Data No system is a unique ID for each tightening result within the system. 10 ASCII digits, max value are 4294967295.
Station No	41-42	04
	43-44	The station number within the Power MACS system. 2 ASCII digits. Range 01-15.
Time	45-46	05
	47-55	Cycle start time for each tightening sent to the control station. The time is 19 byte long and is specified by 19 ASCII characters (YYYY-MM-DD:HH:MM:SS)
Bolt number	56-57	06
	58-61	The user defined Bolt number. 4 ASCII digits, range 0001-9999.
Bolt name	62-63	07
	64-83	The name of the Bolt. 20 ASCII characters.
Program name	84-85	08
	86-105	The name of the program that made the tightening, 20 ASCII characters.
PM status	106-107	09
	108	The status of the tightening specified by one ASCII digit. 0=OK, 1=OKR, 2=NOK, 3=TERMNOK.
Errors	109-110	10
	111-160	Error codes from the tightening. Formatted in the same way as the E1 special variable
Customer error code	161-162	11
	163-166	Customer specific error code. 4 ASCII characters. If undefined, empty spaces are sent.

All messages

Parameter	Byte	Value
Number of Bolt results	167-168	12
	169-170	The total number of Bolt results in the tightening, 2 ASCII digits. The Bolt result part in this message is repeated "Number of Bolt results" times.
	171-	This section is repeated Number of Bolt results times. If Number of Bolt results=00, this section is not sent.
		Byte 1-20:
Byte 21-22:		Type of the variable. 2 ASCII characters, I[space] for integers or F[space] for float.
	Byte 23-29:	Value. The value is sent as a 7 ASCII digits, and the format depends on the type. Type = I, the value is formatted like 9999999 or -999999 Type = F, the value is sent with 4 decimal places, i.e. it is formatted like 99.9999 or -9.9999. If the value is larger than 99 the needed number of decimals are removed to fit the integer part, i.e. 12345.123 is sent as "12345.1". The units for torque measurements are Nm and for angle measurements degrees.
Number of step results	+2	13
	+3	The total number of step results in the tightening, 3 ASCII digits. The step result part in this message is repeated "Number of step results" times.

Parameter	Byte	Value	
All step data sent	+2	14	
	+1	Set to TRUE if all the step data was possible to send, otherwise it is set to FALSE. All step data is not sent if the total amount of data is not possible to fit within the message size of 9999 bytes. This can happen if the program is very long and each step reports a lot of data. For a normal program this will never be a problem. If the step data was not possible to report none of the special values will be reported. One ASCII digit 0=FALSE, 1=TRUE.	
	+31	This section is repeated Number of step results times. If Number of step results=000, this section is not sent.	
		Byte 1-20:	Specifies the name of the variable. 20 ASCII characters
		Byte 21-22:	Specifies the type of the variable. 2 ASCII characters, I[space] for integers or F[space] for float.
Byte 23-29:		The value is sent as a 7 ASCII digits, and the format depends on the type. Type = I, the value is formatted like 9999999 or -9999999 Type = F, the value is sent with 4 decimal places, i.e. it is formatted like 99.9999 or -9.9999. If the value is larger than 99 the needed number of decimals are removed to fit the integer part, i.e. 12345.123 is sent as "12345.1". The units for torque measurements are Nm and for angle measurements degrees.	
Byte 30-31:	The step number for the result variable. 2 ASCII digits.		
Number of special values	+2	15	
	+2	The total number of special values sent in this message. Range 00-99.	
	+ n	This section is repeated Number of special values times. If Number of special values=00, this section is not sent.	
		Byte 1-20	Variable name. 20 ASCII characters
		Byte 21-22	Type: 2 ASCII characters.
		Byte 23-24	Length: 2 ASCII digits.
Byte 25-		Value: The value of the variable. The format and length depend on the parameters Type and Length.	
Byte n	The step number for the result variable, sent as 2 ASCII digits. For values that belong to the Bolt level, Step number is always 00.		

Note 1: All fields with strings are left adjusted and padded with spaces. All numerical fields are right adjusted and padded with 0's.

Note 2: In revision 1, 2 and 3 of the telegram the unit used for torque measurement depends on the unit setting in the PowerMACS setup. If the setup use Nm that unit is used in the telegram and if the setup use FtLbs the telegrams also use FtLbs.

Table 181 MID 0107 Last tightening result Bolt data, revision 4

Parameter	Byte	Value
Total no of messages	21-22	01
	23-24	The total number of messages needed to send all Bolt or Object data for all Bolts or Objects, including the message MID 0106 Last PowerMACS tightening result Station data, sent with the station data. One message MID 0107 Last PowerMACS tightening result Bolt data is sent for each Bolt or Object.
Message number	25-26	02
	27-28	This number counts from 02 to Total no of messages and is incremented by 1 for each sent message. The first Bolt message is message number 02, since MID 0106 Last PowerMACS tightening result Station data is number 01. 2 ASCII digits, range 02-99.
Data No System	29-30	03
	31-40	The Data No system is a unique ID for each cycle result within the system. 10 ASCII digits, max value are 4294967295.
Station No	41-42	04
	43-44	The station number within the PowerMACS system. 2 ASCII digits. Range 01-15.
Time	45-46	05
	47-55	Cycle start time for each cycle sent to the control station. The time is 19 byte long and is specified by 19 ASCII characters (YYYY-MM-DD:HH:MM:SS)
Bolt or Object number	56-57	06
	58-61	The user defined Bolt or Object number. 4 ASCII digits, range 0001-9999.
Bolt or Object name	62-63	07
	64-83	The name of the Bolt or Object. 20 ASCII characters.
Program name	84-85	08
	86-105	The name of the program that made the tightening or pressing, 20 ASCII characters.
PM status	106-107	09
	108	The status of the cycle specified by one ASCII digit. 0=OK, 1=OKR, 2=NOK, 3=TERMNOK.
Errors	109-110	10
	111-160	Error codes from the tightening or pressing. Formatted in the same way as the E1 special variable
Customer error code	161-162	11
	163-166	Customer specific error code. 4 ASCII characters. If undefined, empty spaces are sent.

Parameter	Byte	Value	
Number of Bolt or Object results	167-168	12	
	169-170	The total number of Bolt or Objects results in the telegram, 2 ASCII digits. The Bolt result part in this message is repeated "Number of Bolt results" times.	
	171-	This section is repeated Number of Bolt results times. If Number of Bolt results=00, this section is not sent.	
		Byte 1-20:	Variable name: 20 ASCII characters.
		Byte 21-22:	Type of the variable. 2 ASCII characters, I[space] for integers or F[space] for float.
Byte 23-29:	Value. The value is sent as a 7 ASCII digits, and the format depends on the type. Type = I, the value is formatted like 9999999 or -999999 Type = F, the value is sent with 4 decimal places, i.e. it is formatted like 99.9999 or -9.9999. If the value is larger than 99 the needed number of decimals are removed to fit the integer part, i.e. 12345.123 is sent as "12345.1". The units for torque measurements are Nm and for angle measurements degrees. In a press system the units are kN for force measurements and mm for stroke measurements.		
Number of step results	+2	13	
	+3	The total number of step results in the telegram, 3 ASCII digits. The step result part in this message is repeated "Number of step results" times.	

All messages

Parameter	Byte	Value
All step data sent	+2	14
	+1	Set to TRUE if all the step data was possible to send, otherwise it is set to FALSE. All step data is not sent if the total amount of data is not possible to fit within the message size of 9999 bytes. This can happen if the program is very long and each step reports a lot of data. For a normal program this will never be a problem. If the step data was not possible to report none of the special values will be reported. One ASCII digit 0=FALSE, 1=TRUE.
	+31	This section is repeated Number of step results times. If Number of step results=000, this section is not sent.
	Byte 1-20:	Specifies the name of the variable. 20 ASCII characters
	Byte 21-22:	Specifies the type of the variable. 2 ASCII characters, I[space] for integers or F[space] for float.
	Byte 23-29:	The value is sent as a 7 ASCII digits, and the format depends on the type. Type = I, the value is formatted like 9999999 or -9999999 Type = F, the value is sent with 4 decimal places, i.e. it is formatted like 99.9999 or -9.9999. If the value is larger than 99 the needed number of decimals are removed to fit the integer part, i.e. 12345.123 is sent as "12345.1". The units for torque measurements are Nm and for angle measurements degrees. In a press system the units are kN for force measurements and mm for stroke measurements.
	Byte 30-31:	The step number for the result variable. 2 ASCII digits.
Number of special values	+2	15
	+2	The total number of special values sent in this message. Range 00-99.

Parameter	Byte	Value
	+ n	This section is repeated Number of special values times. If Number of special values=00, this section is not sent.
		Byte 1-20 Variable name. 20 ASCII characters
		Byte 21-22 Type: 2 ASCII characters.
		Byte 23-24 Length: 2 ASCII digits.
		Byte 25- Value: The value of the variable. The format and length depend on the parameters Type and Length.
		Byte n The step number for the result variable, sent as 2 ASCII digits. For values that belong to the Bolt level, Step number is always 00.
System sub type	+2	16
	+3	<p>The subtype of the system sending the data. 3 ASCII characters. Have the same value as the filed System subtype in MID 0002 Communication start acknowledge.</p> <p>For a PowerMACS 4000 system it can have the following values: 001 = a normal tightening system 002 = a system running presses instead of spindles</p> <p>If the system subtype is 002 for Press all the data above is Force and Stroke instead of Torque and Angle</p>

Note 1: All fields with strings are left adjusted and padded with spaces. All numerical fields are right adjusted and padded with 0's.

Note 2: In revision 4 of the telegram the unit used for torque measurement are always Nm, independent of the unit selection in the PowerMACS setup. The unit used for force measurements in a press system is always kN.

5.14.4 MID 0108 Last Power MACS tightening result data acknowledge

If Bolt Data is set to **TRUE** the next telegram with Bolt data is sent (if there are any left for this tightening). Otherwise no more Bolt data is sent for this tightening.

If only the station data is wanted Bolt Data must be set to **FALSE** in the acknowledgement of **MID 0106 Last Power MACS tightening result Station data**.

Message sent by: Integrator
Answer: None

For header description see section 2.2.2!

Table 182 MID 0108 Revision 1-4

Parameter	Byte	Value
Bolt data	21	Specifies if Bolt data is requested or not. One ASCII character: 0=false, 1=true.

5.14.5 MID 0109 Last Power MACS tightening result data unsubscribe

Reset the last Power MACS tightening result subscription for the rundowns result.

Message sent by: Integrator
Answer: **MID 0005 Command accepted** or
MID 0004 Command error, Subscription does not exist

For header description see section 2.2.2!

5.15 Application User interface messages

5.15.1 MID 0110 Display user text on compact

By sending this message the integrator can display a text on the compact display. The text must be maximum 4 bytes long.

The characters that can be displayed are limited due to the hardware of the compact display.

Each character must fit into seven segments. This means for example that it is not possible to display an M on the compact display.

The text will be displayed until next tightening, new parameter set or Job selection, or alarm code.

Message sent by: Integrator
 Answer: **MID 0005 Command accepted** or
MID 0004 Command error, User text could not be displayed

For header description see section 2.2.2!

Table 183 MID 0110 Revision 1

Parameter	Byte	Value
User text	21-24	Max four characters, right padded with SPC 0x20

5.15.2 MID 0111 Display user text on graph

By sending this message the integrator can display a text on the graphic display. The user can furthermore set the time for the text to be displayed and if the text should be acknowledged by the operator or not.

The text is divided into four lines with 25 ASCII characters each. If a line is shorter than 25 characters it must be right padded with blanks (SPC 0x20).

The first line is the text header and is in upper character.

Message sent by: Integrator
 Answer: **MID 0005 Command accepted** or
MID 0004 Command error, User text could not be displayed

For header description see section 2.2.2!

Table 184 MID 0110 Graphic text display

Parameter	Byte	Value
Text Duration	21-22	01
	23-26	Time for the text to be displayed, in seconds. Four ASCII digits, range: 0000-9999
Removal condition	27-28	02
	29	0= acknowledge or wait expiration time 1= acknowledge
Line 1 (text header)	30-31	03
	32-56	25 ASCII characters
Line 2	57-58	04
	59-83	25 ASCII characters
Line 3	84-85	05
	86-110	25 ASCII characters
Line 4	111-112	06
	113-137	25 ASCII characters

5.15.3 MID 0113 Flash green light on tool

By sending this message the integrator can make the green light on the tool flash. The light on the tool will flash until the operator pushes the tool trigger.

Message sent by: Integrator
Answer: **MID 0005 Command accepted**

For header description see section 2.2.2!

5.16 Application Job messages, advanced

5.16.1 MID 0120 Job line control info subscribe

A subscription for the Job line control information. A message is sent to the integrator when the Job line control is started, for alert level 1, for alert level 2, or when the Job is finished before the alert level 2 (Job line control done).

Message sent by: Integrator
Answer: **MID 0005 Command accepted** or
MID 0004 Command error, Job line control info subscription already exists

For header description see section 2.2.2!

5.16.2 MID 0121 Job line control started

This message tells the integrator that Job Line control start has been set in the controller.

Message sent by: Controller
Answer: **MID 0125 Job line control info acknowledged**

For header description see section 2.2.2!

5.16.3 MID 0122 Job line control alert 1

This message tells the integrator that, for example, a car has reached 80% of the station and that the Job line control alert 1 is set in the controller. Only available when a job has been selected.

Message sent by: Controller
Answer: **MID 0125 Job line control info acknowledged**

For header description see section 2.2.2!

5.16.4 MID 0123 Job line control alert 2

This message tells the integrator that the Job line control alert 2 is set in the controller. Only available when a job has been selected.

Message sent by: Controller
Answer: **MID 0125 Job line control info acknowledged**

For header description see section 2.2.2!

5.16.5 MID 0124 Job line control done

This message tells the integrator that the Job has been completed before the alert level 2 was reached.

Message sent by: Controller
Answer: **MID 0125 Job line control info acknowledged**

For header description see section 2.2.2!

5.16.6 MID 0125 Job line control info acknowledge

Acknowledgement of Job line control info messages MID 0121, 0122, 0123, and 0124.

Message sent by: Integrator
Answer: None

For header description see section 2.2.2!

5.16.7 MID 0126 Job line control info unsubscribe

Unsubscribe for the Job line control info messages.

Message sent by: Integrator
Answer: **MID 0005 Command accepted** or
MID 0004 Command error, Job line control info subscription does not exist

For header description see section 2.2.2!

5.16.8 MID 0127 Abort Job

Abort the current running Job if there is one.

Message sent by: Integrator
Answer: **MID 0005 Command accepted**

For header description see section 2.2.2!

5.16.9 MID 0128 Job batch increment

Increment the Job batch if there is a current running Job.

Message sent by: Integrator
Answer: **MID 0005 Command accepted**

For header description see section 2.2.2!

5.16.10 MID 0129 Job batch decrement

Decrement the Job batch if there is a current running Job. Two revisions are available for this MID. The default revision or revision 1 does not contain any argument and always decrement the last tightening completed in a Job.

The revision 2 contains two parameters; the channel ID and parameter set ID to be decremented.

The MID is always sent to the cell master/reference.

Message sent by: Integrator
 Answer: **MID 0005 Command accepted** or
MID 0004 Command error, Job batch decrement failed (only for MID revision 2)

For header description see section 2.2.2!

(OBS! Revision 1 contains no data!)

Table 185 MID 0129 Revision 2

Parameter	Byte	Value
Channel ID	21-22	01
	23-24	The channel ID to be decremented. In case of a cell Job each controller member has a unique channel ID.
Parameter set ID	25-26	02
	27-29	The parameter set ID to be decremented in the Job

5.16.11 MID 0130 Job off

Set the controller in Job off mode or reset the Job off mode.

Message sent by: Integrator
 Answer: **MID 0005 Command accepted**

For header description see section 2.2.2!

Table 186 MID 0130 Revision 1

Parameter	Byte	Value
Data	21	Job off status is one byte long and specified by one ASCII digit: 0 = set Job off, 1 = reset Job off

5.16.12 MID 0131 Set Job line control start

The integrator can set the line control start in the controller with this message.

Message sent by: Integrator
 Answer: **MID 0005 Command accepted**

For header description see section 2.2.2!

5.16.13 MID 0132 Set Job line alert 1

The integrator can set the line control alert 1 in the controller with this message.

Message sent by: Integrator
Answer: **MID 0005 Command accepted**

For header description see section 2.2.2!

5.16.14 MID 0133 Set Job line alert 2

The integrator can set the line control alert 2 in the controller with this message.

Message sent by: Integrator
Answer: **MID 0005 Command accepted**

For header description see section 2.2.2!

5.16.15 MID 0140 Execute dynamic Job request

The integrator requests a dynamical Job to be executed i.e. the Job sent from the integrator is immediately executed (if possible) by the controller but not saved in the memory. A dynamical Job lifetime is the time for the Job to be executed. If the controller is powered off before the completion of the Job, the dynamical Job is lost.

Do note the limitation when sending this message on a serial connection due to the size of the read buffer (256 bytes) in the controller. In such case the number of programs in the Job list is limited.

The following revisions are available for this MID.

Table 187 MID 0140 Dynamic Job data revision 1

Table 188 MID 0140 Dynamic Job data revision 2

Table 189 MID 0140 Dynamic Job data revision 3

Table 191 MID 0140 Dynamic Job data revision 999

Revision 999 is equal to revision 1, but for each program in the Job list (parameter ID 04) the batch counter can be set. With that revision, it is then possible to send a “dynamic Job” not finally completed and already begun to the controller. The tightening already performed in the Job is assumed to be OK.

Message sent by: Integrator
Answer: **MID 0005 Command accepted** or
MID 0004 Command error, Not possible to execute dynamic Job

Note: A more detailed description of the error i.e. faulty Job select source or Job in off mode will be received, if an alarm subscription has been made (MID 0070).

For header description see section 2.2.2!

Table 187 MID 0140 Dynamic Job data revision 1

Parameter	Byte	Value
Job ID	21-22	01
	23-26	The Job ID is specified by four ASCII characters. Range: 0000-9999
Job name	27-28	02
	29-53	25 ASCII characters.
Number of parameter sets	54-55	03
	56-57	The number of parameter sets in the Job list, defined by two ASCII characters, range 00-99.
Job list	58-59	04
	60- (59+ N x 15)	A list of parameter sets (N=value from parameter "Number of parameter sets", max 99). Each parameter set is defined by a number of parameters separated by "." and terminated by ";" (15 bytes) according to: [Channel-ID]:[Program-ID]:[AutoSelect]:[BatchSize] :[Max Coherent NOK]; Channel ID = two ASCII characters, range 00-99 Program ID = parameter set ID or Multistage ID, three ASCII characters, range 000-999 Auto Select = One ASCII character, 1 or 0, 1=Auto Next Change, BatchSize = Two ASCII characters, range 00-99 Max Coherent NOK = Two ASCII characters, range 00-99 Example: 15:045:0:22:02;
Forced order	+2	05
	+1	One ASCII character: 0=free order, 1=forced order, 2=free and forced
Lock at Job done	+2	06
	+1	One ASCII character: 0=No, 1=Yes
Tool loosening	+2	07
	+1	Tool loosening. One ASCII character. 0=Enable, 1=Disable, 2=Enable only on NOK tightening
Repeat Job	+2	08
	+1	One ASCII character: 0=No, 1=Yes
Job batch mode/ batch count type	+2	09
	+1	The Job batch mode is the way to count the tightening in a Job; only the OK or both OK and NOK. One ASCII character. 0=only the OK tightenings are counted 1=both the OK and NOK tightenings are counted
Batch status at increment / bypass	+2	10
	+1	Batch status after performing an increment or a bypass parameter set. One ASCII character: 0=OK, 1=NOK
Decrement batch at OK loosening	+2	11
	+1	One ASCII character: 0=No, 1=Yes
Max time for first tightening	+2	12

All messages

Parameter	Byte	Value
	+4	Four ASCII digits, range 0000-9999, 0000=not used
Max time to complete Job	+2	13
		Max time to complete the entire Job. Five ASCII digits, range 00000-99999, 00000=not used
Display result at auto select	+2	14
	+4	Set the time the tightening result is kept on the display after selecting next parameter set. Four ASCII digits, range 0000-9999 seconds 0000=not used *1
Use line control	+2	15
	+1	One ASCII character: 0=No, 1=Yes
Identifier result part 1 ¹	+2	16
	+1	One ASCII character 0=Job VIN number, save the identifier that triggered in identifier result part 1 1=other
Result of non tightenings	+2	17
	+1	One ASCII character, save result after increment, bypass. 0=No, 1=Yes
Reset all identifiers at Job done	+2	18
	+1	One ASCII character: 0=No, 1=Yes
Reserved	+2	19
	+1	Reserved for Job repair. One ASCII character: 0=E, 1=G

Table 188 MID 0140 Dynamic Job data revision 2

Parameter	Byte	Value
See revision 1	21-57	See revision 1
Job list	58-59	04
	60- (59 + N x 52)	A list with up to 99 parameter sets where each parameter set is defined by a number of parameters separated by ":" and terminated by ";" (52 bytes) according to: [Channel-ID]:[Program-ID]:[AutoSelect]:[BatchSize]:[Max Coherent NOK]:[Batch Counter]:[IdentifierNumber]:[Job Step Name]:[Job Step Type]; Channel ID = two ASCII characters, range 00-99 Program ID = parameter set ID or Multistage ID, three ASCII characters, range 000-999 Auto Select = One ASCII character, 0, 1=Auto Next Change, 2=I/O, 6=Fieldbus, 8=Socket tray BatchSize = Two ASCII characters, range 00-99 Max Coherent NOK = Two ASCII characters, range 00-99 Batch counter = Two ASCII characters, range 00-99

¹ For an PF3000/4000 with Open protocol version 1.2.1 or later, this parameter is overridden and "other" is always selected.

		IdentifierNumber = Four ASCII characters, range 0000-9999 (Socket(s), EndFitting(s)...) Job Step Name = 25 ASCII characters Job Step Type = Two ASCII characters, range 00-99 Batch step = 1 Reserved = 2-6 Ex: 15:045:0:22:02:10:0107:Job Action 1 :01;
Job sequence number	+2	20
	+5	The job sequence number is unique for each job. All tightenings performed in the same job are stamped with the same job sequence number. It is specific by five ASCII digits. Range : 00000-65535

Table 189 MID 0140 Dynamic Job data revision 3

Parameter	Byte	Value
Job ID	21-22	01
	23-26	The Job ID is specified by four ASCII characters. Range: 0000-9999
Job name	27-28	02
	29-53	25 ASCII characters.
Number of parameter sets	54-55	03
	56-57	The number of parameter sets in the Job list, defined by two ASCII characters, range 00-99.
Job list	58-59	04

All messages

Parameter	Byte	Value
	60- (59+ N x 63)	<p>A list with up to 99 parameter sets where each parameter set is defined by a number of parameters separated by “:” and terminated by “,” (63 bytes) according to:</p> <p>[Channel-ID]:[Program-ID]:[AutoSelect]:[BatchSize]:[Max Coherent NOK]:[Batch Counter]:[IdentifierNumber]:[Job Step Name]:[Job Step Type]:[Tool loosening]:[Job batch mode / batch count type]:[batch status at increment / bypass]:[Decrement batch at OK]:[Current Batch Status]</p> <p>Channel ID = 2 ASCII characters, range 00-99</p> <p>Program ID = parameter set ID or Multistage ID, 3 ASCII characters, range 000-999</p> <p>Auto Select = 2 ASCII character, 0, 1=Auto Next Change, 2=I/O, 6=Fieldbus, 8=Socket tray 9=EndFittings, 10= tool display</p> <p>BatchSize = 2 ASCII characters, range 00-99</p> <p>Max Coherent NOK = 2 ASCII characters, range 00-99</p> <p>Batch counter = 2 ASCII characters, range 00-99</p> <p>IdentifierNumber = 4 ASCII characters, range 0000-9999 (Socket(s), EndFitting(s)...))</p> <p>Job Step Name = 25 ASCII characters</p> <p>Job Step Type = 2 ASCII characters, range 00-99, Batch step = 1, Reserved = 2-6</p> <p>Tool loosening = 1 ASCII character. 0=Enable, 1=Disable, 2=Enable only on NOK tightening</p> <p>Job batch mode / batch count type = 1 ASCII character. 0=only the OK tightenings are counted 1=both the OK and NOK tightenings are counted</p> <p>Batch status at increment / bypass = 1 ASCII character. Batch status after performing an increment or a bypass parameter set: 0=OK, 1=NOK</p> <p>Decrement batch after loosening : 1 ASCII character .0=Never, 1=Always, 2=After OK</p> <p>Current Batch Status = 1 ASCII character: 0 = Not started, 1 = OK, 2 = NOK</p> <p>Example: 15:045:0:22:02:00:0000:0...(25)...0:00:0:0:0:0;</p>
Forced order	+2	05

Parameter	Byte	Value
	+1	One ASCII character: 0=free order, 1=forced order, 2=free and forced
Lock at Job done	+2	06
	+1	One ASCII character: 0=No, 1=Yes
Repeat Job	+2	07
	+1	One ASCII character: 0=No, 1=Yes
Max time for first tightening	+2	08
	+4	Four ASCII digits, range 0000-9999, 0000=not used
Max time to complete Job	+2	09
	+5	Max time to complete the entire Job. Five ASCII digits, range 00000-99999, 00000=not used
Display result at auto select	+2	10
	+4	Set the time the tightening result is kept on the display after selecting next parameter set. Four ASCII digits, range 0000-9999 seconds 0000=not used
Use line control	+2	11
	+1	One ASCII character: 0=No, 1=Yes
Identifier result part 1 ¹	+2	12
	+1	One ASCII character 0=Job VIN number, save the identifier that triggered in identifier result part 1 1=other
Result of non tightenings	+2	13
	+1	One ASCII character, save result after increment, bypass. 0=No, 1=Yes
Reset all identifiers at Job done	+2	14
	+1	One ASCII character: 0=No, 1=Yes
Reserved	+2	15
	+1	Reserved for Job repair. One ASCII character: 0=E, 1=G
Job sequence number	+2	16
	+5	The job sequence number is unique for each job. All tightenings performed in the same job are stamped with the same job sequence number. It is specific by five ASCII digits. Range : 00000-65535

Table 190 MID 0140 Dynamic Job data revision 4

Parameter	Byte	Value
Job ID	21-22	01
	23-26	The Job ID is specified by four ASCII characters. Range: 0000-9999
Job name	27-28	02
	29-53	25 ASCII characters.
Number of parameter sets	54-55	03
	56-57	The number of parameter sets in the Job list, defined by two ASCII characters, range 00-99.
Job list	58-59	04

Parameter	Byte	Value
	60- (59+ N x 67)	<p>A list with up to 99 parameter sets where each parameter set is defined by a number of parameters separated by “:” and terminated by “,” (67 bytes) according to:</p> <p>[Channel-ID]:[Program-ID]:[AutoSelect]:[BatchSize]:[Max Coherent NOK]:[Batch Counter]:[IdentifierNumber]:[Job Step Name]:[Job Step Type]:[Tool loosening]:[Job batch mode / batch count type]:[batch status at increment / bypass]:[Decrement batch at OK]:[Current Batch Status]</p> <p>Channel ID = 2 ASCII characters, range 00-99</p> <p>Program ID = parameter set ID or Multistage ID, 3 ASCII characters, range 000-999</p> <p>Auto Select = 2 ASCII character, 0, 1=Auto Next Change, 2=I/O, 6=Fieldbus, 8=Socket tray 9=EndFittings, 10= tool display</p> <p>BatchSize = 4 ASCII characters, range 0000-9999</p> <p>Max Coherent NOK = 2 ASCII characters, range 00-99</p> <p>Batch counter = 4 ASCII characters, range 0000-9999</p> <p>IdentifierNumber = 4 ASCII characters, range 0000-9999 (Socket(s), EndFitting(s)...))</p> <p>Job Step Name = 25 ASCII characters</p> <p>Job Step Type = 2 ASCII characters, range 00-99, Batch step = 1, Reserved = 2-6</p> <p>Tool loosening = 1 ASCII character. 0=Enable, 1=Disable, 2=Enable only on NOK tightening</p> <p>Job batch mode / batch count type = 1 ASCII character. 0=only the OK tightenings are counted 1=both the OK and NOK tightenings are counted</p> <p>Batch status at increment / bypass = 1 ASCII character. Batch status after performing an increment or a bypass parameter set: 0=OK, 1=NOK</p> <p>Decrement batch after loosening : 1 ASCII character .0=Never, 1=Always, 2=After OK</p> <p>Current Batch Status = 1 ASCII character: 0 = Not started, 1 = OK, 2 = NOK</p> <p>Example: 15:045:00:0022:02:0000:0000:0...(25)...0:00:0:0:0:0;</p>
Forced order	+2	05

All messages

Parameter	Byte	Value
	+1	One ASCII character: 0=free order, 1=forced order, 2=free and forced
Lock at Job done	+2	06
	+1	One ASCII character: 0=No, 1=Yes
Repeat Job	+2	07
	+1	One ASCII character: 0=No, 1=Yes
Max time for first tightening	+2	08
	+4	Four ASCII digits, range 0000-9999, 0000=not used
Max time to complete Job	+2	09
	+5	Max time to complete the entire Job. Five ASCII digits, range 00000-99999, 00000=not used
Display result at auto select	+2	10
	+4	Set the time the tightening result is kept on the display after selecting next parameter set. Four ASCII digits, range 0000-9999 seconds 0000=not used
Use line control	+2	11
	+1	One ASCII character: 0=No, 1=Yes
Identifier result part 1 ¹	+2	12
	+1	One ASCII character 0=Job VIN number, save the identifier that triggered in identifier result part 1 1=other
Result of non tightenings	+2	13
	+1	One ASCII character, save result after increment, bypass. 0=No, 1=Yes
Reset all identifiers at Job done	+2	14
	+1	One ASCII character: 0=No, 1=Yes
Reserved	+2	15
	+1	Reserved for Job repair. One ASCII character: 0=E, 1=G
Job sequence number	+2	16
	+5	The job sequence number is unique for each job. All tightenings performed in the same job are stamped with the same job sequence number. It is specific by five ASCII digits. Range : 00000-65535

MID 0140 Dynamic Job data revision 999 is equal to revision 1 except for parameter ID 04, Job list.

Table 191 MID 0140 Dynamic Job data revision 999

Parameter	Byte	Value
See revision 1	21-57	See revision 1
Job list	58-59	04
	60- (60 + N x 18)	A list with up to 99 parameter sets where each parameter set is defined by a number of parameters separated by ":" and terminated by ";" (18 bytes) according to: [Channel-ID]:[Program-ID]:[AutoSelect]:[BatchSize]:[Max Coherent NOK]:[Batch Counter]; Channel ID = two ASCII characters, range 00-99 Program ID = parameter set ID or Multistage ID, three ASCII characters, range 000-999 Auto Select = One ASCII character, 1 or 0, 1=Auto Next Change, BatchSize = Two ASCII characters, range 00-99 Max Coherent NOK = Two ASCII characters, range 00-99 Batch counter = Two ASCII characters, range 00-99 Ex: 15:045:0:22:02:10;
See revision 1		See revision 1

5.17 Application Multiple identifiers messages

5.17.1 MID 0150 Identifier download request

Used by the integrator to send an identifier to the controller.

Message sent by: Integrator
Answer: **MID 0005 Command accepted** or
MID 0004 Command error, Identifier input source not granted

For header description see section 2.2.2!

Table 192 MID 0150 Revision 1

Parameter	Byte	Value
Identifier data	21-max 120	Max 100 ASCII characters

5.17.2 MID 0151 Multiple identifier and result parts subscribe

This message is used by the integrator to set a subscription for the work order status, optional identifiers and result parts extracted from the identifiers received and accepted by the controller. The identifiers may have been received by the controller from one or several input sources (Serial, Ethernet, Fieldbus, ST scanner etc.).

Message sent by: Integrator
Answer: **MID 0005 Command accepted** or
MID 0004 Command error, Multiple identifier and result parts subscription already exists

For header description see section 2.2.2!

5.17.3 MID 0152 Multiple identifier and result parts

Transmission of the work order status, optional identifier and identifier result parts by the controller to the subscriber.

The identifier contains the status of the maximum four identifier result parts that could be extracted from one or more valid identifiers.

Message sent by: Controller
Answer: **MID 0153 Multiple identifiers and result parts acknowledge**

For header description see section 2.2.2!

Table 193 MID 0152 Multiple identifier and result parts data, Revision 1

Parameter	Byte	Value
First identifier status In Work order	21-22	01
	23-52	Byte 1: Identifier type number: Range 1-4 Byte 2-3: Included in work order: 0=No, 1=Yes Byte 4-5: Status in work order: 0=Not accepted, 1=Accepted, 2=Bypassed, 3=Reset, 4=Next, 5=Initial Byte 6-30: Result part 1
Second identifier status In Work order	53-54	02
	55-84	Byte 1: Identifier type number: Range 1-4 Byte 2-3: Included in work order: 0=No, 1=Yes Byte 4-5: Status in work order: 0=Not accepted, 1=Accepted, 2=Bypassed, 3=Reset, 4=Next, 5=Initial Byte 6-30: Result part 2
Third identifier status In Work order	85-86	03
	87-116	Byte 1: Identifier type number: Range 1-4 Byte 2-3: Included in work order: 0=No, 1=Yes Byte 4-5: Status in work order: 0=Not accepted, 1=Accepted, 2=Bypassed, 3=Reset, 4=Next, 5=Initial Byte 6-30: Result part 3
Fourth identifier status In Work order	117-118	03
	119-148	Byte 1: Identifier type number: Range 1-4 Byte 2-3: Included in work order: 0=No, 1=Yes Byte 4-5: Status in work order: 0=Not accepted, 1=Accepted, 2=Bypassed, 3=Reset, 4=Next, 5=Initial Byte 6-30: Result part 4

5.17.4 MID 0153 Multiple identifiers and result parts acknowledge

Acknowledgement of multiple identifiers and result parts upload.

Message sent by: Integrator
Answer: None

For header description see section 2.2.2!

5.17.5 MID 0154 Multiple identifier and result parts unsubscribe

Reset the subscription for the multiple identifiers and result parts.

Message sent by: Integrator
Answer: **MID 0005 Command accepted** or
MID 0004 Command error, Multiple identifiers and result parts subscription does not exist

For header description see section 2.2.2!

5.17.6 MID 0155 Bypass Identifier

This message is used by the integrator to bypass the next identifier expected in the work order.

Message sent by: Integrator
Answer: **MID 0005 Command accepted**

For header description see section 2.2.2!

5.17.7 MID 0156 reset latest Identifier

This message is used by the integrator to reset the latest identifier or bypassed identifier in the work order.

Message sent by: Integrator
Answer: **MID 0005 Command accepted**

For header description see section 2.2.2!

5.17.8 MID 0157 reset all Identifiers

This message is used by the integrator to reset all identifiers in the current work order.

Message sent by: Integrator
Answer: **MID 0005 Command accepted**

For header description see section 2.2.2!

5.17.9 MID 1601 Dynamic identifier message

This MID contains data for subscribed identifiers to be sent dynamically. Each message can therefore consist of different type of identifiers and the PID in the variable data field always need to be checked to know the identifier type.

When identifiers are set, the corresponding data is expected to be published.

For data field that is sent by controller, see section 5.17.9.3.

Message sent by: Controller
Answer: **MID 1602 Dynamic identifier data acknowledge or
MID 0005 with MID 1601 in the data field.
If the sequence number acknowledge functionality is used
there is no need for these acknowledgements.**

For header description see section 2.2.2!

5.17.9.1 Subscription, MID 1601

Use MID 0008 to start subscription, Table 194 shows the content in the “Extra data” field.

Message sent by: Integrator

Answer: **MID 0005 Command accepted with MID 1601 in the data field or
MID 0004 Command error with MID 1601 in the data field with error code,
Subscription on specific data not supported or Invalid data.**

Table 194 MID 1601 Subscription extra data

Parameter	Size [byte]	Data type	Description
Send alternatives	1	UI	Following alternatives are available. One ASCII digit 0=All identifier types device supports, 1= All VIN/result related identifier types, 2=Dynamically specified identifiers If = 0 then the device will send back all type of identifiers it supports, check specification for the specific device, no additional data is needed. If = 1 then result related identifiers will be sent, can be compared with the old MID 0052 and MID 0152. Check with device specification for which identifiers it supports. No additional data needed. If = 2 The integrator has the possibility to specify which identifiers it is interested in. See additional data below for structure.
Format type	1	UI	Following alternatives are available. One ASCII digit 0 = Send only identifier 1 = Send result related identifiers according to MID 0152, rest unaffected 2 = Send identifier name for identifiers
STRUCTURE FOR SEND ALTERNATIVE 2			
Number of identifiers	3	UI	The number of the different type of identifiers wanted. Specification of these are done in the field below.
PIDs of wanted identifier types	Vary (Number of identifiers*5)	UI	A list of PIDs for the type of identifiers that are wanted.

5.17.9.2 Unsubscription, MID 1601

Use MID 0009 to unsubscribe. No “Extra data” field shall be sent.

Example

```
002900090010 00 160100100NUL
```

5.17.9.3 Data field of MID 1601

When controller send new information to integrator, the data shall be sent according to data field in Table 195.

Table 195 MID 1601 Data field, revision 1

Parameter	Size [byte]	Data type	Description
Total no of messages	3	UI	The total number of messages needed to send all data for all identifiers.
Message number	3	UI	This parameter will specify which message this is in the transmission of the identifiers.
Format type	1	UI	Following alternatives are available. One ASCII digit 0 = Send only identifier 1 = Send result related identifiers according to MID 0152, rest unaffected 2 = Send identifier name for identifiers (the name and the identifier will be separated with a : colon or divider specified by the specific device)
Number of data fields	3	UI	The number of variable data fields in the telegram. If no data fields exist "000" will be sent. Each identifier type has its own data field where the PID is specifying the identifier type.
Data fields		Vary	This section is repeated Number of data fields times. If Number of data fields = 000, this section is not sent. The structure is of variable parameter type see Variable Data Field Use in section 2.4.

See suggestion on supported PIDs in Table 196. Consult device specific documentation for device supported PIDs.

Table 196 MID 1601 Suggested PIDs to support

Parameter id (PID)	Name	Description
<i>Identifiers</i>		
00010	VIN Number	The VIN number for the tightening
00011	Identifier 1	Identifier 1 used for the tightening. Could for example be a pallet number, identity of the operator, identification for the part, etc...
00012	Identifier 2	...
00013	Identifier 3	...
00014	Identifier 4	...
00015	Identifier 5	...
00016	Identifier 6	...
00017	Identifier 7	...
00018	Identifier 8	...
00019	Identifier 9	...
00020	Identifier 10	Identifier 10 used for the tightening. Could for example be a pallet number, identity of the operator, identification for the part, etc...
00060	Scanned Barcode	Scanned barcode that is not handled by the system but just passed on to the integrator

5.17.10 MID 1602 Dynamic identifier data acknowledge

Acknowledgement for MID 1601, Dynamic identifier data.

Message sent by: Integrator

Answer: **None**

For header description see section 2.2.2!

5.17.11 Example of use, MID 1601

Message for dynamic identifier is highly dynamic. Consult each device documentation for fully description on supported functionality. This section will only show an example of use.

5.17.11.1 Subscribe on all supported identifier from device

This example will show how subscribe message and data message for all supported identifiers might look. In this example VIN, Scanned Barcode and Identifier 1 and 2 are sent from the system.

Number of identifiers in message = **RED**

PID = **GREEN**

Length of identifier = **YELLOW**

Identifier = **BLUE**

To subscribe, sent from Integrator

```
003100080010  00  16010010200NUL
```

Sent from Controller when VIN, ABC is sent

```
0050160100100000  001001000100010003040000000ABCNUL
```

Sent from Controller when Scanned Barcode DEF is sent

```
0050160100100000  001001000100060003040000000DEFNUL
```

Sent from Controller when Identifier 1 and 2 is sent in same message

```
0070160100100000  0010010002  
00011003040000000ABC00012003040000000DEFNUL
```

Integrator shall send acknowledgement with MID 1602 in all cases above sent from controller. If no acknowledgement is wanted this shall be set when subscribing with MID 0008

```
002016020010  00  NUL
```

5.17.11.2 Subscribe on specific identifier

In this example, the Integrator is only interesting in the Scanned Barcode. Instead, the VIN message is subscribed with MID 0050.

Number of identifiers in message = RED

PID = GREEN

Length of identifier = YELLOW

Identifier = BLUE

Send alternative = PINK

To subscribe MID 1601, sent from Integrator

```
003900080010 00 1601001102000100060NUL
```

Sent from system when Scanned Barcode ABCGHI is sent

```
0053160100100000 001001000100060006040000000ABCGHINUL
```

Integrator shall send acknowledgement with MID 1602. If no acknowledgement is wanted this shall be set when subscribing with MID 0008

```
002016020010 00 NUL
```

5.17.11.3 Subscribe on two specific identifiers with format type

The Integrator can subscribe on multiple specific identifiers and request to get label/name for each identifier. Consult the device documentation regarding what format type is supported, how label/names are configured and which divider that is used.

Number of identifiers in message = RED

PID = GREEN

Length of identifier = YELLOW

Identifier = BLUE

Identifier Name = DARK BLUE

Send alternative = PINK

Format type = PURPLE

To subscribe, sent from Integrator

```
004400080010 00 160100115220020001100012NUL
```

Sent from Controller when Identifier 1 and 2 is sent in same message

```
0089160100100000 0010012002  
00011014040000000Part no:ABCGHI00012011040000000User id:DEFNUL
```

Integrator shall send acknowledgement with MID 1602. If no acknowledgement is wanted this shall be set when subscribing with MID 0008

```
002016020010 00 NUL
```

5.18 Application I/O Interface

5.18.1 MID 0200 Set externally controlled relays

By using this message the integrator can control 10 relays (externally control relays). The station can set, reset the relays or make them flashing.

Message sent by: Integrator
 Answer: **MID 0005 Command accepted**

Example: Reset relay 1, set relay 2, reset relay 3, flash relay 4, keep relay 5 as it is, reset relay 6, set relay 7, flash relay 8, keep relay 9 as it is, and reset relay 10.

00300200	0102301230NUL
----------	---------------

For header description see section 2.2.2!

Table 197 MID 0200 Relay status revision 1

Parameter	Byte	Value
Status relay 1	21	Set the status for relay 1. The relay status is one byte long and specified by 1 ASCII digit. Range 0-3. 0=Off (reset), 1=On (set, fast), 2=Flashing, 3=Keep current status
Status relay 2	22	Set the status for relay 2. The relay status is one byte long and specified by 1 ASCII digit. Range 0-3. 0=Off (reset), 1=On (set, fast), 2=Flashing, 3=Keep current status
Status relay 3	23	Set the status for relay 3. The relay status is one byte long and specified by 1 ASCII digit. Range 0-3. 0=Off (reset), 1=On (set, fast), 2=Flashing, 3=Keep current status
Status relay 4	24	Set the status for relay 4. The relay status is one byte long and specified by 1 ASCII digit. Range 0-3. 0=Off (reset), 1=On (set, fast), 2=Flashing, 3=Keep current status
Status relay 5	25	Set the status for relay 5. The relay status is one byte long and specified by 1 ASCII digit. Range 0-3. 0=Off (reset), 1=On (set, fast), 2=Flashing, 3=Keep current status
Status relay 6	26	Set the status for relay 6. The relay status is one byte long and specified by 1 ASCII digit. Range 0-3. 0=Off (reset), 1=On (set, fast), 2=Flashing, 3=Keep current status
Status relay 7	27	Set the status for relay 7. The relay status is one byte long and specified by 1 ASCII digit. Range 0-3. 0=Off (reset), 1=On (set, fast), 2=Flashing, 3=Keep current status

Parameter	Byte	Value
Status relay 8	28	Set the status for relay 8. The relay status is one byte long and specified by 1 ASCII digit. Range 0-3. 0=Off (reset), 1=On (set, fast), 2=Flashing, 3=Keep current status
Status relay 9	29	Set the status for relay 9. The relay status is one byte long and specified by 1 ASCII digit. Range 0-3. 0=Off (reset), 1=On (set, fast), 2=Flashing, 3=Keep current status
Status relay 10	30	Set the status for relay 10. The relay status is one byte long and specified by 1 ASCII digit. Range 0-3. 0=Off (reset), 1=On (set, fast), 2=Flashing, 3=Keep current status

5.18.2 MID 0210 Status externally monitored inputs subscribe

By using this message the integrator can set a subscription to monitor the status for the eight externally monitored digital inputs. After the subscription the station will directly receive a status message and then every time the status of at least one of the inputs has changed.

Message sent by: Integrator

Answer: **MID 0005 Command accepted** or
MID 0004 Command error,
Status externally monitored inputs subscription already exists or
MID 0211 Status externally monitored inputs.

For header description see section 2.2.2!

5.18.3 MID 0211 Status externally monitored inputs

Status for the eight externally monitored digital inputs. This message is sent to the subscriber every time the status of at least one of the inputs has changed.

Message sent by: Controller
 Answer: MID 0212 Status externally monitored inputs acknowledge

Example:

00280211	00100111NUL
----------	-------------

For header description see section 2.2.2!

Table 198 MID 0211 Digital input status revision 1

Parameter	Byte	Value
Status DIG/IN 1	21	The DIG/IN status is one byte long and specified by 1 ASCII digits. Range 0-1. 0=Off, 1=On
Status DIG/IN 2	22	The DIG/IN status is one byte long and specified by 1 ASCII digits. Range 0-1. 0=Off, 1=On
Status DIG/IN 3	23	The DIG/IN status is one byte long and specified by 1 ASCII digits. Range 0-1. 0=Off, 1=On
Status DIG/IN 4	24	The DIG/IN status is one byte long and specified by 1 ASCII digits. Range 0-1. 0=Off, 1=On
Status DIG/IN 5	25	The DIG/IN status is one byte long and specified by 1 ASCII digits. Range 0-1. 0=Off, 1=On
Status DIG/IN 6	26	The DIG/IN status is one byte long and specified by 1 ASCII digits. Range 0-1. 0=Off, 1=On
Status DIG/IN 7	27	The DIG/IN status is one byte long and specified by 1 ASCII digits. Range 0-1. 0=Off, 1=On
Status DIG/IN 8	28	The DIG/IN status is one byte long and specified by 1 ASCII digits. Range 0-1. 0=Off, 1=On

5.18.4 MID 0212 Status externally monitored inputs acknowledge

Acknowledgement for the message status externally monitored inputs upload.

Message sent by: Integrator
 Answer: None

For header description see section 2.2.2!

5.18.5 MID 0213 Status externally monitored inputs unsubscribe

Unsubscribe for the MID 0211 Status externally monitored inputs.

Message sent by: Integrator
 Answer: MID 0005 Command accepted or
 MID 0004 Command error,
 Status externally monitored inputs subscription does not exist

For header description see section 2.2.2!

5.18.6 MID 0214 IO device status request

Request for the status of the relays and digital inputs at a device, e.g. an I/O expander. The device is specified by a device number.

Message sent by: Integrator
 Answer: MID 0215 IO device status or
 MID 0004 Command error,
 Faulty IO device ID, or IO device not connected

For header description see section 2.2.2!

Table 199 MID 0214 Revision 1 and 2

Parameter	Byte	Value
Device number	21-22	Two ASCII characters (00-15) 00=internal device, 01-15=I/O expanders

5.18.7 MID 0215 IO device status reply

This message is sent as an answer to the **MID 0214 IO device status request**.

MID 0215 revision 1 should only be used to get the status of IO devices with max 8 relays/digital inputs.

For I/O devices the list contain up to 8 relays/digital inputs. For I/O devices with less relays/digital inputs, the last items shall be empty (zero).

MID 0215 revision 2 can be used to get the status of all types of IO devices with a maximum number of relays/digital inputs specified by the device.

Message sent by: Controller
 Answer: None

For header description see section 2.2.2!

See Table 202 for interpretation of relay function numbers and digital input function numbers. Note that one or two zeroes have to be added in front of the numbers in the list in this MID. For example relay number 13 Job NOK must be entered as 013.

Table 200 MID 0215 Revision 1

Parameter	Byte	Value
IO device ID	21-22	01
	23-24	The IO device ID specified with two ASCII characters. Range: 00-99. 00=internal device, 01-15=I/O expanders.
Relay list	25-26	02
	27-58	A list of 8 relays for the current device ID. Each relay is specified by four bytes. Byte 1-3: Relay function number, three ASCII characters, range 000-999 Byte 4: Relay status specified by one ASCII character; 0=reset, 1=set.
Digital Input list	59-60	03
	61-92	A list of 8 digital inputs for the current device ID. Each digital input is specified by four bytes. Byte 1-3: Digital input function number, three ASCII characters, range 000-999 Byte 4: Digital input status specified by one ASCII character. 0=Low, 1=High

Table 201 MID 0215 Revision 2

Parameter	Byte	Value
IO device ID	21-22	01
	23-24	The IO device number specified with two ASCII characters. Range: 00-99. 00=internal device, 01-15=I/O expanders.
Number of relays	25-26	02
	27-28	Number of relays present on the I/O-device.
Relay list	29-30	03
	31- X ²	A list of relays for the current device ID. Each relay is specified by four bytes. Byte 1-3: Relay function number, three ASCII characters, range 000-999 Byte 4: Relay status specified by one ASCII character; 0=reset, 1=set.
Number of digital inputs	X+1-X+2	04
	X+3-X+4	Number of digital inputs present on the I/O-device.
Digital Input list	X+5-X+6	05
	X+7-Y ³	A list of digital inputs for the current device ID. Each digital input is specified by four bytes. Byte 1-3: Digital input function number, three ASCII characters, range 000-999 Byte 4: Digital input status specified by one ASCII character. 0=Low, 1=High

² X = 31 + 4*Number of relays present³ Y = X + 8 + 4*Number of digital inputs present

Please observe that Table 202 and Table 203 are a generic specification. Any application/device specific appendix might override the meaning of any Relay or DigIN function!

Table 202 MID 0215 Relay number

Relay number	Relay function	Tracking event	Description
00	Off		
01	OK		
02	NOK		
03	Low		
04	High		
05	Low Torque		
06	High Torque		
07	Low angle		
08	High angle		
09	Cycle complete		
10	Alarm	Yes	
11	Batch NxOK	Yes	
12	Job OK	Yes	
13	Job NOK	Yes	
14	Job running	Yes	
15	Reserved	Yes	
16	Reserved	Yes	
17	Tool health OK	Yes	
18	POWER FOCUS ready	Yes	
19	Tool ready	Yes	
20	Tool start switch	Yes	
21	Dir. Switch = CW	Yes	
22	Dir. Switch = CCW	Yes	
23	Tightening direction CCW	Yes	
24	Tool tightening	Yes	
25	Tool loosening	Yes	
26	Tool running	Yes	
27	Tool running CW	Yes	
28	Tool running CCW	Yes	
29	Statistic alarm	Yes	
30	Tool locked	Yes	
31	Received identifier		
32	Running Pset bit 0	Yes	
33	Running Pset bit 1	Yes	
34	Running Pset bit 2	Yes	
35	Running Pset bit 3	Yes	
36	Running Job bit 0	Yes	
37	Running Job bit 1	Yes	

Relay number	Relay function	Tracking event	Description
38	Running Job bit 2	Yes	
39	Running Job bit 3	Yes	
40	Not used		
41	Not used		
42	Not used		
43	Not used		
44	Line control OK		
45	Line control alert 1		
46	Line control alert 2		
47	Service indicator	Yes	
48	Fieldbus relay 1	Yes	
49	Fieldbus relay 2	Yes	
50	Fieldbus relay 3	Yes	
51	Fieldbus relay 4	Yes	
52	Tool red light	Yes	
53	Tool green light	Yes	
54	Tool yellow light	Yes	
55	Reserved	Yes	
56	Reserved	Yes	
57	Reserved	Yes	
58	Reserved	Yes	
59	Running Pset bit 4	Yes	
60	Running Pset bit 5	Yes	
61	Running Pset bit 6	Yes	
62	Running Pset bit 7	Yes	
63	Running Job bit 4	Yes	
64	Running Job bit 5	Yes	
65	Running Job bit 6	Yes	
66	Running Job bit 7	Yes	
67	Sync OK		
68	Sync NOK		
69	Sync spindle 1 OK		
70	Sync spindle 1 NOK		
71	Sync spindle 2 OK		
72	Sync spindle 2 NOK		
73	Sync spindle 3 OK		
74	Sync spindle 3 NOK		
75	Sync spindle 4 OK		
76	Sync spindle 4 NOK		
77	Sync spindle 5 OK		
78	Sync spindle 5 NOK		

All messages

Relay number	Relay function	Tracking event	Description
79	Sync spindle 6 OK		
80	Sync spindle 6 NOK		
81	Sync spindle 7 OK		
82	Sync spindle 7 NOK		
83	Sync spindle 8 OK		
84	Sync spindle 8 NOK		
85	Sync spindle 9 OK		
86	Sync spindle 9 NOK		
87	Sync spindle 10 OK		
88	Sync spindle 10 NOK		
89	Reserved	Yes	
90	Reserved		
91	Line Control Start	Yes	
92	Job Aborted	Yes	
93	External controlled 1		
94	External controlled 2		
95	External controlled 3		
96	External controlled 4		
97	External controlled 5		
98	External controlled 6		
99	External controlled 7		
100	External controlled 8		
101	External controlled 9		
102	External controlled 10		
103	ToolsNet connection lost	Yes	
104	Open Protocol connection lost	Yes	
105	FieldBus Offline	Yes	
106	Home position	Yes	
107	Batch NOK	Yes	
108	Selected Channel in Job	Yes	
109	Safe to disconnect tool	Yes	
110	Running Job bit 8	Yes	
111	Running Pset bit 8	Yes	
112	Calibration Alarm	Yes	
113	Cycle start		
114	Low current		
115	High current		
116	Low PVT monitoring		
117	High PVT monitoring		
118	Low PVT self-tap		
119	High PVT self-tap		

Relay number	Relay function	Tracking event	Description
120	Low tightening angle		
121	High tightening angle		
122	Identifier identified		
123	Identifier type 1 received		
124	Identifier type 2 received		
125	Identifier type 3 received		
126	Identifier type 4 received		
127	Reserved		
128	Reserved		
129	Ring button ack.		
130	DigIn controlled 1	Yes	
131	DigIn controlled 2	Yes	
132	DigIn controlled 3	Yes	
133	DigIn controlled 4	Yes	
134	Fieldbus carried signals disabled	Yes	
135	Illuminator	Yes	
136	New parameter set selected		
137	New Job selected		
138	Job OFF relay	Yes	
139	Logic relay 1	Yes	
140	Logic relay 2	Yes	
141	Logic relay 3	Yes	
142	Logic relay 4	Yes	
143	Max coherent NOK reached	Yes	
144	Batch done	Yes	
145	Start trigger active	Yes	
146	Reserved	Yes	
150-250	Reserved		
251	Completed Batch bit 0	Yes	
252	Completed Batch bit 1	Yes	
253	Completed Batch bit 2	Yes	
254	Completed Batch bit 3	Yes	
255	Completed Batch bit 4	Yes	
256	Completed Batch bit 5	Yes	
257	Completed Batch bit 6	Yes	
258	Reserved	Yes	
259	Remaining Batch bit 0	Yes	
260	Remaining Batch bit 1	Yes	
261	Remaining Batch bit 2	Yes	
262	Remaining Batch bit 3	Yes	
263	Remaining Batch bit 4	Yes	

All messages

Relay number	Relay function	Tracking event	Description
264	Remaining Batch bit 5	Yes	
265	Remaining Batch bit 6	Yes	
266	Reserved	Yes	
267	Reserved	Yes	
268	Reserved	Yes	
269	Reserved	Yes	
270	Reserved	Yes	
271	Reserved		
272	Reserved	Yes	
273	Reserved	Yes	
274	Reserved	Yes	
275	Open Protocol commands disabled	Yes	
276	Cycle abort		
277	Effective loosening		
278	Logic relay 5	Yes	
279	Logic relay 6	Yes	
280	Logic relay 7	Yes	
281	Logic relay 8	Yes	
282	Logic relay 9	Yes	
283	Logic relay 10	Yes	
284	Lock at batch done	Yes	
285	Reserved		
286	Reserved		
287	Battery low	Yes	
288	Battery empty	Yes	
289	Tool connected	Yes	
290	No tool connected	Yes	
291	Reserved	Yes	
292	Reserved	Yes	
293	Function button	Yes	
294	Rehit		
295	Tightening disabled	Yes	
296	Loosening disabled	Yes	
297	Positioning disabled	Yes	
298	Motor tuning disabled	Yes	
299	Open End tuning disabled	Yes	
300	Tracking disabled	Yes	
301	Reserved	Yes	
302	Automatic mode	Yes	
303	PLUS Emergency mode	Yes	
304	Wear indicator	Yes	

Relay number	Relay function	Tracking event	Description
305	Direction alert	Yes	
306	PLUS Bolt reworked		
307	Line stop	Yes	
308	Running pset bit 9	Yes	
309	Active XML Result Ack	Yes	
310	Tool in work space	Yes	
311	Tool in product space	Yes	
312	XML protocol active	Yes	
313	Tool enabled by XML	Yes	
314	Necking failure	Yes	
315	PLUS protocol not active	Yes	
316	PLUS No tightening	Yes	
317	Tag ID error	Yes	
318	Job abortion in progress	Yes	
319	Stop Tightening	Yes	
320	Slow down tightening	Yes	
321-350	Reserved		
351	Middle course trigger active	Yes	
352	Front trigger active	Yes	
353	Reverse trigger active	Yes	
354	Running Job bit 9	Yes	
355	Tool Unlocked	Yes	
356	License server connection lost	Yes	Indicates that the connection to the Atlas Copco license server has been lost or the synchronization has failed. The signal is cleared when the License manager synchronization has been done successfully
357	Tightening externally enabled	Yes	Tightening not disabled by external source
358	Tightening externally disabled	Yes	Tightening disabled by external source
359	Loosening externally enabled	Yes	Loosening not disabled by external source
360	Loosening externally disabled	Yes	Loosening disabled by external source

All messages

Relay number	Relay function	Tracking event	Description
361	Program end	Yes	Multistep tightening program has ended, torque has fallen below Program end torque configured.
362	Pulse tool alarm oil level empty	Yes	Oil level supervision configured in the tool maintenance to remind the users when it is time to fill up oil in a pulse tool.
363	Tightening time high	Yes	Indicates high tightening time resulting in NOK tightening
364	Tightening time low	Yes	Indicates low tightening time resulting in NOK tightening
365	Tool function button pressed	yes	Output signal tracking the function button state. The signal is set when the function button is pressed and is cleared when the function button is released.

Table 203 MID 0215 DigIn number

DigIN number	DigIN function
00	Off
01	Reset batch
02	Unlock tool
03	Tool disable n.o.
04	Tool disable n.c.
05	Tool tightening disable
06	Tool loosening disable
07	Remote start pulse
08	Remote start cont.
09	Tool start loosening
10	Batch increment
11	Bypass Pset
12	Abort Job
13	Job off
14	parameter set toggle
15	Reset relays
16	parameter set select bit 0

DigIN number	DigIN function
17	parameter set select bit 1
18	parameter set select bit 2
19	parameter set select bit 3
20	Job select bit 0
21	Job select bit 1
22	Job select bit 2
23	Job select bit 3
24	Reserved
25	Reserved
26	Reserved
27	Reserved
28	Line control start
29	Line control alert 1
30	Line control alert 2
31	Ack error message
32	Fieldbus digin 1
33	Fieldbus digin 2
34	Fieldbus digin 3
35	Fieldbus digin 4
36	Flash tool green light
37	Reserved
38	Reserved
39	Reserved
40	Reserved
41	Reserved
42	Reserved
43	Manual Mode
44	Reserved
45	parameter set select bit 4
46	parameter set select bit 5
47	parameter set select bit 6
48	parameter set select bit 7
49	Job select bit 4
50	Job select bit 5
51	Job select bit 6
52	Job select bit 7
53	Batch decrement
54	Job restart
55	End of cycle
56	Reserved
57	Reserved

All messages

DigIN number	DigIN function
58	Reserved
59	Reserved
60	Reserved
61	Reserved
62	Click wrench 1
63	Click wrench 2
64	Click wrench 3
65	Click wrench 4
66	ID Card
67	Automatic mode
68	External monitored 1
69	External monitored 2
70	External monitored 3
71	External monitored 4
72	External monitored 5
73	External monitored 6
74	External monitored 7
75	External monitored 8
76	Select next parameter set
77	Select previous parameter set
78	Reserved
79	Timer enable tool
80	Master unlock tool
81	ST Scan request
82	Disconnect tool
83	Job select bit 8
84	Parameter set select bit 8
85	Request ST scan
86	Reset NOK counter
87	Bypass identifier
88	Reset latest identifier
89	Reset all identifier
90	Set home position
91	DigOut monitored 1
92	DigOut monitored 2
93	DigOut monitored 3
94	DigOut monitored 4
95	Disable ST Scanner
96	Disable fieldbus carried signals
97	Toggle CW/CCW
98	Toggle CW/CCW for next run

DigIN number	DigIN function
99	Set CCW
100	Reserved
101	Reserved
102	Reserved
103	Reserved
104	Open Protocol commands disable
105	Logic dig In 1
106	Logic dig In 2
107	Logic dig In 3
108	Logic dig In 4
109	Logic dig In 5
110	Logic dig In 6
111	Logic dig In 7
112	Logic dig In 8
113	Logic dig In 9
114	Logic dig In 10
115	Reserved
116	Reserved
117	Reserved
118	Reserved
119	Reserved
120	Forced CCW once
121	Forced CCW toggle
122	Forced CW once
123	Forced CW toggle
124	Reserved
125	Reserved
126	Reserved
127	Reserved
128	Reserved
129	Pset select bit 9
130	Store current tightening program in the tool
131	Active XML result send
132	Tool in work space
133	Tool in product space
134	Flash tool yellow light
135	XML Emergency mode
136	MFU Test
137	Tool in park position
138	Enable operation
139	Stop tightening

DigIN number	DigIN function
140	Start loosening pulse
141-149	Free to use
150	Pulsor Tool enable
151	Perform air hose test
152	Last Digin
150-200	Reserved for Pulsor
201	Tool blue light IO controlled
202	Tool blue light
203	Tool green light IO controlled
204	Tool green light
205	Tool red light IO controlled
206	Tool red light
207	Tool yellow light IO controlled
208	Tool yellow light
209	Tool white light IO controlled
210	Tool white light
300-349	Reserved

5.18.8 MID 0216 Relay function subscribe

Subscribe for one single relay function. The data field consists of three ASCII digits, the relay number, which corresponds to the specific relay function. The relay numbers can be found in Table 202 above. At a subscription of a tracking event, **MID 0217 Relay function** immediately returns the current relay status to the subscriber.

MID 0216 can only subscribe for one single relay function at a time, but still, Open Protocol supports keeping several relay function subscriptions simultaneously.

Message sent by: Integrator

Answer: **MID 0005 Command accepted** or
MID 0004 Command error, The relay function subscription already exists

For header description see section 2.2.2!

Table 204 MID 0216 Revision 1

Parameter	Byte	Value
Relay function number	21-23	Three ASCII digits, see Table 202 and add 0 before the number in the list.

5.18.9 MID 0217 Relay function

Upload of one specific relay function status, see Table 202.

For tracking event functions, **MID 0217 Relay function**, is sent each time the relay status is changed. For relay functions which are not tracking events, the upload is sent only when the relay is set high, i.e. the data field “Relay function status” will always be 1 for such functions.

Message sent by: Controller

Answer: **MID 0218 Relay function acknowledge**

For header description see section 2.2.2!

Table 205 MID 0217 Relay no and status Revision 1

Parameter	Byte	Value
Relay function no	21-22	01
	23-25	Three ASCII digits corresponding to a relay function. See Table 202 and add 0 before the number in the list.
Relay function status	26-27	02
	28	One ASCII digit representing the relay function status: 1=active 0=not active.

5.18.10 MID 0218 Relay function acknowledge

Acknowledgement of relay function upload.

Message sent by: Integrator

Answer: None

For header description see section 2.2.2!

5.18.11 MID 0219 Relay function unsubscribe

Unsubscribe for a single relay function. The data field consists of three ASCII digits, the relay number, which corresponds to the specific relay function. The relay numbers can be found in Table 202.

Message sent by: Integrator
Answer: **MID 0005 Command accepted** or
MID 0004 Command error, The relay function subscription does not exist

For header description see section 2.2.2!

Table 206 MID 0219 Revision 1

Parameter	Byte	Value
Relay function number	21-23	Number shall have three digits and left padded with zeroes if necessary, see Table 202.

5.18.12 MID 0220 Digital input function subscribe

Subscribe for one single digital input function. The data field consists of three ASCII digits, the digital input function number. The digital input function numbers can be found in Table 203 above. At a subscription of a tracking event, **MID 0221 Digital input function upload** immediately returns the current digital input function status to the subscriber.

MID 0220 can only subscribe for one single digital input function at a time, but still, Open Protocol supports keeping several digital input function subscriptions simultaneously.

Message sent by: Integrator
Answer: **MID 0005 Command accepted** or
MID 0004 Command error, The digital input function subscription already exists

Table 207 MID 0220 Revision 1

Parameter	Byte	Value
Digital input function number	21-23	Three ASCII digits, see Table 203 and add 0 before the number in the list.

5.18.13 MID 0221 Digital input function

Upload of one specific digital input function status. See Table 203.

For tracking event functions, **MID 0221 Digital input function**, is sent each time the digital input function's status (state) is changed. For digital input functions which are not tracking events, the upload is sent only when the digital input function is set high, i.e. the data field "Digital input function status" will always be 1 for such functions.

Message sent by: Controller
Answer: **MID 0222 Digital input function upload acknowledge**

For header description see section 2.2.2!

Table 208 MID 0221 Digital input no and status Revision 1

Parameter	Byte	Value
Digital input function no	21-22	01
	23-25	Three ASCII digits corresponding to a digital input function. See Table 203 and add 0 before the number in the list.
Digital input function status	26-27	02
	28	One ASCII digit representing the digital input function status: 1=active 0=not active.

5.18.14 MID 0222 Digital input function acknowledge

Acknowledgement of the digital input function upload.

Message sent by: Integrator

Answer: None

For header description see section 2.2.2!

5.18.15 MID 0223 Digital input function unsubscribe

Unsubscribe for a single digital input functions. The data field consists of three ASCII digits, the digital input function number. The digital input function numbers can be found in Table 203 above.

Message sent by: Integrator

Answer: **MID 0005 Command accepted** or
MID 0004 Command error, The digital input function subscription does not exist

For header description see section 2.2.2!

Table 209 MID 0223 Revision 1

Parameter	Byte	Value
Digital input function number	21-23	Three ASCII digits, see Table 203 and add 0 before the number in the list.

5.18.16 MID 0224 Set digital input function

Set the digital input function with the digital input number. The digital input function numbers are defined in Table 203.

Message sent by: Integrator
 Answer: MID 0005 Command accepted or
 MID 0004 Command error, Invalid data

For header description see section 2.2.2!

Table 210 MID 0224 Revision 1

Parameter	Byte	Value
Digital input function number	21-23	Three ASCII digits, see Table 203 and add 0 before the number in the list.

5.18.17 MID 0225 Reset digital input function

Reset the digital input function with the digital input number. The digital input function numbers are defined in Table 203.

This MID will only affect the digital input functions of tracking type. The digital input functions with the type flank cannot be reset (for example reset the reset batch digital input function will have no effect).

Message sent by: Integrator
 Answer: MID 0005 Command accepted or
 MID 0004 Command error, Invalid data

For header description see section 2.2.2!

Table 211 MID 0225 Revision 1

Parameter	Byte	Value
Digital input function number	21-23	Three ASCII digits, see Table 203. Put a 0 before the number in the list.

5.19 Application PLC user data messages

The automatic/manual mode messages are only available for PowerMACS. This section includes a description on how the PLC user data messages are defined.

Data sent or received with a message is defined as a string of ASCII HEX characters. A string could look like "11223344" where the first byte (counted from the start of the PLC area) shall be given the value 0x11 and the second 0x22 and so on. When declaring variables in the PLC that are of width larger than one byte they are stored in BIG ENDIAN ordering.

Example 1: In the PLC, variables for input and output are setup accordingly:

Table 212 Example 1 input

PLC Variable	Addr	Data Type
IN_1	%IB 13000	Byte
IN_2	%IW 13001-13002	16Bit Word (int)
IN_3	%ID 13003-13006	32Bit Word (dint)
IN_4	%IB 13007	Byte

Table 213 Example 1 output

PLC Variable	Addr	Data Type
OUT_1	%QB 13000	Byte
OUT_2	%QW 13001-13002	16Bit Word (int)
OUT_3	%QD 13003-13006	32Bit Word (dint)
OUT_4	%QB 13007	Byte

Both areas occupy 8 bytes each (1 + 2 + 4 + 1) and these bytes are assigned to the variables in the following way:

Input:

13000	13001	13002	13003	13004	13005	13006	13007
IN_1	IN_2	IN_2	IN_3	IN_3	IN_3	IN_3	IN_4
1:st byte in variable	1:st byte in variable	2:nd byte in variable	1:st byte in variable	2:nd byte in variable	3:d byte in variable	4:th byte in variable	1:st byte in variable

Output:

13000	13001	13002	13003	13004	13005	13006	13007
OUT_1	OUT_2	OUT_2	OUT_3	OUT_3	OUT_3	OUT_3	OUT_4
1:st byte in variable	1:st byte in variable	2:nd byte in variable	1:st byte in variable	2:nd byte in variable	3:d byte in variable	4:th byte in variable	1:st byte in variable

Example Cases:

The text within quotation marks denotes the data part of the telegram in ASCII HEX.

Case 1: Write to PLC with **MID 0240 User data download** message.

- Write variable IN_1 with the value 134 (0x86). All other variables zero. **"8600000000000000"**.

- Write variable IN_2 with the value 37567 (0x92bf). All other variables zero. “0092bf0000000000”.
- Write variable IN_3 with value 2000345 (0x1e85d9). All other variables zero. “000000001e85d900”.
- Write variable IN_3 with value 3000134000 (0xb2d26970). All other variables zero. “000000b2d2697000”.
- Write variable IN_4 with value 255 (0xff). All other variables zero. “00000000000000ff”.

Case 2: Read values of PLC variable from **MID 0240 User data** message.

The data “7834fece5678a2b7” is received.

- OUT_1 reads 120 (0x78)
- OUT_2 reads 13566 (0x34fe)
- OUT_3 reads 3461773474 (0xce5678a2)
- OUT_4 reads 183 (0xb7)

5.19.1 MID 0240 User data download

Used by the integrator to send user data input to the PLC.

Message sent by: Integrator
 Answer: MID 0005 Command accepted or
 MID 0004 Command error, Invalid data, or
 Controller is not a sync master/station controller

00280240	12345678NUL
----------	-------------

For header description see section 2.2.2!

Table 214 MID 0240 Revision 1

Parameter	Byte	Value
User data	21- max 220	Minimum 2 and maximum 200 ASCII characters.

5.19.2 MID 0241 User data subscribe

Subscribe for user data. This command will activate the **MID 0242 User data** message to be sent when a change in the user data output has been detected.

Message sent by: Integrator
Answer: **MID 0005 Command accepted** or
**MID 0004 Command error, Subscription already exists, or
Controller is not a sync master/station controller**

For header description see section 2.2.2!

5.19.3 MID 0242 User data

This message is sent by the controller to the integrator when a change has been detected in the user data.

Message sent by: Controller
Answer: **MID 0243 User data acknowledge**

For header description see section 2.2.2!

Table 215 MID 0242 Revision 1

Parameter	Byte	Value
User data	21- max 220	Minimum 2 and maximum 200 ASCII characters. See MID 0240 for a description.

5.19.4 MID 0243 User data acknowledge

Acknowledgement of user data.

Message sent by: Integrator
 Answer: None

For header description see section 2.2.2!

5.19.5 MID 0244 User data unsubscribe

Unsubscribe for the user data.

Message sent by: Integrator
 Answer: **MID 0005 Command accepted** or
MID 0004 Command error, Subscription already exists

For header description see section 2.2.2!

5.19.6 MID 0245 User data download with offset

Used by the integrator to send user data input to the PLC. The difference compared to MID 0240 User data download is that with this MID it is possible to specify an offset for the data written in the PLC. This makes it possible to have more than one device writing user data to the PLC on different data areas.

The available address range in the PLC is still 13 000 – 13 099, i.e. 100 bytes. The offset parameter in this MID specify the start address for the data in the PLC, i.e. the start address is 13 000 + Offset. Since the highest address is still 13 099 this means the number of data bytes to send will be limited by the offset. The maximum size of the user data will be (100 – offset) bytes, or 2 * (100 – offset) ASCII characters in the telegram.

Only data that is sent in the user data field will be written to the PLC, the remaining data will be untouched. This means for example that if the offset is 10 and the user data is 1234 the bytes with address 13010 and 13011 will be updated (to 0x12 and 0x34) and the rest of the area will be unchanged.

Message sent by: Integrator
 Answer: **MID 0005 Command accepted** or
MID 0004 Command error, Invalid data, or
Controller is not a sync master/station controller or
MID revision not supported.

00280245	12345678NUL
----------	-------------

For header description see section 2.2.2!

Table 216 MID 0245 User data download with offset, revision 1

Parameter	Byte	Value
Offset	21-23	Three ASCII digits Range 000-099 Specify the address offset in number of bytes for the user data in the PLC. The data is written to address 13000 + Offset in the PLC
User data	24-max 223	Minimum 2 and maximum 200 ASCII characters. See MID 0240 for a description. The maximum length for the field is $200 - 2 * \text{Offset}$

5.20 Application Selector messages

5.20.1 MID 0250 Selector socket info subscribe

Subscribe for the socket information of all socket selectors (connected to the controller). After subscription, every time a socket is lifted or put back, MID 0251 is sent to the subscriber with the device ID of the selector and the current status of each one of the sockets, lifted or not.

Message sent by: Integrator
 Answer: **MID 0005 Command accepted** or
MID 0004 Command error, The selector socket info subscription already exists

For header description see section 2.2.2!

5.20.2 MID 0251 Selector socket info

This message is sent each time a socket is lifted or put back in position. This MID contains the device ID of the selector the information is coming from, the number of sockets of the selector device, and the current status of each socket (lifted or not lifted).

Message sent by: Controller
 Answer: **MID 0252, Selector socket info acknowledge**

For header description see section 2.2.2!

Table 217 MID 0251 Selector socket data Revision 1

Parameter	Byte	Value
Device ID	21-22	01
	23-24	Two ASCII digits corresponding to the selector device ID. Range 00-99
Number of sockets	25-26	02
	27-28	Two ASCII digits representing the selector's number of sockets. Range 00-99
Socket status	29-30	03
	31- (+1× Number of sockets)	0=socket not lifted 1=socket lifted

5.20.3 MID 0252 Selector socket info acknowledge

Acknowledgement of the **MID 0251 Selector socket info**.

Message sent by: Integrator

Answer: None

For header description see section 2.2.2!

5.20.4 MID 0253 Selector socket info unsubscribe

Unsubscribe for the selector socket info. The subscription is reset for all selector devices.

Message sent by: Integrator

Answer: **MID 0005 Command accepted** or
MID 0004 Command error, The selector socket info subscription does not exist

For header description see section 2.2.2!

5.20.5 MID 0254 Selector control green lights

This message controls the selector green lights. The green light can be set (steady), reset (off) or flash. A command must be sent for each one of the selector positions.

Note: This MID only works when the selector is put in external controlled mode and this is only possible when the selector is loaded with software 1.20 or later.

Message sent by: Integrator

Answer: **MID 0005 Command accepted** or
MID 0004 Command error, Faulty IO device ID

For header description see section 2.2.2!

Table 218 MID 0254 Selector green lights revision 0, 1

Parameter	Byte	Value
Device ID	21-22	01
	23-24	Two ASCII digits corresponding to the selector device ID. Range 00-99
Green light Command selector position 1-8	25-26	02
	27-34	For each green light, selector position 1-8. 0=Off, 1=steady, 2=flashing

Table 219 MID 0254 Selector green lights revision 2

Parameter	Byte	Value
Device ID	21-22	01
	23-24	Two ASCII digits corresponding to the selector device ID. Range 00-99
Number of sockets	25-26	02
	27-28	Two ASCII digits corresponding to the number of sockets
Green light Command	29-30	03
	31- (+1× Number of sockets)	For each green light, 0=Off, 1=steady, 2=flashing

5.20.6 MID 0255 Selector control red lights

This message controls the selector red lights. The red light can be set (steady), reset (off) or flash. A command must be sent for each one of the selector positions.

Note: This MID only works when the selector is put in external controlled mode and this is only possible when the selector is loaded with software 1.20 or later.

Message sent by: Integrator
 Answer: **MID 0005 Command accepted** or
MID 0004 Command error, Faulty IO device ID

For header description see section 2.2.2!

Table 220 MID 0255 Selector red lights revision 0, 1

Parameter	Byte	Value
Device ID	21-22	01
	23-24	Two ASCII digits corresponding to the selector device ID. Range 00-99
Red light Command selector position 1-8	25-26	02
	27-34	For each red light, selector position 1-8. 0=Off, 1=steady, 2=flashing

Table 221 MID 0255 Selector red lights revision 2

Parameter	Byte	Value
Device ID	21-22	01
	23-24	Two ASCII digits corresponding to the selector device ID. Range 00-99
Number of sockets	25-26	02
	27-28	Two ASCII digits corresponding to the number of sockets
Red light Command	29-30	03
	31- (+1× Number of sockets)	For each red light, 0=Off, 1=steady, 2=flashing

5.20.7 MID 1900 Selector socket info

This message is sent each time a socket is lifted or put back in position. This MID contains the device ID of the selector the information is coming from, the number of sockets of the selector device, and the current status of each socket (lifted or not lifted). The MID uses the variable parameter pattern.

[Variable Data Field Use](#)

Message sent by: Controller

Answer: MID 0005 with MID 1900 in the data field.

If the sequence number acknowledge functionality is used there is no need for this acknowledge type

From byte 21 the data field is used as follows.

Parameter	Size	Data type	Description		
Number of data fields	3	UI	The number of variable data fields in the telegram. If no data fields exist "000" will be sent. Must be the first of each section of variable data fields.		
Data fields	Vary	This section is repeated Number of data fields times. If Number of data fields = 000, this section is not sent.			
		Parameter	Size [byte]	Data type	Description
		Parameter id (PID).	5	UI	The available PID's may vary depending on the system type = Device ID PID.
		Length	3	UI	Length of data value.
		Data Type	2	UI	Data type of the data value. UI = Unsigned integer
		Unit	3	UI	Unit of the data. No unit

			Step no.	4	UI	The step number for the result variable. Sent as 0000 if not relevant. 0000
			Data value	Length		The data value. Device ID
			Parameter id (PID).	5	UI	The available PID's may vary depending on the system type = Socket status PID.
			Length	3	UI	Length of data value. = Number of sockets according to Data Type
			Data Type	2	UI	Data type of the data value. . = UA = Array of unsigned integers
			Unit	3	UI	Unit of the data. No unit
			Step no.	4	UI	The step number for the result variable. Sent as 0000 if not relevant. 0000
			Data value	Length		The data value 0=socket not lifted 1=socket lifted.

5.20.7.1 MID 1900 subscription and stop subscription

Use generic MID 0008 to start subscription. Use MID 0009 to stop subscription. No extra data field is necessary

5.20.8 MID 1901 Selector socket control

This message controls the selector lights color. The light can be set (steady), reset (off) or flash. A command will influence all selector positions. The MID uses the variable parameter pattern. [Variable Data Field Use](#)

Note: This MID only works when the selector is put in external controlled mode and this is only possible when the selector is loaded with software 1.20 or later.

Message sent by: Integrator

Answer: MID 0005 Command accepted or

MID 0004 Command error, Faulty IO device ID

From byte 21 the data field is used as follows.

Parameter	Size	Data type	Description																																												
Number of data fields	3	UI	The number of variable data fields in the telegram. If no data fields exist "000" will be sent. Must be the first of each section of variable data fields.																																												
Data fields	Vary		This section is repeated Number of data fields times. If Number of data fields = 000, this section is not sent.																																												
			<table border="1"> <thead> <tr> <th>Parameter</th> <th>Size [byte]</th> <th>Data type</th> <th>Description</th> </tr> </thead> <tbody> <tr> <td>Parameter id (PID).</td> <td>5</td> <td>UI</td> <td>The available PID's may vary depending on the system type = Device ID PID.</td> </tr> <tr> <td>Length</td> <td>3</td> <td>UI</td> <td>Length of data value.</td> </tr> <tr> <td>Data Type</td> <td>2</td> <td>UI</td> <td>Data type of the data value. UI = Unsigned integer</td> </tr> <tr> <td>Unit</td> <td>3</td> <td>UI</td> <td>Unit of the data. No unit</td> </tr> <tr> <td>Step no.</td> <td>4</td> <td>UI</td> <td>The step number for the result variable. Sent as 0000 if not relevant. 0000</td> </tr> <tr> <td>Data value</td> <td>Length</td> <td></td> <td>The data value. Device ID</td> </tr> <tr> <td>Parameter id (PID).</td> <td>5</td> <td>UI</td> <td>The available PID's may vary depending on the system type = Socket color PID.</td> </tr> <tr> <td>Length</td> <td>3</td> <td>UI</td> <td>Length of data value. = Number of sockets according to Data Type</td> </tr> <tr> <td>Data Type</td> <td>2</td> <td>UI</td> <td>Data type of the data value. . = UA = Array of unsigned integers</td> </tr> <tr> <td>Unit</td> <td>3</td> <td>UI</td> <td>Unit of the data. No unit</td> </tr> </tbody> </table>	Parameter	Size [byte]	Data type	Description	Parameter id (PID).	5	UI	The available PID's may vary depending on the system type = Device ID PID.	Length	3	UI	Length of data value.	Data Type	2	UI	Data type of the data value. UI = Unsigned integer	Unit	3	UI	Unit of the data. No unit	Step no.	4	UI	The step number for the result variable. Sent as 0000 if not relevant. 0000	Data value	Length		The data value. Device ID	Parameter id (PID).	5	UI	The available PID's may vary depending on the system type = Socket color PID.	Length	3	UI	Length of data value. = Number of sockets according to Data Type	Data Type	2	UI	Data type of the data value. . = UA = Array of unsigned integers	Unit	3	UI	Unit of the data. No unit
Parameter	Size [byte]	Data type	Description																																												
Parameter id (PID).	5	UI	The available PID's may vary depending on the system type = Device ID PID.																																												
Length	3	UI	Length of data value.																																												
Data Type	2	UI	Data type of the data value. UI = Unsigned integer																																												
Unit	3	UI	Unit of the data. No unit																																												
Step no.	4	UI	The step number for the result variable. Sent as 0000 if not relevant. 0000																																												
Data value	Length		The data value. Device ID																																												
Parameter id (PID).	5	UI	The available PID's may vary depending on the system type = Socket color PID.																																												
Length	3	UI	Length of data value. = Number of sockets according to Data Type																																												
Data Type	2	UI	Data type of the data value. . = UA = Array of unsigned integers																																												
Unit	3	UI	Unit of the data. No unit																																												

			Step no.	4	UI	The step number for the result variable. Sent as 0000 if not relevant. 0000
			Data value	Length		The data value. 0,1 = Green, Read etc.
			Parameter id (PID).	5	UI	The available PID's may vary depending on the system type = Socket status PID.
			Length	3	UI	Length of data value. = Number of sockets according to Data Type
			Data Type	2	UI	Data type of the data value. = UA = Array of unsigned integers
			Unit	3	UI	Unit of the data. No unit
			Step no.	4	UI	The step number for the result variable. Sent as 0000 if not relevant. 0000
			Data value	Length		The data value. 0,1,2 = Off, Steady ,Flash

5.21 Application Tool Location System messages

This message group is only applicable if using the Tool Location System (TLS) system.

5.21.1 MID 0260 Tool tag ID request

Used by the integrator to request Tool tag ID information.

Message sent by: Integrator
 Answer: **MID 0262 Tool tag ID** or
MID 0004 Command error, Tool tag ID unknown or MID revision unsupported.

For header description see section 2.2.2!

5.21.2 MID 0261 Tool tag ID subscribe

Used by the integrator to order a Tool tag ID subscription from the controller.

Message sent by: Integrator
 Answer: **MID 0005 Command accepted** or
MID 0004 Command error,
Tool tag ID unknown , Tool tag ID subscription already exist or
MID revision unsupported.

For header description see section 2.2.2!

5.21.3 MID 0262 Tool tag ID

Used by the controller to send a Tool tag ID to the integrator.

Message sent by: Controller
 Answer: **MID 0263 Tool tag ID acknowledge**
None

For header description see section 2.2.2!

Table 222 MID 0262 TLS ST Tool Tag Identity Revision 1

Parameter	Byte	Value
Tool tag ID	21-22	01
	23-30	Tool tag ID. The ID value has a hexadecimal representation which should be interpreted as in the following example. Example 3200078D -> 50-0-7-141

5.21.4 MID 0263 Tool tag ID acknowledge

Acknowledgement of **MID 0262 Tool tag ID**.

Message sent by: Integrator

Answer: **None**

For header description see section 2.2.2!

5.21.5 MID 0264 Tool tag ID unsubscribe

Used by the integrator to send a Tool tag ID unsubscription to the controller.

Message sent by: Integrator

Answer: **MID 0005 Command accepted or
MID 0004 Command error,
Tool tag ID subscription does not exist or
MID revision unsupported.**

For header description see section 2.2.2!

5.21.6 MID 0265 External Tool tag ID and status

Used by the controller to detect a Tool tag ID with its status from the integrator.

Message sent by: Integrator
Answer: **MID 0005 Command accepted** or
MID 0004 Command error,
MID revision unsupported.

For header description see section 2.2.2!

Table 223 MID 0265 External TLS Tool Tag Identity and status Revision 1

Parameter	Byte	Value
Tool tag ID	21-22	01
	23-30	Tool tag ID Belonging to this controller. The ID value has a hexadecimal representation which should be interpreted as in the following example. Example 3200078D -> 50-0-7-141.
Status	31-32	02
	33-34	01 = Operable, 02 = Inoperable

5.22 Application Controller messages

5.22.1 MID 0270 Controller reboot request

This message causes the controller to reboot after it has accepted the command.

Warning 1: this MID requires **programming control** (see 4.4 Programming control).

Warning 2: the connection will be lost and will need to be reestablished after controller reboot!

Message sent by: Integrator

Answer: **MID 0005 Command accepted** or
MID 0004 Command error, Programming control not granted

Example: Request for controller reboot.

00200270	NUL
----------	-----

For header description see section 2.2.2!

5.22.2 MID 2100 Device command.

Message sent by: Integrator
Answer: MID 0005 Command accepted or
MID 0004 Command error, un-known command

This message include the possibility to send commands to the device, for example to make the device to reboot or enter sleep mode. There are generic commands for al type of devices, but then there are a range of commands specific to the device in question, these are specified in the appendix for each device!

For each command it is also possible to send extra data, if so this is specified for that command.

Warning 1: this MID requires **programming control** (see 4.4 Programming control).

For header description see section 2.2.2!

Table 224 Definition of required and optional parameters of MID 2100

Parameter	Size [byte]	Data type	Description
Command ID	4	UI	Four ASCII digits, range 0000-9999. Available command can be found in Table 225 and each device appendix.
Number of parameter data fields	3	UI	The number of variable data fields. Number of parameters for the selected command. Available extra data can be found in the command specification list.
Data fields	Vary		This section is repeated “Number of data fields” times. If Number of data fields = 000, this section is not sent. The structure is of variable parameter type, see Variable Data Field Use

Table 225 Available Generic Commands

Command	ID	Description	Extra data to be sent
Device Reboot	0001	Request the device to reboot. Please observe that the connection need to be re-established after the reboot!	N/A
Device enter standby	0002	Request the device to enter standby mode after it has accepted the command. The exact nature of the standby mode is platform dependent but is generally understood to mean some kind of power saving mode.	N/A
Device leave standby	0003	Request the device the leave standby mode after it has accepted the command. The exact nature of the standby mode is platform dependent but is generally understood to mean some kind of power saving mode.	N/A
<i>Reserved range for Atlas Copco Power Focus 6000</i>	1000-1500	This range is reserved for Atlas Copco Power Focus 6000 device. Please see the appendix for Power Focus 6000 for information	See appendix for Power Focus 6000 for information.
<i>Reserved range for Desoutter</i>	1501-2000	This range is reserved for Desoutter. Please check the respective appendix for more information	See appendix for Desoutter for information

A check for allowed PIDs to be included in this message should be done for each device type.

5.23 Statistic messages

5.23.1 MID 0300 Histogram upload request

Request to upload a histogram from the controller for a certain parameter set.

The histogram is calculated with all the tightening results currently present in the controller's memory and within the statistic acceptance window (statistic min and max limits) for the requested parameter set.

Message sent by: Integrator
Answer: **MID 0301, Histogram upload reply, or
MID 0004 Command error, No histogram available or
Invalid data**

Example: Upload torque histogram for parameter set 1.

002903000000	010010200NUL
--------------	--------------

For header description see section 2.2.2!

Table 226 MID 0300 Parameter set and histogram type Revision 1

Parameter	Byte	Value
Parameter set ID	21-22	01
	23-25	The parameter set ID of the requested histogram. Three ASCII digits. Range 000-999
Histogram type	26-27	02
	28-29	Histogram type is two bytes long and is specified by two ASCII digits. 00=Torque 01=Angle 02=Current 03=Prevail torque 04=Self Tap 05=Rundown angle

5.23.2 MID 0301 Histogram upload reply

Histogram upload reply for the requested parameter set and for the requested histogram type. The histogram uploaded is made of 9 bars according to Figure 24 Histogram example.

Message sent by: Controller

Answer:

None

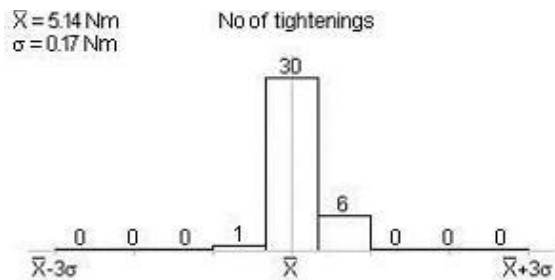

Figure 24 Histogram example

For header description see section 2.2.2!

Table 227 MID 0301 Histogram data Revision 1

Parameter	Byte	Value
Parameter set ID	21-22	01
	23-25	The parameter set ID of the requested histogram. Three ASCII digits. Range 000-999
Histogram type	26-27	02
	28-29	Histogram type is two bytes long and is specified by two ASCII digits. 00=Torque 01=Angle 02=Current 03=Prevail torque 04=Self Tap 05=Rundown angle
Sigma histogram	30-31	03
	32-37	Sigma for all the tightening results (within the statistic acceptance window) currently present in the memory for the parameter set requested. Sigma is multiplied by 100 and sent as an integer (2 decimals truncated). Sigma is six bytes long and is specified by six ASCII digits. Range 000000-999999.
Mean value histogram (X-bar)	38-39	04
	40-45	The mean value for all the tightening results (within the statistic acceptance window) currently present in the memory for the parameter set requested. The mean value is multiplied by 100 and sent as an integer (2 decimals truncated). Mean value is six bytes long and is specified by six ASCII digits. Range 000000-999999.
Class range	46-47	05
	48-53	The class range is equal to 6 sigma / 9. The class range is multiplied by 100 and sent as an integer (2 decimals truncated). Mean value is six bytes long and is specified by six ASCII digits. Range 000000-999999.
Bar 1	54-55	06
	56-59	Number of tightening in bar 1, four bytes long and specified as four ASCII digits. Range 0000-9999.

All messages

Parameter	Byte	Value
Bar 2	60-61	07
	62-65	Number of tightening in bar 2, four bytes long and specified as four ASCII digits. Range 0000-9999.
	66-67	08
Bar 3	68-71	Number of tightening in bar 3, four bytes long and specified as four ASCII digits. Range 0000-9999.
	72-73	09
Bar 4	74-77	Number of tightening in bar 4, four bytes long and specified as four ASCII digits. Range 0000-9999.
	78-79	10
Bar 5	80-83	Number of tightening in bar 5, four bytes long and specified as four ASCII digits. Range 0000-9999.
	84-85	11
Bar 6	86-89	Number of tightening in bar 6, four bytes long and specified as four ASCII digits. Range 0000-9999.
	90-91	12
Bar 7	92-95	Number of tightening in bar 7, four bytes long and specified as four ASCII digits. Range 0000-9999.
	96-97	13
Bar 8	98-101	Number of tightening in bar 8, four bytes long and specified as four ASCII digits. Range 0000-9999.
	102-103	14
Bar 9	104-107	Number of tightening in bar 9, four bytes long and specified as four ASCII digits. Range 0000-9999.

5.24 Application Automatic/Manual mode messages

The automatic/manual mode messages are only available for PowerMACS while automatic disable settings request (MID 410) and reply (MID 411) messages exists both in Power Macs and the Power Focus controllers.

5.24.1 MID 0400 Automatic/Manual mode subscribe

A subscription for Automatic/Manual mode. When the mode changes the **MID 0401 Automatic/Manual mode upload** is sent to the integrator.

After a successful subscription the message **MID 0401 Automatic/Manual mode upload** with the current mode status is sent to the integrator.

Message sent by: Integrator
 Answer: **MID 0005 Command accepted** or
MID 0004 Command error, Automatic/Manual mode subscribe already exists

For header description see section 2.2.2!

5.24.2 MID 0401 Automatic/Manual mode

The operation mode in the controller has changed. The message includes the new operational mode of the controller.

Message sent by: Controller
 Answer: **MID 0402 Automatic/Manual mode acknowledge**

For header description see section 2.2.2!

Table 228 MID 0401 Revision 1

Parameter	Byte	Value
Manual/Automatic mode	21	One ASCII digit. 0=Automatic mode, 1=Manual mode

5.24.3 MID 0402 Automatic/Manual mode acknowledge

Acknowledgement of automatic/manual mode upload.

Message sent by: Integrator
 Answer: None

For header description see section 2.2.2!

5.24.4 MID 0403 Automatic/Manual mode unsubscribe

Reset the subscription for the automatic/manual mode.

Message sent by: Integrator
Answer: MID 0005 Command accepted or
MID 0004 Command error, Automatic/Manual mode subscribe does not exist

For header description see section 2.2.2!

5.24.5 MID 0410 AutoDisable settings request

Request for AutoDisable settings. This request is intended to be used while running single parameter sets with batch and does not provide batch information while running Job.

Message sent by: Integrator
Answer: MID 0411 AutoDisable settings reply

For header description see section 2.2.2!

5.24.6 MID 0411 AutoDisable settings reply

Information about the setting of AutoDisable tightening in the controller. Also contains information about the currently running batch.

The settings are reserved for single parameter sets with batch and are not available while running Job.

Power Macs use:

“Oks to disable station” is a parameter in Tools Talk PowerMACS and specifies the number of cycles with status OK or OKR that may be run while in Automatic mode before the station is automatically disabled. It is sent as two ASCII digits, a 0 means the function is not in use.

“Current Batch” is two ASCII digits representing the number of OK cycles that have been run in the current batch. If the value is 0 no batch is running at the moment.

Power Focus use:

The “Current Batch” contains at which batch counter value/tightening the parameter set batch was locked/finished if “batch count” and “lock at batch ok” parameters in Tools Talk PF was used, otherwise it will contain 0 indicating function not used. If “lock at batch ok” parameter was not used the “Current Batch” is just current.

The “Auto Disable” contains the parameter sets batch size if “batch count” and “lock at batch ok” parameters was used indicating that Auto Disable function is used. If “batch count” or “lock at batch ok” was not used the “Auto Disable” is 0.

Message sent by: Controller

Answer: None

For header description see section 2.2.2!

Table 229 MID 0411 Revision 1

Parameter	Byte	Value
Auto Disable setting	21-22	Two ASCII digits. 00= not used, <> 00=in use
Current batch	23-24	Two ASCII digits. Range 00-99. 00=function not used

5.25 Application Open Protocol Commands Disabled

When the **Open Protocol commands disable** digital input is active, the commands marked in column Open protocol commands in Table 7 Available messages will be rejected and the message **MID 0004 Command error, Open Protocol commands disabled** (Error 92) will be sent.

5.25.1 MID 0420 Open Protocol commands disabled subscribe

Set the subscription for the **Open Protocol commands disable** digital input. This command will result in transmission of the Open Protocol commands disable input status. When a subscription is set the **Open Protocol commands disable** digital input status is once uploaded (MID 0421) automatically. Thereafter, the status is uploaded each time the digital input status changes (push function).

Message sent by: Integrator
Answer: **MID 0005 Command accepted** or
MID 0004 Command error, Open Protocol commands disabled
subscription already exists

For header description see section 2.2.2!

5.25.2 MID 0421 Open Protocol commands disabled

Upload the status of the **Open Protocol commands disable** digital input. The data upload consists of one byte delivering the digital input status. The status is uploaded each time the “Open Protocol commands disable” digital input changes (push function).

Message sent by: Controller
Answer: **MID 0422 Open Protocol commands disabled acknowledge**

For header description see section 2.2.2!

Table 230 MID 0421 Revision 1

Parameter	Byte	Value
Digital input status	21	1=true, 0=false

5.25.3 MID 0422 Open Protocol commands disabled acknowledge

Acknowledgement of Open Protocol commands disabled upload.

Message sent by: Integrator
Answer: None

For header description see section 2.2.2!

5.25.4 MID 0423 Open Protocol commands disabled unsubscribe

Reset the subscription for the **Open Protocol commands disabled** digital input.

Message sent by: Integrator
Answer: **MID 0005 Command accepted** or
MID 0004 Command error, Open Protocol commands disabled subscription does not exist

For header description see section 2.2.2!

5.26 Application MID 8000 to MID 8100 and MID 9000 to 9100

Reserved for customer use, see customer Appendix.

5.27 Application Motor tuning

Subscriptions and commands for the area of motor tuning

5.27.1 MID 0500 Motor tuning result data subscribe

Sets the subscription for the motor tuning result. The result of this command will be the transmission of the motor tuning result after the motor tuning is performed. The MID revision in the header is used to subscribe to different revisions of **MID 0501 Motor tuning result data upload reply**.

Message sent by: Integrator

Answer: **MID 0004 Command error, Motor Tuning subscription already exists or MID revision not supported**

For header description see section 2.2.2!

5.27.2 MID 0501 Motor tuning result data

Upload the last motor tuning result.

Message sent by: Controller

Answer: **MID 0502 Motor tuning result data acknowledge**

For header description see section 2.2.2!

Table 231 MID 501Motor tuning result data Revision 1

Parameter	Byte	Value
Motor Tune result	21-22	01
	23	The Motor tune status, one ASCII digit : 0 (Motor tune failed) or 1 (Motor tune success)

5.27.3 MID 0502 Motor tuning result data acknowledge

Acknowledgement of motor tuning result data.

Message sent by: Integrator

Answer: None

For header description see section 2.2.2!

5.27.4 MID 0503 Motor tuning result data unsubscribe

Reset the motor tuning result subscription.

Message sent by: Integrator

Answer: MID 0005 Command accepted or MID 0004 Command error, **Motor Tuning result subscription** does not exist

For header description see section 2.2.2!

5.27.5 MID 0504 Motor tuning request

Request the start of the motor tuning.

Warning !: This command must be implemented during hard restrictions and customer dependent requirements.

Message sent by: Integrator

Answer: **MID 0005 Command accepted** or
MID 0004 Command error, Tool motor tuning failed

For header description see section 2.2.2!

5.28 Application Keep alive message

5.28.1 MID 9999 Keep alive message

The integrator sends a keep alive to the controller. The controller should only mirror and return the received keep alive to the integrator.

The controller has a communication timeout equal to 15s. This means that if no message has been exchanged between the integrator and the controller for the last 15s, then the controller considers the connection lost and closes it.

In order to keep the communication alive the integrator must send a keep alive to the controller with a time interval lower than 15s.

In products, the communication timeout value cannot be set less than 15s and if timeout value more than 15s is required by products then the timeout value shall be updated on the respective product appendix, an important note here is that the controller time and integrator time has to be relative when mentioning the timeout value in the product appendix.

Note: An inactivity timeout is suggested to integrator i.e. if no message has been exchanged (sent or received) during the last 10s, send a keep alive.

Message sent by: Integrator

Answer: The same message mirrored by the controller.

For header description see section 2.2.2!

6 Unit /Parameter ID/Data Type definitions

In this chapter are valid unit types, parameter ID numbers and Data Types defined for the variable data field pattern structure.

These lists will be typically updated over time, when new unit's types and parameter IDs are wanted to be added.

6.1 Data Type definitions

Below is shown the Data Type definitions which has the Format: Max 2 ASCII characters

Format: 2 ASCII characters

Table 232 Data type definitions

Value sent in telegram	Type	Length	Description
01	UI	Variable	The value is an unsigned integer. The number of digits are defined with the Length parameter
02	I	Variable	The value is a signed integer. The number of digits are defined with the Length parameter
03	F	Variable	The value is sent as a float value with the layout "12.12", "10025.1234" or "-57.5" etc. It is up to the sender of the telegram to decide the number of decimals to send. The number of characters sent varies depending on the size and resolution of the sent number.
04	S	Variable	The value is a string. Sent as ASCII characters, the length of the data fits the actual length of the string. Note that the string may contain spaces (ASCII character 0x20)
05	T	19	A time specified by 19 ASCII characters (YYYY-MM-DD:HH:MM:SS)
06	B	1	A boolean value, one ASCII digit, 0 = FALSE and 1 = TRUE
07	H	Variable	Hexadecimal value. Sent as ASCII characters, example "A24CD3".
08	PL1	Variable	Plotting point consisting of a FA of one pair of float values where the first value is the Y and the second is the X within the pair.
09	PL2	Variable	Plotting point consisting of a FA of two pairs of float values where the first value is the Y and the second is the X within a pair.
10	PL4	Variable	Plotting point consisting of a FA of 4 pairs of float values where the first value is the Y and the second is the X within a pair.
50	FA	Variable	Array of Float. Each float value is sent as 8 ASCII characters. Negative values start with a '-' sign. The precision of the values vary, for large values decimal point is omitted. Valid values are for example "-1234567", "001.1205", "-123.789"
51	UA	Variable	Array of Unsigned integers. Each integer value is sent as 8 ASCII characters Valid values are for example "12345678", "00001234", "00200000"

52	IA	Variable	Array of Signed integers. Each integer value is sent as 8 ASCII characters. Negative values start with a '-' sign. Valid values are for example "12345678", "-1234567", "00200000", "10200000"
----	----	----------	--

6.2 Trace Plotting type figures definitions

The following plotting figure types are defined.

LINE, high or low. When using data type of ether FA

POINT, single point. When using data type PL1

WINDOW, 4 plot points with lines drawn between and filled. When using data type PL4

DOUBLE ARROW LINE, 2 plot points with double arrow line between. When using data type PL2

6.3 Unit types definitions

Below is shown the Data Type definitions which has the Format: 3 ASCII characters

Table 233 Unit type definitions

Value sent in telegram	Unit	
000	No unit	
<i>Torque units</i>		
001	N·m	(Newton meter)
002	ft lbf	(foot-pound force)
003	cN·m	(centi Newton meter)
004	kN·m	(kilo Newton meter)
005	MN·m	(Mega Newton meter)
006	in lbf	(inch-pound force)
007	Kpm	(kilo pound meter)
008	Kfcnm	(Kilo centi force) -OBSOLETE
009	%	-OBSOLETE
010	Ozf-in	
011	dNm	
012	mNm	(milli-newton meter)
013	kgf.cm	(Kilogram force centimeter)
014	gf.cm	(gram force centimeter)
015	ft-ozf	(ounce force foot)

Angle units		
050	°	(Degree)
051	rad	(radian)
Frequency units		
100	Hz	(hertz)
101	rpm	(revolutions per minute)
Torque rate units		
150	N·m / °	(Newton meter / degree)
151	ft lbf / °	(foot-pound force / degree)
152	cN·m / °	(centi Newton meter / degree)
153	kN·m / °	(kilo Newton meter / degree)
154	MN·m / °	(mega Newton meter / degree)
155	in lbf / °	(inch-pound force / degree)
160	N·m / rad	(Newton meter / rad)
161	ft lbf / rad	(foot-pound force / rad)
162	cN·m / rad	(centi Newton meter / rad)
Time units		
200	s	(second)
201	min	(minute)
202	ms	(milliseconds)
203	h	(hour)
Temperature units		
250	K	(kelvin)
251	°C	(degree Celsius)
252	°F	(degree Fahrenheit)
Force units		
300	N	(newton)
301	kN	(kilo newton)
302	lbf	(pound-force)
303	kgf	(kilogram-force)
304	ozf	(ounce-force)
305	MN	(mega newton)
Length units		
350	m	(meter)
351	mm	(millimeter)
352	in	(inch)

Unit /Parameter ID/Data Type definitions

Speed units		
400	m/s	(meter per second)
401	mm/s	(millimeter per second)
Force rate units		
450	N / mm	(newton / millimeter)
451	kN / mm	(kilo newton / millimeter)
452	lbf / in	(pound-force / inch)
453	Kgf / mm	(kilogram-force / millimeter)
454	Ozf / in	(ounce-force / inch)
455	MN / mm	(mega newton / millimeter)
Acceleration units		
500	m/s ²	(meter per second squared)
501	mm/s ²	(millimeter per second squared)
Mass units		
550	kg	(kilogram)
551	lb	(pound)
Volume units		
600	L	(liter)
601	m ³	(cubic meter)
Area units		
650	m ²	(square meter)
Power units		
700	W	(Watt)
Electric units		
750	A	(Ampere)
751	V	(Volt)
752	Ω	(ohm)
753	F	(farad)
754	H	(henry)
Other units		
800	%	(percentage)
Pressure units		
850	kPa	(kilo pascal)

<i>Plotting units</i>	
900	N·m / ms (Y = Newton meter, X = milliseconds)
901	ft lbf / ms (Y = foot-pound force, X = milliseconds)
902	cN·m / ms (Y = centi Newton meter, X = milliseconds)
903	kN·m / ms (Y = kilo Newton meter, X = milliseconds)
904	MN·m / ms (Y = mega Newton meter, X = milliseconds)
905	in lbf / ms (Y = inch-pound force, X = milliseconds)
910	° / ms (Y = Degree, X = milliseconds)
911	rad / ms (Y = Radian, X = milliseconds)
920	N / ms (Y = newton, X = milliseconds)
921	kN / ms (Y = kilo newton, X = milliseconds)
922	Lbf / ms (Y = pound-force, X = milliseconds)
923	kgf / ms (Y = kilogram-force, X = milliseconds)
924	ozf / ms (Y = ounce-force, X = milliseconds)
925	MN / ms (Y = mega newton, X = milliseconds)

6.4 Parameter ID numbers

Below is shown parameter IDs that are common for all systems using open protocol.

Format: 5 ASCII digits

Table 234 Parameter IDs definitions common

Parameter id (PID)	Name	Description
<i>Statuses</i>		
00001	Tightening Status	The overall status of all the tools in the tightening. 0=NOK 1=OK
00002	Station ID	The station id is a unique id for each station. In ASCII figures 0-9
00003	Station Name	The station name. In ASCII characters.

Unit /Parameter ID/Data Type definitions

Parameter id (PID)	Name	Description
00005	Overall Tightening Status Additional Information	Additional information related to the Tightening Status Possible values are: 1 = Repaired 2 = Stopped 3 = Emergency Stopped 4 = Tool Error 5 = Drive Error 6 = Invalid Tightening Program 7 = PreStart Check Failed
Identifiers		
00010	VIN Number	The VIN number for the tightening
00011	Identifier 1	Identifier 1 used for the tightening. Could for example be a pallet number, identity of the operator, identification for the part, etc...
00012	Identifier 2	...
00013	Identifier 3	...
00014	Identifier 4	...
00015	Identifier 5	...
00016	Identifier 6	...
00017	Identifier 7	...
00018	Identifier 8	...
00019	Identifier 9	...
00020	Identifier 10	Identifier 10 used for the tightening. Could for example be a pallet number, identity of the operator, identification for the part, etc...
00030	Tightening Identifier	Identifier for tightening 10 figures long.
00031	Identifier handling	Types of handling can be: 1 = Reset the latest identifier 2 = Reset all identifiers 3 = Bypass to next identifier in a list of identifiers to be used for next tightening
00041	Selected Identifier Number	The identifier number to be used to select the program
00050	Oldest result Id	Oldest result Id in a controller result database. 32 bit
00051	Latest result Id	Latest result Id in a controller result database. 32 bit
00052	Oldest result Time	Oldest result Time in a controller result database. Unix time
00053	Latest result Time	Latest result Time in a controller result database. Unix time
Event parameter		
00040	Events	System common. But content unique for each system.
Batch parameters		
00100	Batch size	This parameter gives the total number of tightenings in the batch. Only used if this tightening was a part of a batch.

Parameter id (PID)	Name	Description
00101	Batch counter	The number for this tightening in the batch. Only used if this tightening was a part of a batch.
00102	Batch complete status	The current status of the batch. Only used if this tightening was a part of a batch. 0=Batch not completed 1=Batch completed 2=No batch
00103	Batch count	0 = Off, 1 = Pset, 2 = Fieldbus, 3 = Ethernet/Serial
00104	Batch increment when NOK	0 = No, 1= Yes
00105	Batch Status	The current status of the batch. Only used if this tightening was a part of a batch. 0=batch NOK, 1=batch OK, 2=batch not used, 3=batch running
<i>Tightening program information</i>		
01000	Tightening program Number	The number or index of the tightening program or Pset that made the tightening
01001	Tightening program Name	The name of the tightening program or Pset that made the tightening

Parameter id (PID)	Name	Description
01002	Control Tightening program Strategy	The overall strategy used in the tightening program. Possible strategies are: 01=Torque control 02=Torque control / angle monitoring 03=Torque control / angle control AND 04=Angle control / torque monitoring 05=DS control 06=DS control torque monitoring 07=Reverse angle 08=Reverse torque 09=Click wrench 10=Rotate spindle forward 11=Torque control angle control OR 12=Rotate spindle reverse 13=Home position forward 14=EP Monitoring 15=Yield 16=EP Fixed 17=EP Control 18=EP Angle shutoff 19=Yield / torque control OR 20=Snug gradient 21=Residual torque / Time 22=Residual torque / Angle 23=Breakaway peak 24=Loose and tightening 25=Home position reverse 26=PVT comp with Snug 27 =Batch 28 = PVT Monitoring 29 = PVT Compensate 30 = Self-tap 31 = Rundown 32 = CM 33 = Four Stage tightening torque 34 = Four Stage tightening angle 35 = STW Loosening 36 = External result text
01003	Time of last change in tightening program settings	Date and time of last change in tightening program settings
01004	Number of steps	The number of steps in the tightening program
01005	Tightening Strategy	One stage = 0, Two stage = 1, Quick step = 2, Ergo ramp = 3
01006	Trace Tool Start	Start trace from Start = 0 or Cycle Start = 1
01007	Cycle Tool Start	Torque value from where the tightening cycle is considered as started.
01008	Remove fastener limit	Torque value for the limit at which the fastener shall be removed.
01009	Measure Torque at	Torque result measured at Torque peak = 0, Angle peak = 1 or Shut off angle = 2
01010	Monitor Angle High limit	High limit for monitor Angle High Limit

Parameter id (PID)	Name	Description
01011	Measure Angle to	Torque peak = 0, Angle peak = 1, Cycle complete = 2, Shut off = 3 or Not used = 4
01012	Re-hit Angle	Degree value for re-hit detection
01013	Zoom Step Speed	Can be in percent or RPM of tool maximal speed
01014	Ergo Ramp	Can be in percent or RPM of tool maximal speed
01015	Reserved	Reserved
01016	Tool Idle time	Time after rundown done until result is sent, especially used when Multistage tightening is used
01017	End Time	Time for slip off detection
01018	Monitor End Time from	When starting detection of End time. Cycle Start = 0 or Rundown Complete = 1
01019	Tight time out sec	Time out value in second before not finished Job is aborted.
01020	Max Coherent NOK	Max number of coherent NOK results allowed
01021	High Speed Rundown Used	Not used = 0, Used = 1
01022	High Speed Rundown Speed	Speed in percent of tool max
01023	High Speed Rundown Interval	Value in degrees for the interval of the first part of the rundown before snag
01024	High Speed Rundown Ramp at High Speed	Acceleration factor in percent
01025	High Speed Rundown Disable High Speed at NOK	No = 0, Yes = 1
01026	Options Used	No = 0, Yes = 1
01027	Options Soft Stop	Yes = 0, No = 1
01028	Options Re-hit Detect	No = 0, Yes = 1
01029	Options Torque < Target Detect	No = 0, Yes = 1
01030	Options Lost trigger detect	No = 0, Yes = 1
01031	Options Socket Release Detect	No = 0, Yes = 1
01032	Self-Tap Monitoring Speed Rpm	
01033	Measured Delay Time	
01034	Ds Tuning value	
01035	Options Timeout detect	
01036	Used strategies	Used strategies as a bit field. Measured value

Parameter id (PID)	Name	Description
01037	Tightening error bits 1	Tightening error bits show what went wrong with the tightening. Bit 1 Rundown angle max shut off Bit 2 Rundown angle min shut off Bit 3 Torque max shut off Bit 4 Angle max shut off Bit 5 Self-tap torque max shut off Bit 6 Self-tap torque min shut off Bit 7 Prevail torque max shut off Bit 8 Prevail torque min shut off Bit 9 Prevail torque compensate overflow Bit 10 Current monitoring max shut off Bit 11 Post view torque min torque shut off Bit 12 Post view torque max torque shut off Bit 13 Post view torque Angle too small Bit 14 Trigger lost Bit 15 Torque less than target Bit 16 Tool hot Bit 17 Multistage abort Bit 18 Rehit Bit 19 DS Measure failed Bit 20 Current limit reached Bit 21 End Time out shutoff Bit 22 Remove fastener limit exceeded Bit 23 Disable drive Bit 24 Transducer lost Bit 25 Transducer shorted Bit 26 Transducer corrupt Bit 27 Sync timeout Bit 28 Dynamic current monitoring min Bit 29 Dynamic current monitoring max Bit 30 Angle max monitor Bit 31 Yield nut off Bit 32 Yield too few samples

Parameter id (PID)	Name	Description
01038	Tightening error bits 2	Tightening error bits 2 shows what went wrong with the tightening. Bit 1 Drive deactivated Bit 2 Tool stall Bit 3 Drive hot Bit 4 Gradient monitoring high Bit 5 Gradient monitoring low Bit 6 Reaction bar failed Bit 7 Snug Max Bit 8 Cycle abort Bit 9 Necking failure Bit 10 Effective loosening Bit 11 Over speed Bit 12 No residual Torque Bit 13 Positioning fail Bit 14 Snug Mon. Low Bit 15 Snug Mon. High Bit 16 Dynamic Min. Current Bit 17 Dynamic Max. Current Bit 18 Latent result Bit 19-32 Reserved
01039	Result type	TIGHTENING_RES = 1 LOOSENING_RES = 2 SYNC_TIGHTENING_RES = 3 SYNC_LOOSENING_RES = 4 CLICK_WRENCH_RES = 5 INCREMENT_RES = 6 DECREMENT_RES = 7 RESET_BATCH_RES = 8 BYPASS_RES = 9 ABORT_JOB_RES = 10 EP_AUTOPROG_RES = 11 SYNC_NO_TIGHTENING_RES = 12 POSITIONING_RES = 13 EP_UNTUNED_RES = 14 LATE_RES = 15 TQ_WITH_NO_PSET_RES 16 RADIO_WORK_ORDER_ABORT 17 STW_LOOSENING_RES 18 RESTART_JOB_RES = 19
01040	Dynamic Pset Id	The Id of a dynamic Pset
01041	Dynamic Pset Name	The name of a dynamic Pset
01042	Tightening information bits	Device dependent tightening information. See specific device specification and/or appendix
01043	Disable loosening	Disable loosening = 0, Enable loosening = 1.

Unit /Parameter ID/Data Type definitions

Parameter id (PID)	Name	Description
01044	Tightening program valid to	Time when program expires, normally expressed in data type T. Note: If program is running when reaching expiration time, the program shall be finished before setting program to invalid.
01045	Validate software version	Check if software version in JSON string matches Controller version. Reject if not matched or if software version is missing in JSON string. (true or false)
01046	Checksum	A checksum calculated by controller or given be integrator. Used for integrity checks of interchanged data. Controller will reject operation if given checksum do not match calculated checksum. Typically to be used with MID2500 and MID2501
Torque controller information		
01100	Torque controller Name	The name of the torque controller that made the tightening
01101	Torque controller Number	The number of the torque controller that made the tightening.
01102	Torque controller type name	The type name of the controller that made the tightening.
01103	Torque controller article number	The article number of the torque controller that made the tightening. Will be sent as a string
01104	Torque controller serial number	The serial number of the torque controller that made the tightening. Will be sent as a string
Bolt information		
01300	Bolt Name	The name of the bolt that was tightened
01301	Bolt Number	The number of the bolt that was tightened
01302	Bolt Status	The status of the bolt that was tightened
Error and status codes		
01400	Tightening Status	The total status of the tightening 0 = Tightening NOK 1 = Tightening OK
01401	Tightening error codes	Error codes from the tightening. Is defined by a bit field and sent as a hexadecimal value, i.e. Data Type will be set to H in the telegram. The number of bits and their definition vary between the different systems.
01402	Torque status	The status of the Torque in the tightening Based on the parameter 02001 0=Low, 1=OK, 2=High
01403	Angle status	The status of the Angle in the tightening Based on the parameter 02011 0=Low, 1=OK, 2=High

Parameter id (PID)	Name	Description
01404	Rundown Monitor status	The status of the Rundown monitoring in the tightening Based on the parameters 02016-2018 0=Low, 1=OK, 2=High
01405	Current Monitor status	The status of the Current monitoring in the tightening Based on the parameters 02020-02023 0=Low, 1=OK, 2=High
01406	Self Tap Status	The status of the Self tap monitoring in the tightening Based on the parameters 02070-02071 0=Low, 1=OK, 2=High
01407	PVT Monitor status	The status of the PVT monitoring in the tightening Based on the parameter 02078 0=Low, 1=OK, 2=High
01408	PVT Comp status	The status of the PVT Comp monitoring in the tightening. Based on the parameters 02072-02073 0=Low, 1=OK, 2=High
01420	Tightening Status Additional Information	Additional information related to the Tightening Status Possible values are: 1 = Repaired 2 = Stopped 3 = Emergency Stopped 4 = Tool Error 5 = Drive Error 6 = Invalid Tightening Program 7 = PreStart Check Failed 8 = Terminated By Reject Management 9 = Reject Management Termination Failed 10 = Inhibited 11 = Reject Management Repair Failed
01421	Primary Error	The primary error from the tightening. The definition vary between the different systems, see description in section 6.4.1.
01422	Failing Step	The number of the step that made the tightening NOK
Job/ Sync parameters		
01500	Job ID	ID of a Job
01501	Job sequence number	Job result sequence
01502	Job stage number	Stage within an Job
01503	Job time stamp	The last time the Job configuration was changed
01504	Sync Group ID	Id of a sync group or station.
01505	Sync Group Name	Name of a sync group or station.
01506	Sync Group Status	Status of a sync group or station
01507	Sync Tightening Id	The Id of a result from an sync tightening
01508	Job Start Time	The time stamp of Job started

Unit /Parameter ID/Data Type definitions

Parameter id (PID)	Name	Description
01509	Job Reference Mac address	The Reference Mac address for Job result when cell is used
01510	Job result Id	Identifier number of Job
01511	Auto Pset change	A Boolean. 1 =Auto change 0= BY hand
01512	Pset/Mset type	
01513	Pset/Mset channel Id	Channel Id of Pset/Mset when cell is used
01514	Stop time	Time when the Job was ended or stopped
01515	First NOK Event	First NOK stage in Job
01516	Job done status	0 = Job off, 1 = Running, 2 = OK, 3 = NOK, 4 = ABORTED
Alarm information		
01700	Alarm text	Alarm text, sent as String
01701	Alarm severity	Severity of the alarm, possible values are: 1 = Info 2 = Warning 3 = Error
01702	Maintenance alert	Maintenance alert, possible values are: 0 = No, 1 = Yes
Tightening values		
02000	Torque, final target	The target torque for the whole tightening program
02001	Torque, measured value	The measured torque for the whole tightening.
02002	Torque, final upper limit	The upper limit for the measured torque of the whole program.
02003	Torque, final lower limit	The lower limit for the measured torque of the whole program.
02004	Torque, first target	The first target in a two step
02005	Torque, cycle start	Torque value where the tightening measurement starts after tightening start
02006	Torque, cycle complete	Torque value where the tightening measurement starts before complete
02008	Rundown start torque	Torque, Rundown start torque
02009	Final angle start torque	Torque, Final angle start torque
02010	Angle, target	The target angle for the whole tightening program
02011	Angle, measured value	The measured angle for the whole tightening.
02012	Angle, upper limit	The upper limit for the measured angle, for the whole tightening
02013	Angle, lower limit	The lower limit for the measured angle, for the whole tightening
02014	Angle target threshold torque cycle start	The torque value at which the angle measurement start at the cycle start

Parameter id (PID)	Name	Description
02015	Angle target threshold torque cycle end	The torque value at which the angle measurement start at the cycle end
02016	Angle Max Rundown	The max allowed angle value target measured according to parameter 2043
02017	Angle Min Rundown	The min angle allowed value target measured according to parameter 2043
02018	Angle max to monitor	The max value of the angle to measure
02019	Torque, Rundown complete torque	
02020	Current, target	The target current for the whole tightening program
02021	Current, measured value	The measured current for the whole tightening.
02022	Current, upper limit	The upper limit for the measured current
02023	Current, lower limit	The lower limit for the measured current
02030	Torque 2 nd , measured value	The measured torque for the whole tightening. Measured with a secondary torque transducer.
02031	Torque 2 nd , upper limit	The upper limit for the measured torque 2 nd .
02032	Torque 2 nd , lower limit	The lower limit for the measured torque 2 nd .
02033	Monitoring Torque, measured value	The final measured torque value from the monitoring torque transducer
02034	Torque transducer number, controlling	The number of the controlling torque transducer. Specified by one ASCII digit (1-9). For a tool with only one torque transducer then 1 or space can be used.
02035	Torque transducer number, monitoring	The number of the monitoring torque transducer. Specified by one ASCII digit (1-9). For a tool with only one torque transducer then 1 or space can be used.
02040	Angle 2 nd , measured value	The measured angle for the whole tightening. Measured with a secondary angle transducer.
02041	Angle 2 nd , upper limit	The upper limit for the measured angle 2 nd
02042	Angle 2 nd , lower limit	The lower limit for the measured angle 2 nd
02043	Rundown Angle	The rundown angle selection is = 0 (No), 1 (From start) and 2 (From cycle start)
02044	Rundown Angle measured value	
02045	Monitoring Angle, measured value	The final measured angle value from the monitoring torque transducer
02046	Angle transducer number, controlling	The number of the controlling angle transducer. Specified by one ASCII digit (1-9). For a tool with only one torque transducer then 1 or space can be used.
02047	Angle transducer number, monitoring	The number of the monitoring angle transducer. Specified by one ASCII digit (1-9). For a tool with only one torque transducer then 1 or space can be used.
02050	Speed, target	The target speed for the whole tightening program
02051	Speed, measured	The measured speed for the whole tightening program
02052	Step Speed	The target speed for the each step

Unit /Parameter ID/Data Type definitions

Parameter id (PID)	Name	Description
02053	Reserved	Reserved
02054	Soft start time	The time duration for the soft start in a tightening
02055	Soft start speed	The tightening speed during the soft start time duration either in ratio or percent of the tool max speed.
02056	Step Ramp	The tightening speed increase per time unit during the step.
02057	Reserved	Reserved
02058	Lock at batch done	0 = No, 1 = Yes
02059	Necking shut off	Antinecking detection for angle control strategies. 0 = No, 1= Yes
02060	Rotate Direction	CW = 1, CCW = 2
02061	Self-tap	Self-tap on or off 0 = off, 1= on
02062	Number of self-tap windows	At least 1
02064	Necking drop torque from peak	
02070	Self-tap Max Torque	The max tightening torque value for the self-tap measurement validation.
02071	Self-tap Min Torque	The min tightening torque value for the self-tap measurement validation.
02072	Prevail Torque Max	The max tightening torque value for the prevail measurement validation.
02073	Prevail Torque Min	The min tightening torque value for the prevail measurement validation.
02074	Yield Max	
02075	Yield Min	
02076	Prevail	Prevail on or off 0 = off, 1= on
02077	Prevail Comp	Prevail Comp on or off 0 = off, 1= on
02078	Prevail comp point angle	Angle value
02079	Number of prevail windows	At least 1 is required
02080	Post View Torque Min Limit	Torque float value for the low limit in Torque trace
02081	Post View Torque Max Limit	Torque float value for the high limit inn Torque trace
02082	Prevail Comp Measured Torque	
02084	Self-tap monitor interval	The interval duration in degrees for self-tap measurements according to parameters 02070 and 02071
02085	Prevail Torque Delay Interval	Delay from cycle start to the start of Prevail Torque Monitor Interval
02086	Prevail Torque Monitor Interval	The interval duration in degrees for prevail measurements according to parameters 02072 and 02073
02087	Post View Torque Monitor Min Start	Post View Torque in Angle trace
02088	Post View Torque Monitor Min Interval	Post View Torque in Angle trace
02089	Post View Torque Monitor Max Start	Post View Torque in Angle trace

Parameter id (PID)	Name	Description
02090	Post View Torque Monitor Max Interval	Post View Torque in Angle trace
02091	Post View Torque	Post View Torque monitoring on or off 0 = off, 1= on
02092	Self-tap Torque measured value	
02093	Prevail Torque measured value	
02094	Attachment Gear ratio	
02095	Attachment tuning. Efficiency tuning	
02100	Loosening limit torque	Torque threshold for loosening detection
02101	Loosening speed	Speed according to parameter 02103
02102	Loosening ramp	Ramp according to parameter 02103
02103	Speed unit	Unit for speed in percent = 0 or rpm = 1
02110	Force, final target	The target force for the whole program
02111	Force, measured value	The measured force for the whole press.
02112	Force, final upper limit	The upper limit for the measured force, for the whole program
02113	Force, final lower limit	The lower limit for the measured force. For the whole program
02120	Stroke, target	The target stroke for the whole program
02121	Stroke, measured value	The measured stroke for the whole program.
02122	Stroke, upper limit	The upper limit for the measured stroke, for the whole program
02123	Stroke, lower limit	The lower limit for the measured stroke, for the whole program
02124	Free Event Text	User defined event text
02130	Four stage soft start angle	Starting value in degrees for an four stage tightening
02131	Four stage soft start angle torque max	Max value for soft start torque in Nm during soft start
02132	Four stage first target angle min	Min value in degrees for first target in an four stage tightening
02133	Four stage first target angle max	Max value in degrees for first target in an four stage tightening
02134	Four stage torque, measured value	The measured torque for one stage of a four stage tightening
02135	Four stage angle, measured value	The measured angle for one stage of a four stage tightening
02136	Four stage status angle, measured value	The status for one stage angle of a four stage tightening. Value = 0 = NOK. Value = 1 = OK.
02129	Four stage status torque measured value	The status for one stage torque of a four stage tightening. Value = 0 = NOK. Value = 1 = OK.

Unit /Parameter ID/Data Type definitions

Parameter id (PID)	Name	Description
02137	Gradient monitoring	Gradient monitoring on or off 0 = off, 1= on
02138	Gradient torque min	Torque Value in Nm
02139	Gradient torque max	Torque Value in Nm
02140	Gradient Joint hardness	Angle value in degrees
02141	Gradient Start torque	Torque value in Nm
02142	Gradient Angle offset	Angle value in degrees
02143	Yield control Start torque	Torque value in Nm
02144	Yield control Step angle	Angle value in degrees for one step
02145	Yield control window angle	Angle value in degrees
02146	Yield slope ratio	In percent
02147	Yield control Extra Angle step	Angle extra value for one step
02150	Positioning Adjustable limit	Adjustable limit on or off. 0 = off, 1= on
02151	Positioning limit	Value in Nm
02152	Snug gradient delta angle	Value in degrees
02153	Snug gradient delta torque	Value in torque Nm
02154	Snug gradient Torque limit	Value in torque Nm
02155	Snug gradient PVT distance	Value in degrees
02156	Snug gradient PVT interval	Value in degrees
02157	Snug gradient Compensate	Value in degrees
02158	Snug PVT Monitoring min	Value in torque Nm
02159	Snug PVT Monitoring max	Value in torque Nm
02160	Delay monitoring after cycle start	Value in degrees
02161	Four stage soft start angle low limit	Min value in degrees for soft start angle in a four stage tightening
02162	Four stage soft start angle high limit	Max value in degrees for soft start angle in a four stage tightening
02163	Four stage rundown torque low limit	Min value in Nm for rundown torque in a four stage tightening
02164	Four stage rundown torque high limit	Max value in Nm for rundown torque in a four stage tightening
02165	Four stage first torque low limit	Min value in Nm for first torque in a four stage tightening
02166	Four stage first torque high limit	Max value in Nm for first torque in a four stage tightening
02167	Four stage soft start angle torque min	Min value for soft start torque in Nm during soft start
02170	Elapsed time	Total time to make the tightening [s]
02171	Turns for rundown	Number of turns for rundown
<i>Tightening values for trace</i>		

Parameter id (PID)	Name	Description
02201	Trace type	Type of the trace curve 1 = Angle trace 2 = Torque trace 3 = Current trace 4 = Gradient trace 5 = Stroke trace 6 = Force
02213	Coefficient	Coefficient to convert 2 byte binary data to real physical values. Physical value = Binary value / Coefficient
02214	Coefficient	Coefficient to convert 2 byte binary data to real physical values. Physical value = Binary value * Coefficient
02215	Stage one number of samples	Number of samples for stage one at four stage tightening
02216	Stage two number of samples	Number of samples for stage two at four stage tightening
02217	Stage three number of samples	Number of samples for stage three at four stage tightening
02218	Stage four number of samples	Number of samples for stage four at four stage tightening
General download data status for Radio Connected Tools		
04000	Tool latest Pset status	A Boolean = 0 Latest Pset failed to tool. 1 = Latest Pset success to tool
04001	Tool latest Identifier status	A Boolean 0 = Latest Identifiers failed to tool, 1= Success to tool
04002	Tool lock/unlock status	A Boolean = 0 = Tool unsuccessfully locked/unlocked 1 = Tool successfully locked/unlocked
Step information		

Parameter id (PID)	Name	Description
05000	Tightening step strategy	The overall strategy used in the tightening program step Possible strategies are: 01=Torque control 02=Angle control 03=Backlash correction 04=Diagnostic 05=DynaTork 06=Engage 07=JOG 08=Run to position 09=Run until snug 10=Socket release 11=Time control 12=Wait 13=Yield point 14=Torque Or Angle control 15=Torque Plus Angle control 16=Torque And Angle control 17=Rundown 18=TurboTight 19=Digital Input 20=External Result
05001	Step error codes	Error codes from the tightening program step. Is defined by a bit field and sent as a hexadecimal value, i.e. Data Type will be set to H in the telegram. The number of bits and their definition vary between the different systems.
05002	Step name	Name of the tightening program step
05003	Step Status	The total status of the step 0 = Step NOK 1 = Step OK
05004	Step Primary Error	The primary error from the step tightening. The definition vary between the different systems, see description in section 6.4.1.
Step Tightening values		
05100	Step Torque, target	The target torque for the tightening program step
05101	Step Torque, measured value	The measured torque for the tightening program step
05102	Step Torque, upper limit	The upper limit for the measured step torque.
05103	Step Torque, lower limit	The lower limit for the measured step torque.
05110	Step Angle, target	The target angle for the tightening program step
05111	Step Angle target threshold torque	The torque value there the angle measurement start
05112	Step Angle, measured value	The measured angle for tightening program step
05113	Step Angle, upper limit	The upper limit for the measured step angle
05114	Step Angle, lower limit	The lower limit for the measured step angle
05120	Step Current, target	The target current for the tightening program step

Parameter id (PID)	Name	Description
05121	Step Current, measured value	The measured current for tightening program step
05122	Step Current, upper limit	The upper limit for the measured step current
05123	Step Current, lower limit	The lower limit for the measured step current
05130	Step Force, target	The target force for the tightening program step
05131	Step Force, measured value	The measured force for the tightening program step
05132	Step Force, upper limit	The upper limit for the measured step force.
05133	Step Force, lower limit	The lower limit for the measured step force.
05140	Step Stroke, target	The target stroke for the tightening program step
05141	Step Stroke target threshold force	The force value there the stroke measurement start
05142	Step Stroke, measured value	The measured stroke for tightening program step
05143	Step Stroke, upper limit	The upper limit for the measured step stroke
05144	Step Stroke, lower limit	The lower limit for the measured step stroke
05150	Step Start	Calculated from the Time Stamp
05151	Step Stop	Calculated from the Time Stamp
05160	Step Shut Off Torque, measured	The measured shut off torque for the step
05161	Step Torque Rate, measured	The measured torque rate for the step
05162	Step Torque Rate Deviation, measured	The measured torque rate deviation for the step
05163	Step Peak Torque in Window, measured	The measured peak torque in angle window for the step
05164	Step Low Torque in Window, measured	The measured low torque in angle window for the step
05165	Step Post View Torque High, measured	The measured post view torque high torque value for the step
05166	Step Post View Torque Low, measured	The measured post view torque low torque value for the step
05167	Step Yield Angle, measured	The measured yield point angle for the step
05168	Step Prevailing Torque, measured	The measured prevailing torque for the step
05169	Step Time, measured	The measured time for the step
05170	Step Elapsed Time	Time needed to execute the step
05171	Cross Thread Angle, measured	The measured cross thread angle for the step
05172	Step Post View Torque High Angle, measured	The measured angle at post view torque high
05173	Step Post View Torque Low Angle, measured	The measured angle at post view torque low
05174	Step Delta Torque, measured	The measured delta torque for the step
05175	Step Low Spot, measured	The measured low spot torque for the step

Table 235 Tool Information PID list

01200	Tool type name	The type name of the tool that made the tightening. Could for example be "QST50-150CTT"
01201	Tool article number	The article number of the tool that made the tightening. Will be sent as a string
01202	Tool serial number	The serial number of the tool that made the tightening. Will be sent as a string
01203	Tool type	00=No Tool, 01=S-tool, 02=DS-tool, 03=Ref. transducer, 04=ST-tool, 05=EP-tool, 06=ETX-tool, 07=SL-tool, 08=DL-tool, 09=IRC Offline, 10=STB-tool, 11=QST-tool, 12=SST-tool, 13=ST wrench, 14 = ES-tool, 15 = ESB, 16 = SB, 17 = SB+, 18 = PST, 19 = STR, 20 = ETD M, 21 = ETD MC, 22 = ETD MT, 23 = QMC, 24 = QMT, 25 = BCV-RE, 26 = BCP-RE, 27 = E-LIT, 28 = ISB, 29 = ITB, 30 = ITP, 31 = Qshield-C, 32 = DeltaWrench, 33 = STRWrench, 34 = XPBM, 35 = ExBC, 36 = ExD
01204	Speed Factor	
01205	Tool number	The index or number of the tool
01210	Tool total number of tightenings	The total number of tightenings made with the tool
01211	Tool total number of tightenings since service	The total number of tightenings made with the tool since last service, possible values are: 1 = Reset tightenings since last service 0 = To do nothing
01212	Tool total number of tightenings to service	The total number of tightenings before the tool need to be serviced
01213	Tool Temperature	To read out the different tool temperatures
01214	Service Interval	To get the service interval
01215	Battery: State of charge	Number: 0 to 4 (0 is empty, 4 is full)
01216	Battery: State of health	Number: 0 to 2
01217	Battery: Product number	Handled as a string
01218	Battery: First usage day	Handled as a string
01219	MAC address of the tool	The MAC address of the tool connected to the Virtual Station
01220	Tool connection status	The tool connection status for the Virtual Station

6.4.1 Tightening error definition

In the fields Tightening Errors and Primary Tightening Errors on program level and step level the same definition of the errors are used.

The error code is laid out as a bit field there each bit represent one error according to device specific definition, an example can be found in Table 236. In Tightening errors all the errors that occurred in the program or step are sent together. In Primary Tightening Error only the

most significant error is sent, i.e. the error that caused the NOK. This might differ between devices, always consult the device specific documentation.

The definition is used in the following PIDs, there each PID is sent as a hexadecimal value:

- PID 01401 - Tightening error codes
- PID 01421 - Primary Error
- PID 05001 - Step error codes
- PID 05004 - Step Primary Error

Table 236 Example of definitions for tightening error codes

Error Code	Value
BrakeFailed	0x0000 0000 0000 0000 0000 0000 0000 0001
TriggerLost	0x0000 0000 0000 0000 0000 0000 0000 0002
ShuntFailed	0x0000 0000 0000 0000 0000 0000 0000 0004
ZeroOffsetFailed	0x0000 0000 0000 0000 0000 0000 0000 0008
EngageFailed	0x0000 0000 0000 0000 0000 0000 0000 1000
PeakTorque_TorqueNotMeasured	0x0000 0000 0000 0000 0000 0000 0001 0000
PeakTorque_TorqueLow	0x0000 0000 0000 0000 0000 0000 0002 0000
PeakTorque_TorqueHigh	0x0000 0000 0000 0000 0000 0000 0004 0000
ShutOffTorque_TorqueLow	0x0000 0000 0000 0000 0000 0000 0008 0000
ShutOffTorque_TorqueHigh	0x0000 0000 0000 0000 0000 0000 0010 0000
TorqueRate_TorqueRateNotMeasured	0x0000 0000 0000 0000 0000 0000 0020 0000
TorqueRate_TorqueRateLow	0x0000 0000 0000 0000 0000 0000 0040 0000
TorqueRate_TorqueRateHigh	0x0000 0000 0000 0000 0000 0000 0080 0000
TorqueRate_TorqueRateDeviationTooBig	0x0000 0000 0000 0000 0000 0000 0100 0000
TorqueRate_TorqueRateDeviationNotMeasured	0x0000 0000 0000 0000 0000 0000 0200 0000
StepMonitorAngle_AngleNotMeasured	0x0000 0000 0000 0000 0000 0000 0400 0000
StepMonitorAngle_AngleLow	0x0000 0000 0000 0000 0000 0000 0800 0000
StepMonitorAngle_AngleHigh	0x0000 0000 0000 0000 0000 0000 1000 0000
TorqueInAngleWindow_TorqueNotMeasured	0x0000 0000 0000 0000 0000 0000 2000 0000
TorqueInAngleWindow_TorqueLow	0x0000 0000 0000 0000 0000 0000 4000 0000
TorqueInAngleWindow_TorqueHigh	0x0000 0000 0000 0000 0000 0000 8000 0000
PostViewAverageTorqueHigh_TorqueNotMeasured	0x0000 0000 0000 0000 0000 0001 0000 0000
PostViewAverageTorqueHigh_TorqueHigh	0x0000 0000 0000 0000 0000 0002 0000 0000
PostViewAverageTorqueLow_TorqueNotMeasured	0x0000 0000 0000 0000 0000 0004 0000 0000
PostViewAverageTorqueLow_TorqueLow	0x0000 0000 0000 0000 0000 0008 0000 0000
YieldAngle_AngleNotMeasured	0x0000 0000 0000 0000 0000 0010 0000 0000
YieldAngle_AngleLow	0x0000 0000 0000 0000 0000 0020 0000 0000
YieldAngle_AngleHigh	0x0000 0000 0000 0000 0000 0040 0000 0000
StickSlipDetection_DropBelowTrigger	0x0000 0000 0000 0000 0000 0080 0000 0000
ShutOffCurrent_CurrentLow	0x0000 0000 0000 0000 0000 0100 0000 0000
ShutOffCurrent_CurrentHigh	0x0000 0000 0000 0000 0000 0200 0000 0000

Unit /Parameter ID/Data Type definitions

Error Code	Value
PrevailingTorque_TorqueNotMeasured	0x0000 0000 0000 0000 0000 0400 0000 0000
PrevailingTorque_TorqueLow	0x0000 0000 0000 0000 0000 0800 0000 0000
PrevailingTorque_TorqueHigh	0x0000 0000 0000 0000 0000 1000 0000 0000
StepMonitorTime_TimeNotMeasured	0x0000 0000 0000 0000 0000 2000 0000 0000
StepMonitorTime_TimeLow	0x0000 0000 0000 0000 0000 4000 0000 0000
StepMonitorTime_TimeHigh	0x0000 0000 0000 0000 0001 0000 0000 0000
StepRestrictionTorqueHigh	0x0000 0000 0000 0001 0000 0000 0000 0000
StepRestrictionAngleHigh	0x0000 0000 0000 0002 0000 0000 0000 0000
StepRestrictionTimeHigh	0x0000 0000 0000 0004 0000 0000 0000 0000
StepRestrictionCrossThread_AngleLow	0x0000 0000 0000 0008 0000 0000 0000 0000
StepRestrictionCrossThread_AngleHigh	0x0000 0000 0000 0010 0000 0000 0000 0000
StepRestrictionTorqueGradient_GradientLow	0x0000 0000 0000 0020 0000 0000 0000 0000
StepRestrictionTorqueGradient_GradientHigh	0x0000 0000 0000 0040 0000 0000 0000 0000
StepRestrictionTorqueLow	0x0000 0000 0000 0080 0000 0000 0000 0000
ExcessiveAngularRotation_PositiveReached	0x0000 0000 0000 0100 0000 0000 0000 0000
ExcessiveAngularRotation_NegativeReached	0x0000 0000 0000 0200 0000 0000 0000 0000
CurrentDeviation	0x0000 0000 0000 0400 0000 0000 0000 0000
StepRestrictionTorqueInAngleWindow_TorqueHigh	0x0000 0000 0000 0800 0000 0000 0000 0000
StepRestrictionTorqueInAngleWindow_TorqueLow	0x0000 0000 0000 1000 0000 0000 0000 0000
Rehit	0x0000 0000 0000 2000 0000 0000 0000 0000
ProgramRestrictionTorqueHigh	0x0000 0001 0000 0000 0000 0000 0000 0000
ProgramRestrictionTimeHigh	0x0000 0002 0000 0000 0000 0000 0000 0000
ProgramMonitorAngle_AngleNotMeasured	0x0001 0000 0000 0000 0000 0000 0000 0000
ProgramMonitorAngle_AngleHigh	0x0002 0000 0000 0000 0000 0000 0000 0000
ProgramMonitorAngle_AngleLow	0x0004 0000 0000 0000 0000 0000 0000 0000

6.5 Systems Unique Parameter ID number series

Below is shown parameter IDs areas that are dedicated for systems special needs, NOT common for all systems using open protocol. The exact use shall be described in the product/system Open Protocol implementation description documents.

Format: 5 ASCII digits

Table 237 Parameter IDs definitions system unique

System	First PID	Last PID
PF4000	10000	14999
PM4000	15000	19999
PF6000	20000	24999
CVI	25000	29999
Micro Torque	30000	34999
Integrator Specific	35000	39999
PFHC	40000	44999

7 Appendix













7.1 Message part numbering table

Dec	Hex	Character	Description	Message part number
0	0	NUL	Null	
1	1	SOH	Start of Heading	
2	2	STX	Start of Text	
3	3	ETX	End of Text	
4	4	EOT	End of Transmission	
5	5	ENQ	Enquiry	
6	6	ACK	Acknowledge	
7	7	BEL	Bell	
8	8	BS	Backspace	
9	9	HT	Horizontal Tab	
10	0A	LF	NL Line Feed, New Line	
11	0B	VT	Vertical Tab	
12	0C	FF	NP Form Feed, New Page	
13	0D	CR	Carriage Return	
14	0E	SO	Shift Out	
15	0F	SI	Shift In	
16	10	DLE	Data Link Escape	
17	11	DC1	Device Control 1	
18	12	DC2	Device Control 2	
19	13	DC3	Device Control 3	
20	14	DC4	Device Control 4	
21	15	NAK	Negative Acknowledge	
22	16	SYN	Synchronous Idle	
23	17	ETB	End of Transmission Block	
24	18	CAN	Cancel	
25	19	EM	End of Medium	
26	1A	SUB	Substitute	
27	1B	ESC	Escape	
28	1C	FS	File Separator	
29	1D	GS	Group Separator	
30	1E	RS	Record Separator	
31	1F	US	Unit Separator	
32	20	(Space)	Space	Not used
33	21	!	Exclamation Mark	70

Dec	Hex	Character	Description	Message part number
34	22	"	Double Quote	71
35	23	#	Hash or Number	72
36	24	\$	Dollar Sign	73
37	25	%	Percentage	74
38	26	&	Ampersand	75
39	27	'	Single Quote	76
40	28	(Left Parenthesis	77
41	29)	Right Parenthesis	78
42	2A	*	Asterisk	79
43	2B	+	Plus Sign	80
44	2C	,	Comma	81
45	2D	-	Minus Sign	82
46	2E	.	Period	83
47	2F	/	Slash	84
48	30	0	Zero	Not used
49	31	1	Number One	1
50	32	2	Number Two	2
51	33	3	Number Three	3
52	34	4	Number Four	4
53	35	5	Number Five	5
54	36	6	Number Six	6
55	37	7	Number Seven	7
56	38	8	Number Eight	8
57	39	9	Number Nine	9
58	3A	:	Colon	85
59	3B	;	Semicolon	86
60	3C	<	Less Than	87
61	3D	=	Equals Sign	88
62	3E	>	Greater Than	89
63	3F	?	Question Mark	90
64	40	@	At Sign	91
65	41	A	Upper Case Letter A	10
66	42	B	Upper Case Letter B	11
67	43	C	Upper Case Letter C	12
68	44	D	Upper Case Letter D	13
69	45	E	Upper Case Letter E	14
70	46	F	Upper Case Letter F	15
71	47	G	Upper Case Letter G	16
72	48	H	Upper Case Letter H	17
73	49	I	Upper Case Letter I	18

Dec	Hex	Character	Description	Message part number
74	4A	J	Upper Case Letter J	19
75	4B	K	Upper Case Letter K	20
76	4C	L	Upper Case Letter L	21
77	4D	M	Upper Case Letter M	22
78	4E	N	Upper Case Letter N	23
79	4F	O	Upper Case Letter O	24
80	50	P	Upper Case Letter P	25
81	51	Q	Upper Case Letter Q	26
82	52	R	Upper Case Letter R	27
83	53	S	Upper Case Letter S	28
84	54	T	Upper Case Letter T	29
85	55	U	Upper Case Letter U	30
86	56	V	Upper Case Letter V	31
87	57	W	Upper Case Letter W	32
88	58	X	Upper Case Letter X	33
89	59	Y	Upper Case Letter Y	34
90	5A	Z	Upper Case Letter Z	35
91	5B	[Left Square Bracket	36
92	5C	\	Backslash	37
93	5D]	Right Square Bracket	38
94	5E	^	Caret or Circumflex	39
95	5F	_	Underscore	
96	60	`	Grave Accent	
97	61	a	Lower Case Letter a	40
98	62	b	Lower Case Letter b	41
99	63	c	Lower Case Letter c	42
100	64	d	Lower Case Letter d	43
101	65	e	Lower Case Letter e	44
102	66	f	Lower Case Letter f	45
103	67	g	Lower Case Letter g	46
104	68	h	Lower Case Letter h	47
105	69	i	Lower Case Letter i	48
106	6A	j	Lower Case Letter j	49
107	6B	k	Lower Case Letter k	50
108	6C	l	Lower Case Letter l	51
109	6D	m	Lower Case Letter m	52
110	6E	n	Lower Case Letter n	53
111	6F	o	Lower Case Letter o	54
112	70	p	Lower Case Letter p	55
113	71	q	Lower Case Letter q	56

Dec	Hex	Character	Description	Message part number
114	72	r	Lower Case Letter r	57
115	73	s	Lower Case Letter s	58
116	74	t	Lower Case Letter t	59
117	75	u	Lower Case Letter u	60
118	76	v	Lower Case Letter v	61
119	77	w	Lower Case Letter w	62
120	78	x	Lower Case Letter x	63
121	79	y	Lower Case Letter y	64
122	7A	z	Lower Case Letter z	65
123	7B	{	Left Curly Bracket	66
124	7C		Vertical Bar	67
125	7D	}	Right Curly Bracket	68
126	7E	~	Tilde	69
127	7F	DEL	Delete	
128		Ç	Latin Capital Letter C With Cedilla	
129		ü	Latin Small Letter U With Diaeresis	
130		é	Latin Small Letter E With Acute	
131		â	Latin Small Letter A With Circumflex	
132		ä	Latin Small Letter A With Diaeresis	
133		à	Latin Small Letter A With Grave	
134		å	Latin Small Letter A With Ring Above	
135		ç	Latin Small Letter C With Cedilla	
136		ê	Latin Small Letter E With Circumflex	
137		ë	Latin Small Letter E With Diaeresis	
138		è	Latin Small Letter E With Grave	
139		ï	Latin Small Letter I With Diaeresis	
140		î	Latin Small Letter I With Circumflex	
141		ì	Latin Small Letter I With Grave	
142		Ä	Latin Capital Letter A With Diaeresis	
143		Å	Latin Capital Letter A With Ring Above	
144		É	Latin Capital Letter E With Acute	
145		§	Latin Small Letter Ae	
146		Æ	Latin Capital Letter Ae	
147		ô	Latin Small Letter O With Circumflex	
148		ö	Latin Small Letter O With Diaeresis	
149		ò	Latin Small Letter O With Grave	
150		û	Latin Small Letter U With Circumflex	
151		ù	Latin Small Letter U With Grave	
152		ÿ	Latin Small Letter Y With Diaeresis	
153		Ö	Latin Capital Letter O With Diaeresis	

Dec	Hex	Character	Description	Message part number
154		Û	Latin Capital Letter U With Diaeresis	
155		¢	Cent Sign	
156		£	Pound Sign, Pound Sterling, Irish Punt, Lira Sign	
157		¥	Yen Sign, Yuan Sign	
158		₧	Peseta Sign	
159		ƒ	Latin Small Letter F With Hook, Florin Currency Symbol, Function Symbol	
160		á	Latin Small Letter A With Acute	
161		í	Latin Small Letter I With Acute	
162		ó	Latin Small Letter O With Acute	
163		ú	Latin Small Letter U With Acute	
164		ñ	Latin Small Letter N With Tilde, Small Letter Enye	
165		Ñ	Latin Capital Letter N With Tilde, Capital Letter Enye	
166		ª	Feminine Ordinal Indicator	
167		º	Masculine Ordinal Indicator	
168		¿	Inverted Question Mark, Turned Question Mark	
169		¬	Reversed Not Sign, Beginning Of Line	
170		⎯	Not Sign, Angled Dash	
171		½	Vulgar Fraction One Half	
172		¼	Vulgar Fraction One Quarter	
173		¡	Inverted Exclamation Mark	
174		«	Left-Pointing Double Angle Quotation Mark, Left Guillemet, Chevrons	
175		»	Right-Pointing Double Angle Quotation Mark, Right Guillemet	
176			Light Shade	
177			Medium Shade, Speckles Fill, Dotted Fill	
178			Dark Shade	
179			Box Drawings Light Vertical	
180			Box Drawings Light Vertical And Left	
181			Box Drawings Vertical Single And Left Double	
182			Box Drawings Vertical Double And Left Single	
183			Box Drawings Down Double And Left Single	
184			Box Drawings Down Single And Left Double	
185			Box Drawings Double Vertical And Left	
186			Box Drawings Double Vertical	
187			Box Drawings Double Down And Left	
188			Box Drawings Double Up And Left	

Dec	Hex	Character	Description	Message part number
189		⌋	Box Drawings Up Double And Left Single	
190		⌌	Box Drawings Up Single And Left Double	
191		⌍	Box Drawings Light Down And Left	
192		⌎	Box Drawings Light Up And Right	
193		⌏	Box Drawings Light Up And Horizontal	
194		⌐	Box Drawings Light Down And Horizontal	
195		⌑	Box Drawings Light Vertical And Right	
196		⌒	Box Drawings Light Horizontal	
197		⌓	Box Drawings Light Vertical And Horizontal	
198		⌔	Box Drawings Vertical Single And Right Double	
199		⌕	Box Drawings Vertical Double And Right Single	
200		⌖	Box Drawings Double Up And Right	
201		⌗	Box Drawings Double Down And Right	
202		⌘	Box Drawings Double Up And Horizontal	
203		⌙	Box Drawings Double Down And Horizontal	
204		⌚	Box Drawings Double Vertical And Right	
205		⌛	Box Drawings Double Horizontal	
206		⌜	Box Drawings Double Vertical And Horizontal	
207		⌝	Box Drawings Up Single And Horizontal Double	
208		⌞	Box Drawings Up Double And Horizontal Single	
209		⌟	Box Drawings Down Single And Horizontal Double	
210		⌠	Box Drawings Down Double And Horizontal Single	
211		⌡	Box Drawings Up Double And Right Single	
212		⌢	Box Drawings Up Single And Right Double	
213		⌣	Box Drawings Down Single And Right Double	
214		⌤	Box Drawings Down Double And Right Single	
215		⌥	Box Drawings Vertical Double And Horizontal Single	
216		⌦	Box Drawings Vertical Single And Horizontal Double	
217		⌧	Box Drawings Light Up And Left	
218		⌨	Box Drawings Light Down And Right	
219		█	Full Block, Solid Block	
220		▀	Lower Half Block	
221		▁	Left Half Block	

Dec	Hex	Character	Description	Message part number
222		▬	Right Half Block	
223		▬	Upper Half Block	
224		α	Greek Small Letter Alpha	85
225		ß	Latin Small Letter Sharp S, Eszett	86
226		Γ	Greek Capital Letter Gamma	87
227		π	Greek Small Letter Pi	88
228		Σ	Greek Capital Letter Sigma	89
229		σ	Greek Small Letter Sigma	90
230		μ	Micro Sign	91
231		τ	Greek Capital Letter Tau	92
232		Φ	Greek Capital Letter Phi	93
233		Θ	Greek Capital Letter Theta	94
234		Ω	Greek Capital Letter Omega	95
235		δ	Greek Small Letter Delta	96
236		∞	Infinity	97
237		φ	Greek Small Letter Phi	98
238		ε	Greek Small Letter Epsilon	99
239		∩	Intersection	
240		≡	Identical To	
241		±	Plus-Minus Sign	
242		≥	Greater-Than Or Equal To	
243		≤	Less-Than Or Equal To	
244		∫	Top Half Integral	
245		∫	Bottom Half Integral	
246		÷	Division Sign, Obelus	
247		≈	Almost Equal To, Asymptotic To	
248		°	Degree Sign	
249		·	Bullet Operator	
250		·	Middle Dot, Interpunct	
251		√	Square Root, Radical Sign	
252		ⁿ	Superscript Latin Small Letter N	
253		²	Superscript Two, Squared	
254		■	Black Square	
255			Non-Breaking Space, NBSP	